

Siemens offers a full line of custom belt scales and weighfeeder systems guaranteed to fit your application. Take a look at the MUS universal belt scale system or the heavyweight, NTEP-approved MMI multi-idler belt scale system for custody transfer applications. With the right combination of belt scales, weighfeeders, integrators, and speed sensors, you can build the perfect configuration for your plant. And, with Siemens software, you can configure your integrator using a Windows-based laptop PC.

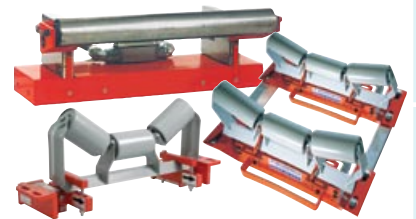

	Prices Start at	See Page
Belt Scales		
Siemens MBS Modular Basic Medium Duty Belt Scale	\$1007.00	286
Siemens MCS Compact Stainless Steel Modular Belt Scale	\$2460.00	286
Siemens MLC Light Duty Monitoring Single Idler Belt Scale	\$4819.00	286
Siemens MMI Heavy Duty NTEP-Approved Multi-Idler Belt Scale	Call	286
Siemens MSI Heavy Duty Single Idler Belt Scale	\$3164.00	286
Siemens MUS Universal Single Idler Belt Scale	\$1642.00	286
Siemens WD600 Slider Bed Belt Scale	\$3762.00	287

SIEMENS



Motion Failure Alarms and Speed Switches		
Siemens MFA 4p Motion Failure Alarm Monitor	\$352.00	284
Siemens MFA-4p Compatible Motion Sensing Probes	\$201.00	284
Siemens ZSS Zero Speed Switch	\$469.00	285



Solids Flowmeters		
Siemens A Series Flowmeters for Aerated Gravity Conveyors	Call	290
Siemens E Series Flowmeters for Fine Powders	Call	290
Siemens V Series Vertical Flowmeters for Fine Powders	Call	290



Solids Flow Control Systems		
Siemens SITRANS AS100 Acoustic Sensor for Bulk Solids Flow	\$757.00	282
Siemens SITRANS CU-02 Control Unit	\$513.00	282



Weighfeeders		
Siemens Series 400 (9" to 12" Belt Width) Weighfeeder	Call	288
Siemens Series 600 (12" to 36" Belt Width) Weighfeeder	Call	288
Siemens Series 800 (18" to 42" Belt Width) Weighfeeder	Call	288
Siemens Series 1200 (18" to 72" Belt Width) Weighfeeder	Call	288
Siemens VG Volumetric Control Gate	Call	288

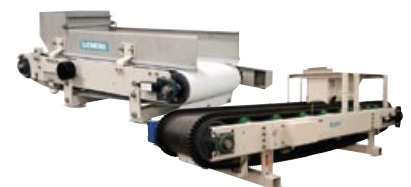

Bulk Solids Flow System Accessories		
Siemens MD-256 Digital Speed Sensor	\$857.00	287
Siemens SITRANS WS100 Speed Sensor	\$575.00	287
Siemens RBSS Return Belt Speed Sensor	\$718.00	287
Siemens MWL Mechanical Calibration Weight Lifter	\$1250.00	287
Siemens BW100 Integrator for Belt Scales	\$1738.00	289
Siemens BW500 Integrator for Belt Scales and Weighfeeders	\$2800.00	289
Siemens SF500 Integrator for Bulk Solids Flowmeters	\$2800.00	289



Prices in this catalog are current at the publication date, and are subject to change without notice. Due to manufacturer agreements, some products may not be available in all Lesman markets or geographic areas.

Acoustic Sensor and Controller for Bulk Solids Flow

SIEMENS

Features

- **Non-Mechanical:** Won't foul up or wear out
- **Noninvasive:** Won't break, leak, or clog
- **Simple Mounting:** Won't take long or require shutdown
- **Acoustic Emission Detection Technology:** Reliably detects material flow/no flow conditions
- **Two Alarm/Control Relays and 0/4-20 mA Output:** Will easily connect to your process

Reliable, Continuous Protection for Bulk Solids Flow

The SITRANS AS100 sensor prevents problems in solids flow processes caused by abnormal flow, sudden blockages, product absence, or equipment failure, such as burst filter bags. It reacts instantly to changes in flow of pellets, powders, or most bulk solids in pipes, chutes, vibratory feeders, pneumatic conveyors, and gravity flow systems.

Any sudden blockage that prevents product flow or any rupture that increases flow as product escapes from a pipe or bag is immediately detected by the AS100. This enables you to take early preventative action, avoiding expensive damage.

Early Warning of Flow Problems

The friction and impact of bulk solids flow in pipes, chutes, and conveyors all generate high frequency sound waves — noises that are often inaudible to the human ear. The SITRANS AS100 detects deviations in these sound waves caused by changes in solids flow rates and warns of impending problems.

Operation Unaffected by Plant Environment Noise

The AS100 uses unique acoustic emission technology to detect high frequency sound waves generated by equipment and materials in motion. These sound waves travel readily through solids materials, but are strongly attenuated when traveling through air. Consequently, the AS100 is immune to interference from airborne noise and low level structural vibration, providing a noninvasive method of process monitoring. Because the AS100 operates in a high frequency broadband, it is immune to competing background noise generated by machines and other processes. Audible noises and low frequency vibrations are screened out.

Simple, Low-Cost Installation

The noninvasive sensor can be installed without any shutdown of process or equipment. In minutes, the compact unit can be attached to a flat surface, pipe, flange, elbow, or joint, where acoustic emission levels are potentially highest.

The light-weight unit weighs only one pound and is easily positioned. A range of installation options are available to suit your needs. Installation can be via a clearance hole and bolt, drilling and tapping, mounting disc, or an extension tab. The unit can be screwed in, bolted in, or bonded in place. Once installed, simply connect the power supply and alarm output and set the alarm level, and the unit is fully operational.

24-Hour Protection in Tough Environments

With no moving parts and a type 304 stainless steel housing sealed against dust and moisture, the AS100 provides continuous protection around the clock and requires little or no maintenance.

Because the AS100 is mounted outside the process, it is completely noninvasive. In hazardous or hygienic food environments, this is a great advantage as there is no need for constant cleaning and concerns about product contamination are eliminated. The SITRANS AS100 is also unaffected by abrasive applications.



The standard sensor operates effectively from -4° to 176° F (-20° to 80° C), with extended temperature options offering sensing from -40° to 185° F (-40° to 85° C) or -40° to 257° F (-40° to 125° C).

Field-Proven Detection

The SITRANS AS100 monitors a wide range of granular and bulk solids materials, including:

- Sugar (granulated or powder)
- Coal (slugs to dust)
- Polyethylene pellets
- Cocoa beans
- Fiberglass
- Wood chips
- Cement
- Grain
- Sand

Applications include:

- Solids flow sensing
- Flow/no flow, high flow/low flow
- Inflow blockage detection
- Cyclone blockage detection
- Filter monitoring and switching
- Burst filter bag detection
- Route verification

Ease of Use

The AS100 system combines a highly sensitive acoustic sensor with easily set up controls. Powered by 20 or 30 VDC, the sensor provides a DC analog voltage that can be monitored by the dedicated SITRANS CU 02 control unit, or a PLC that accepts 0-10 VDC input signals.

Control Options

With a SITRANS CU 02 control unit, the system can be readily configured for setpoints indicating such conditions as high flow, low flow, or no flow, or it can be added to a control loop via a 4-20 mA output.

Two relays are fully programmable and independent of each other, and can be used to operate an alarm or switch device. The control unit can be mounted up to 1500 feet from the sensor.

The signals are amplified and processed by the AS100 sensor to provide the levels of acoustic emission activity as a function of time.

With a CU 02 as part of the system, two relays, an LCD, and 4-20 mA outputs are provided. The sensor output can also be fed directly to a PLC accepting a 0-10 VDC signal.

The sensor can also be operated independently of the control unit by providing an external power supply.

The output is fed into a control panel, chart recorder, data logger, or programmable logic controller with a suitable input.

Dimensions

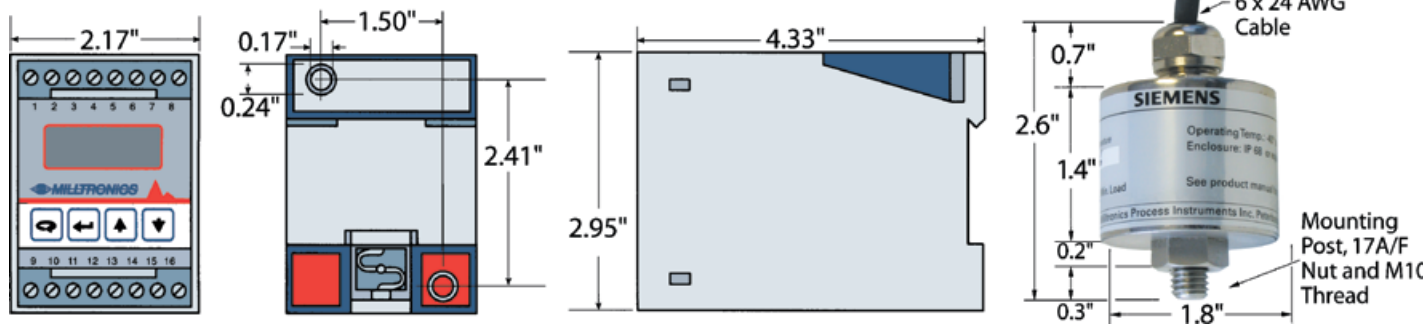

**Acoustic Emission Technology:
 How It Works**

The AS100 sensor uses acoustic emission technology, which is a completely noninvasive technique. The sensor monitors high frequency sounds or structure-borne acoustics generated by friction and impact of powders, granules, and solids in motion. Monitoring this activity provides the basis for the sensor's exceptional troubleshooting capabilities, which are further extended by its dual range of operation.



Process and operating equipment naturally generate sounds that can span a wide range of frequencies. Low frequency sounds — whether airborne or structure borne — are often masked by irrelevant sounds from adjacent plant or machinery. This can prevent the activity of interest from being monitored. However, at the high frequencies of acoustic emission, these problems can be greatly diminished.

The AS100 is most responsive to the diffuse-field component of the acoustic emission activity: it senses the acoustic sound wave's reverberation as it propagates through the component being monitored. As a result, positioning and orientation of the sensor are not critical, as signals are readily detected at all points and orientations for a particular application. By detecting acoustic emission activity, the sensor differentiates between normal and abnormal states in a given process.

A sensitive piezo-crystal inside the AS100 sensor converts surface displacements of the structure associated with the traveling acoustic wave. It converts them into an electric signal that is amplified and processed to produce the level of acoustic emission activity as a process of time.

**Great for plugged chute detection!
 Works well in filter monitoring and
 burst filter bag detection applications!**

Specifications

Sensor

- Power:** 20 to 30 VDC, 18 mA typical
- Relative Sensitivity:** 0.5%/°C average, over the operating range
- Output:** Analog, 0.08 to 10 VDC nominal, 100 KΩ min. load impedance
- Cable:** *Standard:* 13'; PVC jacket, 3 twisted pairs, 24 AWG, shielded; *Extended:* 13'; thermoplastic elastomer jacket, 6 conductor, 24 AWG, shielded
- Housing:** 304 stainless steel; **Ingress Protection:** IP68 (waterproof)

Control Unit

- Power:** 100, 115, 200, 230 VAC ±15% 50/60 Hz (factory set); **Excitation:** 26 VDC nominal, 70 mA max; **Consumption:** 10 VA max
- Analog Input:** 0-10 VDC, from sensor
- Analog Output:** 4-20 mA, isolated output, 750Ω max; **Switched:** Two Form C relays, latching or nonlatching 5 Amp at 250 VAC non-inductive
- Alarm and Startup Delay:** Adjustable from 0 to 999 seconds
- Operating Temperature:** -4° to 122° F ambient
- Housing:** Polycarbonate; **Ingress Protection:** IP20
- Wall Mount Display:** LCD, 3 digits plus symbols

Ordering Instructions

Pick one control unit, and then select your sensor configuration by choosing one option from each table section below. A complete catalog number looks like this: 7MH7562-2AA and 7MH7560 - _____

Issue all orders to: Siemens Industry Inc, c/o Lesman Instrument Company

Model Selection Guide

Description		Catalog Number	Price
SITRANS CU-02 Control Unit, 115 V Power		7MH7562-2AA	\$513.00
SITRANS CU-02 Control Unit, 230 V Power		7MH7562-4AA	513.00
SITRANS AS100 Acoustic Sensor		7MH7560-	757.00
Sensor	Standard (-4° to 176°F) (Note 1)	1A ___ -	0.00
	Extended (-40° to 257°F) (Note 2)	3A ___ -	250.00
	Extended (-22° to 248°F) (Note 3)	4A ___ -	250.00
Mounting	None	__ A0 __ -	0.00
	Mounting Disk	__ B0 __ -	65.00
	Extension Mounting Tab	__ C0 __ -	65.00
Approvals	CE	___ 1	0.00
	CE, FM/CSA Class II, Div 1, Grps E-G	___ 3	131.00
	CE, CSA Class II, Div 1, Grps E-G	___ 4	131.00
Accessories	Mounting Tab	7MH7723-1AA	64.00
	Mounting Disk	7MH7723-1AB	64.00
	1/2" NPT Adapter Kit (Sensor 1)	7MH7723-1BW	170.00
	1/2" NPT Adapter Kit (Sensor 3)	7MH7723-1BX	170.00
	AS100 English Manual	7ML1998-5DM01	8.00
	CU-02 English Manual	7ML1998-5DN01	6.00

Note 1: Not available with FM approval (Approval 3)
 Note 2: Available only with CE approval (Approval 1)
 Note 3: Available only with CE/CSA approval (Approval 4)

Motion Failure Alarms



Rugged motion sensors protect your equipment — reduce downtime and costly repairs

Search www.lesman.com for MFA 4p

Composed of powerful, extremely sensitive probes and innovative electronics, these systems assure reliable alarm indication for monitoring loss of motion in any conveying and rotating machinery.

Not only are the rugged probes impervious to dust, dirt build-up, and moisture, but their noncontacting design eliminates the need for lubricating, cleaning, and replacing of parts. Indoors and outdoors, year after year, Siemens' motion sensing systems operate maintenance-free.

All Siemens motion sensors are easy to install. Gap distance between the sensed ferrous object and the probe can be as much as 4". Wiring costs are minimal, because the probes can use the same conduit, or armored cable, as the drive motor and its control circuits.

Motion sensor systems greatly reduce the downtime and cleanup expenses associated with failure of conveying equipment. Spillage is minimized with the immediate shutdown of pre-feeding equipment. Motion sensor use prevents extensive damage — even fire — due to heat build-up caused by belt slippage at the head pulley, or by a broken belt on a multiple V belt drive. They are so effective in operation that they provide rapid payback of initial cost, often the first time they warn of conveyor malfunction.

Motion Failure Alarm MFA-4p

The general purpose MFA-4p monitors motion and provides the contacts to shut down machinery when plant equipment slows down or fails. On belt, drag, and screw conveyors; on bucket elevators, fans and pumps, the MFA-4p underspeed alarm warns instantly of equipment malfunction. This single setpoint system is ideal for use in most industrial applications, operating reliably where nothing else can.

Visit our website for more information on Siemens motion failure alarms and speed sensors.

www.Lesman.com



Probes for Siemens MFA-4*

Standard MSP-12

- Temperature rating -40° to 140°F
- #1 Seller! Withstands most environments
- Long-lasting phenolic body, internal preamp
- Mounting flange and locknut for fast installation and setup



High Temp MSP-3

- Temperature rating -40° to 140°F
- Withstands temperatures to 500°F
- Cast aluminum probe with mounting flange
- (1.5m) 5 ft. high-temperature cable provided, up to 100 ft. max length
- Preamp remote mounted in cast aluminum NEMA 4 enclosure



Harsh Environment XPP-5

- Temperature rating -40° to 140°F
- CSA hazardous approval (Class 1, Div 1, Groups A-D, Class II, Div 1, Groups E-G, Class III)
- Cast aluminum probe with mounting flange and lock nut
- (1.5m) 5 ft. high-temperature PTFE cable provided, up to 100 ft. max length
- Preamp remote mounted in cast aluminum NEMA 4 enclosure



Mini-Probe MSP-1

- Temperature rating -60° to 180°F
- CPVC probe body with locknuts
- Probe sensitivity gap max. 0.5"
- Preamp remote mounts in cast aluminum NEMA 4 enclosure
- 6 ft. cable included, up to 100 ft. can be used



Stainless High Temperature MSP-9

- Operates in environments to 500°F
- 304 stainless steel probe
- 5 ft. special high-temp Teflon cable provided, up to 100 ft. max length
- Preamp remote mounted in enamel painted (or stainless steel) enclosure



Remote mount amplifier for MSP-1, MSP-3, and MSP-9 motion sensing probes. Available in aluminum, painted steel, or NEMA 4X stainless steel enclosures.



Pressure Transmitters

Anderson Greenwood Instrument Valves

Level Measurement Instruments

Flow Measurement Instruments

Solids Flow and Motion

Actuator Motors and Pneumatic Drives

SIEMENS

Specifications

Span: 0–7200 PPM; *Setpoint Adjustment:* 2–3000 PPM; Adjustable start-up time delay

Ambient Temperature: -40° to 140°F; *Repeatability:* ±1%; *Deadband:* ±1/4%

Power: 110/115/200/230 VAC 50/60 Hz, Switch Selectable

Output: Two Form C relay contacts (DPDT) rated 10A 115/230 VAC resistive, or 10A 24 VDC resistive

Visual Indication: For probe operation and relay status

Cable to Pre-Amp: 2 wires #18 to 12AWG pulled in conduit with the 115 VAC motor control wiring, or armored cable

Enclosure: Corrosion-proof NEMA 4 polycarbonate

Options: Open frame style (with or without brackets); Overspeed alarm; 230VAC +10% 50/60 Hz at 5VA; *Slow Speed Available in the U.S.:* 1 pulse/10 min. minimum; 1 pulse/3 sec. maximum

Ordering Instructions

Select one option from each table section below. A complete MFA-4p catalog number looks like this: 7MH7144-____. A complete system includes a probe, remote mount amplifier (as needed), and mounting hardware.

Model Selection Guide

*Issue all orders to: Siemens Industry Inc,
c/o Lesman Instrument Company*

Description		Catalog Number	Price
MFA-4p Motion Failure Alarm Electronics Unit		7MH7144-	\$352.00
Enclosure	NEMA 4X Polycarbonate	1A __	0.00
	NEMA 4 Painted Mild Steel	2A __	417.00
	NEMA 4X Stainless Steel	3A __	835.00
Speed Detection Version, Switch-Selectable			
Speed	Standard/Underspeed/Overspeed	__ A _	0.00
	Slow/Underspeed/Overspeed	__ B _	129.00
Approvals	CE, CSAUs/C, FM	__ 2	0.00
MFA-4p Spare Parts and Accessories			
Spare MFA 4p Relay		7MH77231DW	14.00
Spare MFA 4p Transformer		7MH77231DX	37.00
Spare MFA 4p Circuit Card, Standard		7MH77231DU	267.00
Spare MFA 4p Circuit Card, Slow Speed		7MH77231DV	345.00
Instruction Manual (Note 3)		7ML1998-5FM01	6.00
Probe Selection	MSP-1 (Note 1)	7MH7146-0AA	201.00
	MSP-3, 1/2" Conduit Entry (Note 1)	7MH7146-0BA	326.00
	MSP-9 (Note 1)	7MH7146-0DA	693.00
	MSP-12, 1/2" Conduit Entry	7MH7146-0EA	294.00
	XPP-5, 1.5m Cable (Note 2)	7MH7146-0GA	564.00
Remote Amplifier (Note 1)	Aluminum, 1/2" NPT Entry	7MH7145-0A	206.00
	Painted Steel, NEMA 4	7MH7145-0C	379.00
	Stainless Steel, NEMA 4X	7MH7145-0D	1015.00
Probe and Remote Mount Amplifier Spare Parts and Accessories			
Spare Remote Mount Amplifier Card		7MH77231DT	103.00
MSP-1 Locknut		7MH77231CQ	16.00
MSP-3, MSP-9 Lid Gasket		7MH77231CW	11.00
MSP-3, MSP-12, XPP-5 Locknut		7MH77231CR	11.00
MSP-3, MSP-12, XPP-5 Mounting Flange		7MH77231CS	21.00
MSP-3, MSP-12 Lid with 1/2" NPT Conduit Entry		7MH77231CU	21.00
MSP-9 Mounting Bracket		7MH77231CT	125.00
MSP-9 Lid		7MH77231CV	41.00
MSP-12 Lid Gasket		7MH77231CX	11.00

Notes:

- 1 Remote amplifier required for MSP-1, MSP-3, and MSP-9 models.
- 2 XPP-5 has CSA approval, Class I, Groups A–D, Class II, Groups E–G.
- 3 One instruction manual covers the MFA-4p electronics unit, all the probes, and the RMA remote amplifier unit.

Zero Speed Switch



Noncontacting, self-contained, easy-to-install

The Siemens Zero Speed Switch (ZSS), self-contained device provides a set of dry relay contacts for indication of motion or lack of motion in rotating, reciprocating, and conveying equipment. The ZSS features built-in start delays that allow the monitored equipment to accelerate to normal operating speed before monitoring begins.

Siemens ZSS can be used to monitor a piece of equipment directly, or indirectly through a PLC. When the moving portion of the equipment slows down or stops suddenly, the ZSS detects the change and operates a contact. If unit operation is tied directly to the motor control center, the action stops the motor and any associated equipment. If tied to a PLC, control action depends on the PLC's program.

Like all Siemens motion sensors, the Zero Speed Switch probe is easy to install. To sense motion, the probe must be mounted in proximity to a ferromagnetic target on the equipment. Probe target distance is nominally 1" for optimum operation, with a maximum of 2". Wiring costs are minimal because the ZSS can use the same conduit, or armored cable, as the drive motor and its control circuits.

Specifications

Output: One Form C relay contact (SPDT), 115/230 VAC, 3A, 150W resistive

Dropout Timing: 10 ±1 second (6ppm); terminal block selected to 5 seconds (12 ppm)

Input: 115/220 ±15% VAC (50/60 Hz, 2 VA)

Operating Temperature: -40° to 140°F (-40° to 60°C)

Gap Distance: 1" nominal, 2" max.

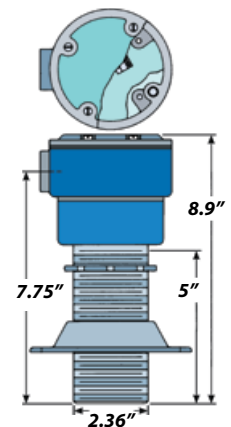

Model Selection Guide

*Issue all orders to: Siemens Industry Inc,
c/o Lesman Instrument Company*

Description		Catalog Number	Price
ZSS Motion Sensing Switch, Heavy-Duty Zero Speed Alarm. Does not require a separate controller.			
Zero Speed Switch, 115 VAC Powered		PBD-92712000	\$469.00
Zero Speed Switch, 230 VAC Powered		PBD-92722000	528.00
Accessories	Spare Locknut	7MH77231CR	11.00
	Spare Mounting Flange	7MH77231CS	21.00
	ZSS Instruction Manual	7ML1998-5DF01	3.00

Belt Scale Selection Guide

A typical belt scale system consists of the belt scale, an integrator, and a speed sensor, like the system shown here. Your application requirements will dictate the proper system combination.



SIEMENS



Belt scales help maximize the use of raw materials, control inventories, and aid in the manufacturing of a consistent product. Siemens belt scale combine simple, drop-in installation, low maintenance (no moving parts), and repeatable accuracy for productive operation. They show minimal hysteresis, and superior linearity, and ignore side loading. All belt scales shown here feature overload protection for the load cells. When used with approved intrinsic safety barriers, MLC, MCS, MSI, and MMI belt scales can be used in hazardous locations.

Model	Low Capacity (MLC)	New! Modular Basic (MBS)	Medium Duty (MUS)	New! Compact (MCS)	Single Idler (MSI)	Multiple Idler (MMI)
Description	Low capacity scale for light belt loading	Modular, basic, medium duty belt scale providing dynamic weighing data for process indication	Modular, medium-to-heavy duty scale for process indication	Compact, rugged, modular belt scale with stainless steel load cells	Heavy duty, high accuracy single idler scale for process and load-out control	Heavy duty, high accuracy multiple idler scale for critical process and load-out control
Capacity (Max)	50 t/h (55 STPH)	1500 t/h (1650 STPH) at max belt speed	5000 t/h (5500 STPH) at max belt speed	Up to 1200 t/h (1320 STPH) at max belt speed	5000 t/h (5500 STPH) at max belt speed	Up to 12000 t/h (13000 STPH)
Belt Speed (Max)	2.0 m/s (400 fpm)	3.0 m/s (600 fpm)			4.0 m/s (800 fpm)	
Particle Size	<25 mm (1") max.	<100 mm (4") max.		<150 mm (6") max.		
Belt Width (Nominal)	450 to 1200 mm (18" to 48")	Fits most conveyor widths to 1000 mm (42" CEMA)	Fits most conveyor widths, standard duty ≤1000 mm (42"), heavy duty ≥1200 mm (48")	Up to 1000 mm (42" CEMA)	500 to 2000 mm in metric sizes (18" to 96" CEMA). Other sizes available on request.	450 to 2400 mm (18" to 96" CEMA or standard metric conveyors). Others available on request.
Idler Diameter	50 or 60 mm or 1.9"	50 to 150 mm (2" to 6")	50 to 180 mm (2" to 7")	100 to 150 mm (4" to 6")	50 to 180 mm (2" to 7")	
Weighspan (Min)	450 mm (18")	500 mm (20")		600 mm (24")	450 mm (18")	450 mm (18"), two per scale
Accuracy	±1.0% or better	±1.0%	±0.5 to 1.0%	±0.5 to 1.0%, ±2.0 on mobile applications	±0.5% or better	±0.25% or better
Turndown Ratio	5:1	3:1	4:1		5:1	
Materials	Painted mild steel or stainless steel	Painted mild steel, modular design		Painted mild steel, stainless steel load cells	Painted mild steel or stainless steel	Two or more MSI units installed in a series
Load Cells	Two parallelogram-style stainless steel, temperature compensated	Two parallelogram-style aluminum, temperature compensated	Two parallelogram-style nickel plated alloy steel, temperature compensated	Two stainless steel triple beam parallelogram, temperature compensated, overload protection		
Standard Parts	Weighing idler, full frame structure	Idler ordered separately, dual weigh modules		Idler ordered separately, dual weigh modules, test weigh bracket, test weight	Idler ordered separately, full frame structure	
Options	Test weight	Test weight mounting brackets, test weights	MWL weight lifter, test weights	—	MWL weight lifter, test weights, test chains	
Approvals	CE				SABS, CE, Measurement Canada	NTEP, CE, Measurement Canada
Learn More	Visit our website at www.Lesman.com/unleashhd or fill out the application datasheet at www.Lesman.com/datasheets and fax it to Lesman for an engineering review.					

Pressure Transmitters

Anderson Greenwood Instrument Valves

Level Measurement Instruments

Flow Measurement Instruments

Solids Flow and Motion



Actuator Motors and Pneumatic Drives

Bulk Solids System Components



Speed Sensors for Siemens Belt Scale Systems

Speed sensors operate in conjunction with a conveyor belt scale, providing a signal to an integrator for calculation of belt speed, flow rate, and totalized weight.

Model	 Milltronics RBSS	 Milltronics MD-256	 SITRANS WS100
Description	High resolution, wheel-driven return belt speed sensor	High resolution, shaft-driven speed sensor	Compact, medium resolution, pulley shaft-driven belt speed sensor with magnetic mount
Function	Provides a signal generated as the wheel on the sensor rotates on the return belt; Accurate belt speed detection	Converts shaft rotation into a pulse train of 256 pulses per revolution; Bidirectional for clockwise and counterclockwise shaft rotation; Suitable for low or varying shaft speeds	Converts shaft rotation into a pulse train of eight pulses per revolution; Can be used to monitor rotational speed when directly connected to a PLC
Construction	IP65 rated rugged design, CE approval	IP65 NEMA 4X rated, CE approval	NEMA 4/IP65; IS version available

See page 289 for full details on Siemens Milltronics integrators for belt scales, weighfeeders, and bulk solids flowmeters.

Milltronics MWL Weight Lifter for Siemens Belt Scales

- Can be used with new and existing applications
- Safe and easy application of belt scale reference weights, with the operator remaining outside the conveyor
- Easy-to-store drive handle that can be applied to left or right side of MWL
- Low profile fits easily into belt conveyor
- Security pin ensures safe weight storage



Milltronics MWL Weight Lifter is a mechanical calibration weight lifter for MSI, MMI, MBS, MCS, and MUS belt scales.

Milltronics MWL mechanically raises and lowers the static weights and then stores the weights securely above the belt scale calibration arms, and allows the operator to lower and apply them safely without having to lean into the conveyor.

The MWL is manually operated, and uses a high mechanical advantage to enable weights up to 750 lbs to be applied with limited effort. The crank handle uses twelve rotations for full range of motion, and can be removed and stored for safety with the locking ball-pin that secures the MWL when it is not in use.

Two lifting arms support a base-bar weight above the test-weight brackets of the belt scale: either flat bar or round bar style calibration weights are applicable. Locating notches in the base-bar weight engage the calibration weights securely on the lifting arms in the stored position, and the gear drive locks the lifting arms in place.

Specifications

Application: Span calibrations on belt conveyors

Components: Left-handed or right-handed crank body, each connected to a lifting pad with guide pin; Torque tube to connect left and right crank shafts; Crank handle that mounts to either the left or right input shaft; U-clamp to secure flat bar calibration weights; Optional base bar with integrated round bar weight or to support other types of calibration weights; Optional shaft extension adds 4" (102mm) to handle shaft length

Crank Arm: Mechanical advantage 20:1, 12 revolutions required for raising or lowering

Approvals: Compliant with Directive 98/37/IEC, CE, C-TICK

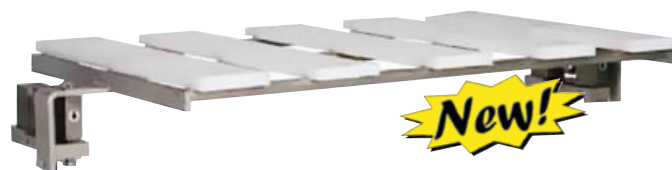

WD600 Slider Bed Belt Scale

- Unique weighing mechanism design with low friction and long weigh area for increased retention time, resulting in higher accuracy and reliability
- Ultra-sensitive parallelogram style load cells (nickel-plated alloy or stainless steel) provide precision weighing accuracy
- Drop-in weighbridge for quick washdown and maintenance

Milltronics WD600 is a light- to medium-duty slider bed belt scale used for process and load-out control in manufacturing. Its corrosion resistant WD600 components are durable and virtually maintenance-free.

WD600 works with an existing flat belt conveyor and a Siemens integrator. As material is moving along the conveyor belt and travels over the belt scale, it exerts a force proportional to the material load through the suspended weighbridge to the load cells. WD600 reacts only to the vertical component of the applied force.

Specifications

Typical Applications: Monitor feed rates and blending in cereals, seeds, minerals, wet foods, or powder additives into a process

Measuring Principle: Heavy duty strain gauge load cells measuring load on a belt conveyor

Temperature: Material: 150°F (65°C) max.; Operating range: -40° to 150°F (-40° to 65°C); Compensated range: 15° to 105°F (-10° to 40°C)

Capacity: Up to 18 t/h; Nickel-plated load cells: 10, 15, 20, 30 kg; Stainless steel load cells: 6 kg, 25, 50 lbs; Overload: 150% of rated load cell capacity

Belt Width: 12", 18", 24", 30", 36" or 48" (300 to 1200 mm)

Accuracy: ±0.5% to 1% totalization over 4:1 operating range, application dependant

Construction: Stainless steel with UHMW slider pads, nickel-plated alloy steel or stainless steel load cells.

Output: Two mV/V or three mV/V, depending on load cell version; Non-repeatability: 0.01% of rated output; Non-linearity: 0.02% of rated output

Compatible with: Milltronics BW100 and BW500 integrators, or SIWAREX FTC weighing module (for integration directly into PLC system)

Weighfeeder Selection Guide



Ultra-sensitive load cells provide precision weighing accuracy, improving blend consistencies, accountability, and record-keeping. Weighfeeders are indispensable when automated production processes require continuous in-line weighing and feeding. Depend on these heavy duty weighfeeders to deliver fast, reliable, and uninterrupted service. The virtually maintenance-free construction promises unmatched performance.

Milltronics weighfeeders come standard with belt weigh bridge and speed sensor. Flanged belting is available on all models. Belt sizes and widths are made to measure for your specific application. Complete your weighfeeder system with a Milltronics integrator.

Model	Series 400	Series 600	Series 800	Series 1200	VG Volumetric Control Gate
Description	High accuracy, low capacity for minor ingredient additives	Low to medium capacity for minor ingredient additives	Medium to high capacity for macro ingredient additives	Heavy duty high capacity for macro ingredient additives	For rate control in blending, batching, or loading operations
Typical Applications	Control and monitor feed rates and blending for extruders in pet foods, breakfast cereals or snack foods; Fruits and nuts for processing or packaging; Cereals, seeds, or minerals; Pebble lime into a slaker in water treatment; Pigments added to plastic pellets	Control and monitor feed rates and blending for wet food processing, extruders in pet foods, breakfast cereals, or snack foods; Minerals or powdered additives; Fruits, seeds, and grains, fertilizers, and salt	Industrial and process applications (feeding, blending, or rationing) in cement, gypsum, wallboard manufacturing, fertilizer plants; dried pet foods; direct reduction iron processing or hot briquetted iron facilities	Industrial and process applications (feeding, blending, or rationing) in cement, gypsum, wallboard manufacturing, fertilizer plants; direct reduction iron processing or hot briquetted iron facilities	Blending control of fractionated stone from 8 mesh to 4"; blending control of grains; side gates for load-out bins; eliminates vibratory feeders
Capacity	100 lbs/hr to 20,000 lbs/hr	1000 lbs/hr to 20 TPH	5 to 80 TPH	10 to 300 TPH	600 to 1750 TPH
Belt Width	9" to 12"	12" to 36"	18" to 42"	18" to 72"	Gate sizes: 12"x16", 16"x22", 20"x28"
Inlet to Discharge	33"	52"	62"	93"	—
Motor Size	0.25 HP	0.33 HP or larger	0.5 HP or larger	1 HP or larger	0.75 HP
Belt Speed	1 to 40 FPM			10 to 70 FPM	—
Pully Diameter	4"	6"	8"	12" and up	—
Accuracy	±0.25% to 0.5%			±0.5%	
Turndown Ratio	10:1 load-based, Up to 30:1 speed-based				10:1 volumetrically
Sensing Element	Platform weighbridge, single load cell	Platform weighbridge, dual load cell	Single idler, dual load cell	Dual idler, torque tube	Flow detector, paddle or acoustic flow sensor
Construction	Mild steel or stainless steel		Mild steel		Hot dipped galvanized 7-gauge plate steel
Flanged Wall Size	1" max.	2" max.		3" max.	
Duty	Light	Light to medium	Medium industrial	Heavy	Precision control
Features	Belts for specific applications, sanitary version available	Custom units for special application needs, belts for specific applications	Cantilevered frame for quick belt removal, inlet configurations, stainless steel contact parts	Cantilevered frame for quick belt removal, inlet configurations	Custom gate sizes available, limit switch, position sensor
Approvals	CE, Meets USDA and FDA requirements for food processing			CE	
Learn more	Visit our website at www.Lesman.com/unleashd or fill out the application datasheet at www.Lesman.com/datasheets and fax it to Lesman for an engineering review.				

Pressure Transmitters

Anderson Greenwood Instrument Valves

Level Measurement Instruments

Flow Measurement Instruments

Solids Flow and Motion

Actuator Motors and Pneumatic Drives

Electronic Integrators for Bulk Solids Flow Systems

A typical weighfeeder system consists of the weighbelt feeder and an integrator, like the system shown here. Your application requirements will dictate the proper system combination.

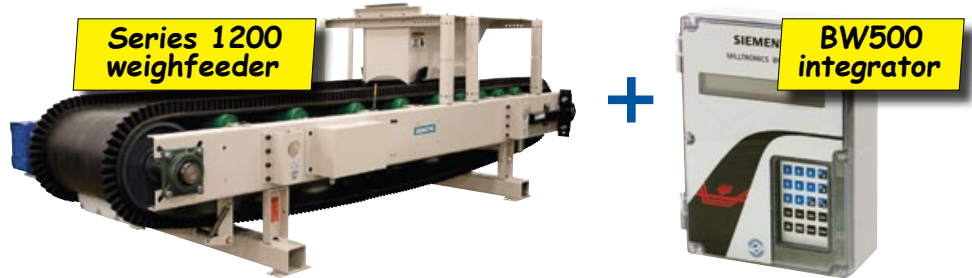



Integrators for Belt Scales, Weighfeeders, and Solids Flowmeters

Electronic integrators process sensor signals into operating data for continuous in-line weighing and flow measurement. They can perform basic control functions, like PID and batch control, traditionally handled by higher level devices. Easy to install, commission, operate, and maintain, Milltronics integrators from Siemens incorporate patented electronic load cell balancing to perform basic and sophisticated level and flow control functions.

Siemens Dolphin Plus software can be used for quick and easy configuration. SmartLink modules — available for Allen-Bradley remote I/O, Profibus DP, and DeviceNet — can provide direct digital communications with your plant control system.

Learn more about Dolphin Plus and SmartLinx on pages 228 and 229.

Model	 For belt scales Milltronics BW100	 For belt scales and weighfeeders Milltronics BW500	 For bulk solids flowmeters Milltronics SF500
Description	Economical integrator for use with belt scales	Full feature integrator for use with belt scales and weighfeeders	Full feature integrator for use with solids flowmeters
Compatibility	MCS, MBS, MLC, MUS, and MSI belt scales, Retrofit with other installed belt scale systems (two load cells max)	MLC, MBS, MUS, MSI, MMI, and MCS belt scales, 400, 600, 800, and 1200 series weighfeeders, Retrofit most other belt scales or weighfeeders	E, A, V series flowmeters, Other one or two load cell flowmeters, LVDT-equipped solids flowmeters (using optional interface board)
Display	1.5" x 4" graphic LCD Displays rate, totalized weight, belt loading, and belt speed	0.56" x 6" dual line 40-character backlit dot matrix LCD; Displays rate, totalized weight, belt loading, belt speed, PID, batching, errors, and diagnostics	0.56" x 6" dual line 40-character backlit dot matrix LCD; Displays rate, totalized weight, PID, batching, errors, and diagnostics
Analog Output	Optically isolated 4-20 mA, scalable Selectable for rate, load, or speed	Optically isolated 4-20 mA, scalable Option: Two additional analog inputs and two outputs programmable for PID control	
Remote Totalizer	Two adjustable pulsed outputs		
Alarm Relay	One programmable Form C SPDT contact relay, rated 5A @ 230 VAC, non-inductive	Five programmable Form A SPST contact relays, rated 5A @ 250 VAC non-inductive, reversible	
Enclosure	Type 4X, NEMA 4X, IP65 PVDF enclosure	Type 4X, NEMA 4X, IP65 polycarbonate enclosure	
Temperature	-4° to 122°F (-20° to 50°C) ambient		
Power	100/115/200/230 VAC ±15%, 50/60 Hz, 15VA Optional 12 VDC and 24 VDC	100/115/200/230 VAC ±15%, 50/60 Hz, 31VA	
Communications	Bi-polar serial current loop Dolphin Plus interface configuration software	Two RS-232 ports, one RS-485 port, Modbus RTU/ASCII; Optional SmartLinx® communications modules: A-B RIO, Profibus DP, DeviceNet; Dolphin Plus interface configuration software	
Features	Non-volatile memory safeguards against data loss; Choice of alarms (rate, total, speed); Multipoint linearization function; Errors and diagnostics display; Multi-field display	Battery-backed memory; Multiple alarms (rate, load, speed); Step-by-step programming; Optional I/O cards for PID control, moisture sensor input, or incline meter input; Multipoint linearization function; Automatic zero; Electronic span calibration available; Up to eight multispan for applications of more than one feed condition or material; Differential speed detection	Battery-backed memory; Alarms for rate or diagnostic error; Step-by-step programming; Optional I/O cards for dual PID control or moisture sensor input; Multipoint linearization function; Automatic zero; Electronic span calibration available; Up to eight multispan for applications of more than one feed condition or material
Approvals	CSA, FM, CE	CSA, FM, CE, NTEP, Measurement Canada	CSA, FM, CE

For more complete information, please visit our website at www.Lesman.com

Pressure Transmitters
 Anderson Greenwood Instrument Valves
 Level Measurement Instruments
 Flow Measurement Instruments
 Solids Flow and Motion
 Actuator Motors and Pneumatic Drives

Choosing the Right Solids Flowmeter

SIEMENS

A typical solids flowmeter system consists of the flowmeter, sensing head, and an integrator, like the system shown here. Your application requirements will dictate the proper system combination.



Solids flowmeters enhance process control, contributing to improved quality of your end product and a positive bottom line. These heavy duty, low maintenance solids flowmeters provide continuous in-line weighing of dry bulk solids, free-flowing powders, or granular material. All models produce accurate, repeatable results, and can be used for critical functions like batch load-out and blending. All models are totally enclosed and dust-tight, and are constructed of painted mild steel. Stainless steel and hazardous area classification models are also available.

Model	Milltronics E Series	Milltronics V Series	Milltronics A Series
Description	Low to medium capacity flowmeter for various product sizes, densities, and fluidity, particularly fine powders	Compact, vertical flow, low to medium capacity flowmeter for various product sizes, densities, and fluidity, particularly fine powders	Low to medium capacity flowmeter for powders conveyed by aerated gravity conveyors
Typical Applications	Fly ash, lime dosing in gold ore processing, adding sugar in food manufacturing, gypsum flow for board forming line	Applications with little headroom	Cement flow in aerated gravity conveyor systems
Inlet Sizes	E-40: 2" to 10" (50 to 250 mm) E-300: 6" to 16" (150 to 400mm) in ASME or DIN flanges	V-40: 3"x6", 4"x10", or 5"x12" (76x152 mm, 102x254mm, or 127x305mm) V-300: 5"x16" or 6"x20" (127x406mm or 152x508mm)	A-40: 8" or 23" (203 or 305mm) A-300: 10", 14", or 20" (254mm, 356mm, or 508mm)
Capacity Range	0.2 to 40 t/h (0.2 to 44 STPH) or 20 to 300 t/h (22 to 330 STPH), depending on model		
Particle Size	0.5" (13 mm) or 1.0" (25 mm), depending on model		
Product Temperature	450°F (232°C) standard, 750°F (400°C) optional		
Accuracy	±1% of design rate		
Turndown	3:1		
Sensing Plate	304 stainless steel standard, 316 stainless steel optional, E and V series available with mirrored finish		
Coatings	Plasma A/R, polyurethane, PTFE, or Alumina ceramic		
Sensing Heads	Compatible with ILE-37 (0.5" max particle size) or ILE-61 (1" max particle size)		
Sensing Element	Linear variable differential transformer (LVDT) external to process		
Approvals	CE standard; Optional CSA Class I, Group C-D, Class II, Group E-G		
Learn More	Visit our website at www.Lesman.com/unleashd or fill out the application datasheet at www.Lesman.com/datasheets and fax it to Lesman for an engineering review.		

Pressure Transmitters

Anderson Greenwood Instrument Valves

Level Measurement Instruments

Flow Measurement Instruments

Solids Flow and Motion

Actuator Motors and Pneumatic Drives