

## HC900 Hybrid Control Utilities User Guide

Doc. No.: 51-52-25-126  
Revision: 8  
Date: 06/09

# Notices and Trademarks

Copyright 2009 by Honeywell  
Revision 8 June 2009

## WARRANTY/REMEDY

Honeywell warrants goods of its manufacture as being free of defective materials and faulty workmanship. Contact your local sales office for warranty information. If warranted goods are returned to Honeywell during the period of coverage, Honeywell will repair or replace without charge those items it finds defective. The foregoing is Buyer's sole remedy and is **in lieu of all other warranties, expressed or implied, including those of merchantability and fitness for a particular purpose**. Specifications may change without notice. The information we supply is believed to be accurate and reliable as of this printing. However, we assume no responsibility for its use.

While we provide application assistance personally, through our literature and the Honeywell web site, it is up to the customer to determine the suitability of the product in the application.

## Honeywell Process Solutions

512 Virginia Drive  
Fort Washington, PA 19034

HC900 Hybrid Controller is a U.S. trademark of Honeywell

Other brand or product names are trademarks of their respective owners.

# License Agreement

Read this agreement before opening the software. Once you have removed the software from its envelope, you have accepted the agreement.

## **USAGE RIGHTS**

Your rights, with respect to the Software, are non-exclusive. The software may only be used by one user, on one computer at a time. The software may be transferred to another computer, as long as it is only used by one user at a time. The Software and its documentation may not be copied or distributed to others. You may not create, modify, alter, adapt, merge, de-compile or reverse-engineer the Software, and you may not remove or obscure Honeywell or other included copyright or trademark notices.

## **TERM OF LICENSE**

This agreement is effective until terminated. Terminate the Agreement by destroying the Software, documentation and all backup copies.

## **BACKUP COPIES**

You may make backup copies of the Software. The copyright notice(s) must be included on each backup copy.

## **COPYRIGHTS**

The Software accompanying this manual is protected by United States copyright law. The Software documentation is copyrighted. You may only copy the Software and the Software documentation for backup or to load the Software onto your computer as part of program execution.

## **TITLE TO SOFTWARE AND CONFIDENTIALITY**

The Software and all copies thereof are proprietary to Honeywell and title thereto remains in Honeywell. All applicable rights to patents, copyrights, trademarks and trade secrets in the Software are and shall remain in Honeywell.

You may not sell, transfer, publish, or otherwise make available any software copies thereof to others. You acknowledge that the Software is a trade secret of Honeywell. You agree to secure and protect each program, software product and copies thereof in a manner consistent with the maintenance of Honeywell's rights therein and to take appropriate action by instruction or agreement within your organization to satisfy your obligations hereunder. Violation of these provisions shall be a basis for immediate termination of this license. Termination of the license shall be in addition to and not in lieu of any other legal or equitable remedies available in Honeywell.



# About This Document

## Abstract

The **Hybrid Control Utilities** program operates on a PC with Windows 2000, XP or Vista. It lets you view and monitor HC900 Hybrid Controller control strategy configurations and view your Operator Interface menu, screen and button configurations. It uses graphic symbols and line drawing connections to represent control strategies. Completed configurations are loaded into the control system using a dedicated communication port in the controller. Editing of configurations must be done with Hybrid Control Designer software.

## References

The following list identifies all documents that may be sources of reference for material discussed in this publication.

Document Title	Doc ID
HC900 Controller Technical Overview	51-52-03-31
HC900 Controller Installation and User Guide	51-52-25-107
HC900 Operator Interface User Guide	51-52-25-108
HC900 Hybrid Controller Function Block Reference Guide	51-52-25-109
HC900 Hybrid Controller Communications User Guide	51-52-25-111
900 Control Station For use with HC900 Hybrid Controller	51-52-25-148

## Contacts

### World Wide Web

The following lists Honeywell's World Wide Web sites that will be of interest to our customers.

Honeywell Organization	WWW Address (URL)
Corporate	<a href="http://www.honeywell.com">http://www.honeywell.com</a>
Honeywell Process Solutions	<a href="http://hpsweb.honeywell.com">http://hpsweb.honeywell.com</a>
Technical tips	<a href="http://content.honeywell.com/ipc/faq">http://content.honeywell.com/ipc/faq</a>











### Telephone

Contact us by telephone at the numbers listed below.

Organization	Phone Number
United States and Canada	1-800-423-9883
Honeywell	1-800-525-7439
	Tech. Support Service

## Symbol Definitions

The following table lists those symbols that may be used in this document to denote certain conditions.

Symbol	Definition
	This <b>DANGER</b> symbol indicates an imminently hazardous situation, which, if not avoided, <b>will result in death or serious injury</b> .
	This <b>WARNING</b> symbol indicates a potentially hazardous situation, which, if not avoided, <b>could result in death or serious injury</b> .
	This <b>CAUTION</b> symbol may be present on Control Product instrumentation and literature. If present on a product, the user must consult the appropriate part of the accompanying product literature for more information.
	This <b>CAUTION</b> symbol indicates a potentially hazardous situation, which, if not avoided, <b>may result in property damage</b> .
	<b>WARNING</b> <b>PERSONAL INJURY:</b> Risk of electrical shock. This symbol warns the user of a potential shock hazard where HAZARDOUS LIVE voltages greater than 30 Vrms, 42.4 Vpeak, or 60 Vdc may be accessible. <b>Failure to comply with these instructions could result in death or serious injury.</b>
	ATTENTION, Electrostatic Discharge (ESD) hazards. Observe precautions for handling electrostatic sensitive devices
	Protective Earth (PE) terminal. Provided for connection of the protective earth (green or green/yellow) supply system conductor.
	Functional earth terminal. Used for non-safety purposes such as noise immunity improvement. NOTE: This connection shall be bonded to protective earth at the source of supply in accordance with national local electrical code requirements.
	Earth Ground. Functional earth connection. NOTE: This connection shall be bonded to Protective earth at the source of supply in accordance with national and local electrical code requirements.
	Chassis Ground. Identifies a connection to the chassis or frame of the equipment shall be bonded to Protective Earth at the source of supply in accordance with national and local electrical code requirements.

---

## Table of Contents

<b>LICENSE AGREEMENT .....</b>	<b>III</b>
<b>ABOUT THIS DOCUMENT.....</b>	<b>V</b>
Abstract.....	v
References.....	v
Contacts.....	v
Symbol Definitions.....	vi
<b>TABLE OF CONTENTS.....</b>	<b>I</b>
<b>SOFTWARE OVERVIEW AND INTRODUCTION .....</b>	<b>1</b>
Features.....	1
Function Block Configuration development.....	2
Hardware and software requirements.....	3
How To Use This Help.....	4
What to Know Before You Start.....	5
Rack, Module, and Channel Assignments.....	5
<b>IMPLEMENTATION .....</b>	<b>7</b>
Starting the Application.....	7
Connecting the PC to the Controller.....	8
<b>USER INTERFACE.....</b>	<b>9</b>
User Interface Overview.....	9
General Terminology.....	9
File Browser Window.....	11
Worksheet Toolbox Window.....	12
Traceback Window.....	12
Watch Summary Window.....	14
Status Bar.....	15
Menu Conventions.....	15
Selecting a Menu.....	16
Closing a Menu.....	16
Main Menu.....	16
File Menu.....	16
Edit Menu.....	19
View Menu.....	21
Monitor Menu.....	22
Recipes Menu.....	23
Window Menu.....	24
Help Menu.....	24
Main Toolbar Functions.....	24
Navigational Tools.....	26
Right Mouse Click.....	26
Keyboard Navigation.....	27
<b>FILE MANAGEMENT .....</b>	<b>29</b>

---

Opening an Existing File.....	29
Saving A Configuration File.....	29
Creating Other File Types.....	30
Uploading a File from the Controller.....	30
Downloading a File to the Controller.....	31
Download Controller Firmware.....	34
Download Firmware Error Messages.....	36
File Properties.....	37
File Read Protection.....	38
Write Protect a File.....	38
<b>PC COMM PORTS AND CONNECTIONS .....</b>	<b>39</b>
How to Manage PC Comm Ports and Connections.....	39
PC Network Port Set Up For Controller Access.....	39
PC Serial Com Port Setup.....	41
PC to Controller Connection Settings.....	42
Remote Loopback Test.....	43
Remote Access.....	43
Communications Statistics.....	44
<b>WORKSHEETS OVERVIEW .....</b>	<b>47</b>
What is a Worksheet?.....	47
Worksheet Category Tabs.....	48
<b>CONTROLLER WORKSHEET .....</b>	<b>49</b>
Controller Worksheet Overview.....	49
Controller Configuration Toolbar.....	49
E-Mail Notification.....	50
Unlock the Worksheets.....	51
<b>DATA STORAGE.....</b>	<b>53</b>
Data Storage Overview.....	53
Data Storage Conventions.....	53
Data Storage Enable Conditions.....	56
How storage is enabled.....	56
Three Levels of Enabling.....	56
Storage Enable Conditions.....	57
Data Storage Configuration Access.....	60
Create/Edit Data Storage File.....	60
Trend Storage Configuration.....	61
Point Log Storage Configuration.....	62
Alarm/Event Storage Configuration.....	65
<b>FUNCTION BLOCK INFORMATION.....</b>	<b>67</b>
Accessing Context Sensitive Help.....	67
Right Mouse Click.....	67

---

<b>UTILITIES WORKSHEET .....</b>	<b>69</b>
Utilities Worksheet Overview .....	69
Controller Utility Functions .....	69
Set Controller Serial Ports .....	71
Modbus RTU Master - Advanced Setup .....	72
Set Controller Mode .....	75
Set Controller Network Parameters .....	75
Controller Identification .....	76
Set Controller Time .....	78
Data Storage Utility .....	81
Back Up Controller Information .....	82
Restore Controller Information .....	83
Manually Write Database to Flash .....	85
Diagnostics .....	86
Calibrate Modules .....	86
Calibrate CJ Temp .....	87
Calibrate AO Channel .....	88
Restore Factory Calibration .....	89
PPO Block Calibration Overview .....	89
Introduction .....	89
Calibration Procedures .....	89
<b>SET POINT PROGRAMMING .....</b>	<b>93</b>
Terms and Definitions .....	93
What is a Setpoint Program? .....	94
Setpoint Program Configuration Overview .....	96
<b>SETPOINT SCHEDULERS .....</b>	<b>97</b>
Setpoint Scheduler Overview .....	97
Setpoint Schedule Overview .....	97
<b>SEQUENCERS .....</b>	<b>99</b>
What is Sequence Control? .....	99
Sequence Configuration Overview .....	99
<b>RECIPES .....</b>	<b>101</b>
Recipe Overview .....	101
Recipes Menu .....	102
<b>RECIPES (VARIABLES) .....</b>	<b>103</b>
Introduction .....	103
Recipe Attributes .....	103
Recipe (Variables) Configuration Overview .....	103
Create/Edit Recipe (Variables) File .....	104
Recipe Pool .....	105
Setup/Edit a Recipe in Pool .....	105
Recipe Properties .....	106

<b>SETPOINT PROFILES .....</b>	<b>107</b>
Create/Edit Setpoint Profile File .....	107
Setpoint Profile Pool .....	109
Setup/Edit Setpoint Profile in Pool .....	109
Setpoint Profile Properties .....	110
<b>SETPOINT SCHEDULES .....</b>	<b>113</b>
Create/Edit Setpoint Schedule file.....	113
Setpoint Schedule Pool .....	114
Setup/Edit Setpoint Schedule in Pool.....	115
Setpoint Schedule Properties .....	116
<b>SEQUENCES.....</b>	<b>117</b>
Create/Edit Sequence File.....	117
Sequence Pool.....	119
Setup/Edit Sequence in Pool.....	119
Sequence Properties .....	120
<b>ON-LINE MONITORING .....</b>	<b>123</b>
Overview .....	123
Enter Monitor Mode .....	124
Visual Indicators for Monitor Mode.....	125
Monitor Update Rate.....	125
Monitor Toolbar.....	126
How Do I Start Monitoring.....	127
Right Click Procedure in Monitor Mode.....	127
Function Block Monitor Window .....	128
Forced Blocks Window .....	130
How Do I Stop Monitoring.....	130
Logic Flow.....	130
<b>WATCH SUMMARY WINDOW.....</b>	<b>136</b>
Watch Summary Window .....	136
<b>DIAGNOSTICS .....</b>	<b>143</b>
Controller Diagnostics.....	143
Controller Diagnostics Status Indications.....	145
Rack Diagnostics .....	151
Rack Diagnostics: Power Supply.....	153
I/O Module Diagnostics Status Indications.....	155
I/O Channel/Sensor Status .....	156
Controller Ports Diagnostics .....	160
<b>REPORTS.....</b>	<b>172</b>
Print Report.....	172
Print Report Preview .....	174
Export Report.....	175

---

<b>MODBUS REGISTER ADDRESSES.....</b>	<b>177</b>
Modbus Register Map Overview .....	177
Fixed or custom map .....	177
Fixed Map .....	178
Custom Map.....	180
<b>REDUNDANCY.....</b>	<b>183</b>
Redundancy System Status Indicators .....	183
Redundancy Link Status Indicators.....	184
Lead CPU Status Indicators .....	185
Reserve CPU Status Indicators.....	189
Scanner 2 Link Status Indicators.....	189
<b>INDEX .....</b>	<b>191</b>
<b>SALES AND SERVICE.....</b>	<b>194</b>



## Software Overview and Introduction

The HC900 recipe management, setup functions and routine maintenance activities are performed using HC900 Hybrid Control Utilities software on a PC operating with Windows™ 2000, XP or Vista Operating Systems.

Easy-to-use Windows-based software, operable over Ethernet or via an RS232 port or modem connection, simplifies routine setup operations. It provides advanced monitoring functions for debug, uploads the complete, annotated graphic controller and operator interface configuration, and supplies an array of printouts for enhanced documentation.

Once a configuration is installed into the controller and operator interface, the software may be used to develop or change recipes, edit data storage schedules, monitor areas of the configuration to verify proper operation, or perform calibration functions.

### Features

- Configuration upload that includes graphic configuration to recreate the function block diagram and OI assignments
- View OI data storage
- Configures recipes (Variables only), SP profiles, SP schedules, sequences with on-line operation, provides easy file generation for media transfer to HC900 OI's locally and file management. Items are configurable only if not part of a configuration.
- Configuration partitioning using "Worksheets"
- Extensive monitoring tools including watch windows, concurrent detailed block parameter windows, digital/logic power flow via color coding, live data at block pins, and a signal traceback facility
- Windows 2000, XP or Vista SP2 support
- Use Ethernet or RS-232 to access controller
- Perform I/O Calibration
- Analyze Diagnostic Information

### Worksheets

Worksheets are a logical partition of a configuration and selected by tabs that appear on the Main Window.

A configuration is built using four main elements (or Worksheets) of configuration.

The configuration originator may apply additional security to specific worksheets to prohibit access to proprietary operations while allowing other users to view unprotected worksheets or generate recipe and data storage files.

### Monitoring

On-line monitoring tools allow quick analysis of execution problems. These include:

- Multiple function blocks monitor access on a single display from multiple worksheets. Most internal parameters are available for read/write. Major blocks such as PID, Setpoint Programmer and Sequencers have dialog boxes to allow operation and test. Stored profiles or sequences may also be selected on-line.
- User-selected Watch Window lists allow access to digital and analog I/O, Signal Tags, Variables (for write actions). A user-defined watch window provides custom association of parameters for a debug session. Watch windows also allow write capability.
- Logic power flow indication using color-coded soft wiring for digital connections to and

between block pins including signal tags and connectors

- Live data at block pins (analog floating point or digital status) on a complete block or pin basis.
- Signal Trace-back, for any input to a block, for finding the signal sources for quick identification of potential errors.
- A Forced Blocks window shows all forced outputs .
- Data update selection as fast as 250 ms.

The user-selected, dockable Watch Window lists and Signal Trace-back finds the signal sources and provides a clear view of the configuration operation allowing quick identification of potential faults.

A FIND function allows location of multiple instances of specific tags, variables, and function blocks across all worksheets. A right click on any signal tag also allows selection of a "Find Where Used" listing for fast access to tag destinations and return to the tag source.

### **Configuration Download**

Configuration download capability allows the user to re-install a configuration after system maintenance or to install configuration changes made with HC Designer software.

### **Additional Software Functions**

Documenting your configuration is supported through a variety of printable presentation formats. A few of these include a summary of the controller I/O, the graphic configuration diagram, function block properties, recipe groups, setpoint profile groups, Operator Interface display and point selections, among others.

### **Recipe/Data Storage File Generation**

Recipes and data schedules may be created as files (via File New) for external file transfer to HC900 operator interfaces via storage media (floppy disk or ZIP disk) or for file management.

### **Reports**

Documenting your configuration is supported through a variety of report formats. Each can be print-previewed. A few of these include a summary of the controller I/O used, function block worksheet selection (each page of diagram worksheet printed as 8.5 x 11" sheet), function block properties, variable and tag parameters, Modbus addresses, Data Storage Settings, recipe listings, setpoint profile listings, sequencer listings, setpoint scheduler listings, OI display groups, Alarm and Event Groups, and controller setup.

## **Function Block Configuration development**

You can double-click on a block and open a Properties page in which you can view the specific parameters of that block.

Signal flow connections from icon to icon form the flow of the control strategy by using either software connections or named tags to complete the controller configuration.

You can display up to 20 graphic diagrams, 1 page high by 20 pages wide. The completed diagram may be printed on 20 pages of 8.5" x 11" paper. Completed configurations may also be saved on a 3.5" floppy disk and loaded into the controller through a 3.5" floppy disk drive in the operator interface unit, thus eliminating the need for a direct connection of a PC to the controller.

## Hardware and software requirements

<u>Specification</u>	<u>Description</u>
<b>PC Requirements</b>	CPU: Pentium, 1 GHz minimum (2.5GHz recommended)
<b>Operating System:</b>	Windows 2000, XP, Vista SP2
<b>Display Color:</b>	Minimum resolution (256 color x 1024 x 768 resolution)
<b>Pointing Device:</b>	Mouse, Trackball or compatible device
<b>RAM:</b>	64MB Minimum (512MB recommended)
<b>Removable Disk Drive:</b>	CD Drive
<b>Ports:</b>	RS232, Ethernet

---

### System Interconnection

#### If connected to the controller through its RS232 Port using PC Port (COM1 - COM8)

<b>Maximum Distance between Controller File and PC:</b>	50 Feet
<b>Cable Type:</b>	Standard 9 Pin null modemRS232
<b>Cable Termination:</b>	9-pin "D" connector.

#### If connected to the controller through its Ethernet Port:

<b>Maximum Distance between Controller File and PC:</b>	100 meters (368 feet) w/o repeaters
<b>Cable Type:</b>	CAT 5 shielded twisted pair IEEE 802.3
<b>Cable Termination:</b>	10/100 baseT RJ45

---

**Configuration:** On-line Monitoring allows the user to test the developed configuration.

---

### Modem Support

**PC Interface:** Supports Microsoft Windows Telephony API (TAPI) device independent modem communications. Baud rate = 9600, 19200, 38400.

**Controller Interface:** Connects to the controller RS-232 configuration port. Some commercially available modems with equivalent specifications to those validated should function with the HC900 controller. For validated Modems, see document 51-52-25-107 HC900 Controller and Installation Guide.

## How To Use This Help

To request Help on any area of the application, use one of the following methods:

- **HELP MENU**

This is the last item on the menu bar. Choose a Help topic from the Help menu.

***Help Topics***

From the Help menu, click “Help Topics”. The Help Contents tab appears. This is a list of all Help topics available including Menus, Configuration Parameters, and Toolbar. Selecting a topic causes information about that topic to be displayed. If the information about a topic exceeds the height of the window, a vertical scroll bar will be displayed.

***About Honeywell Hybrid Control Utilities***





Copyright or version information about the application.

- **RIGHT-CLICK FOR HELP TOPICS**

Right-click on any Function Block to access topic help for that particular Block.

### Help navigation

When you finish reading about a topic, you can choose one of the commands along the top of the help window to navigate through the help system.

	View the top-level Help Contents page.
	Return to previously viewed information. When you choose the Back button, you retrace your path through the help topics you have already viewed.
	Prints Help topic.
	Move forward one help screen.
	Move back one help screen.

## **What to Know Before You Start**

### **Rack, Module, and Channel Assignments**

The controller contains one or more racks. Each rack contains I/O modules and each I/O module contains a number of channels. Each rack, module and channel is assigned a number in the configuration that corresponds to a physical location in the installed racks.

Refer to the Honeywell Controller Installation and User Guide 51-52-25-107 for your Rack, Module, and Channel addresses for I/O Function Blocks in the Function Block Diagram configuration.



## Implementation

### Starting the Application

When the application is started, the only viewable part is the File Browser .

Go to the **Main Toolbar** or the **File Menu** and select:



**or NEW** - Displays a "Choose a New File Type" dialog box with three tabs.

**New Recipes:**

Select the "**Recipe**" tab. On the tab, click on a radio button to select one of the following:

Recipes (Variables)

Setpoint Profile

Setpoint Schedule

Sequence

Click OK. The associated "Editor" dialog box will appear and a new "Opened Recipe File" is listed in the File Browser. Refer to the specific Recipe type for specifics.

**New Data Storage:**

Select the "**Data Storage**" tab. On the tab, click on a radio button to create a new Data Storage File

or



**or OPEN.** - Displays the "Open" dialog box.

From the "Files of Type" drop-down menu, select a file type.

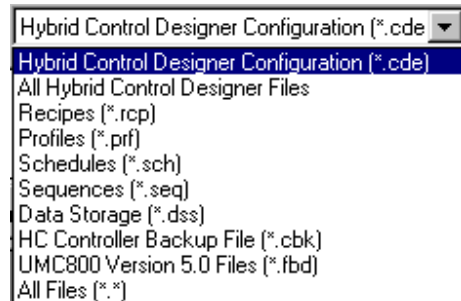

Navigate to folder where the file is stored.

Click on the desired file name, then click "OPEN".

or



**or Upload (Configuration)** - The Upload File dialog box will appear. A temporary file name will be placed in the "File Name" box.

Check the current connection. This will indicate over which communications port the upload will occur.

Change the current connection, if necessary, prior to beginning the upload.

Press "START". The dialog box will show "Percent Complete".

The Uploaded Configuration File (.cde) will appear with a temporary file name.

From the "File" menu, select Save or Save As and enter a file name and path in the appropriate fields.

or

## **Connecting the PC to the Controller**

The PC can be connected to the Controller by:

- Direct Serial RS-232 connection

- Modem connection via Remote Access.

- Direct Ethernet connection

- Networked Ethernet connection

For details refer to the HC900 Hybrid Controller Installation and User Guide, document 51-52-25-107, section "Connecting the HC900 Controller to a PC with the Hybrid Control Designer Software."

## User Interface

### User Interface Overview

The main components of the User Interface are:

[Main Menu](#)

[Main Toolbar](#)

[Worksheet Window\(s\)](#)

[File Browser](#)

[Status Bar](#)

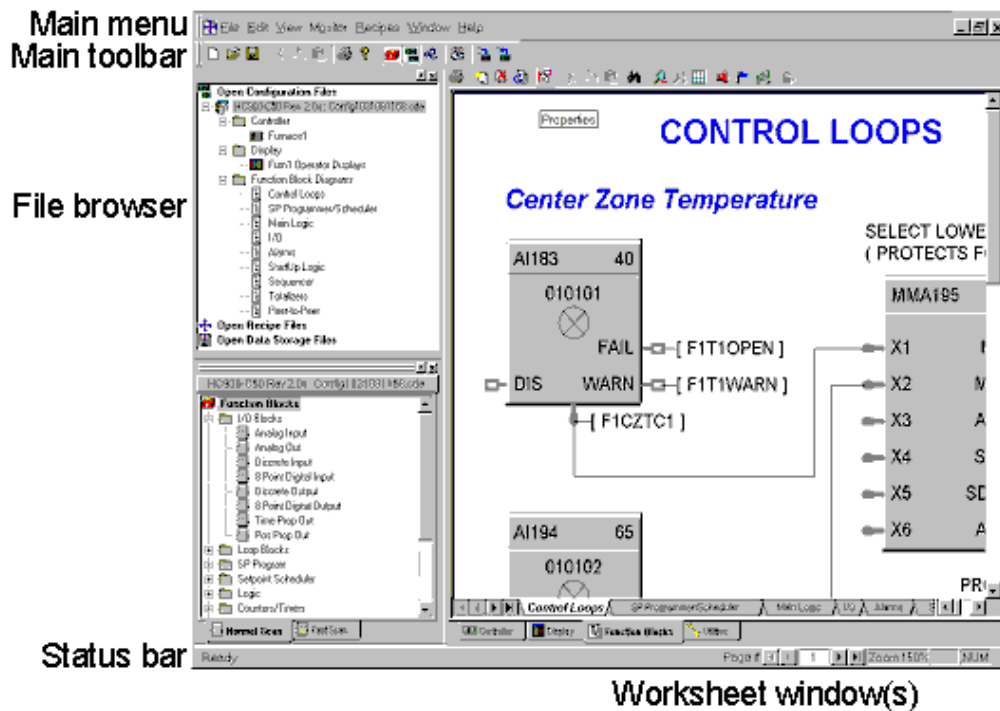

### General Terminology

Term	Definition
<b>Browser</b>	Defaults to the top left side of the Worksheet is a dockable window listing opened files. It allows you to move quickly between files and worksheets.
<b>Configuration Files</b>	A Configuration File contains a Control Strategy that you have created best suited for your application. All Open Configuration Files appear in the <a href="#">Browser Window</a>
<b>Recipe File</b>	A <a href="#">Recipe</a> File refers to one of 4 types of user files – a “Recipe” file consisting of Variables only, a Setpoint Profile, a Setpoint Schedule, or a Sequence.
<b>Data Storage File</b>	A <a href="#">Data Storage</a> File contains a data storage schedule for loading at the operator interface via storage media.

Term	Definition
<b>Function Blocks</b>	A <u>Function Block</u> is a unit of software that performs a set of operations on its <i>Input Signals</i> and <i>Function Block</i> parameters and produces <i>Output Signals</i> . These output signals can be configured as inputs to other blocks, whose output parameters can be configured as inputs to other function blocks, and so on.
<b>Main Window</b>	The <u>Main Window</u> contains Menus, toolbars and worksheet window plus other items that help you navigate through the application.
<b>Menu</b>	The Main Menu is a top-level menu for this application. You <u>select (highlight) a menu</u> and then choose a command from the drop-down menu. Choosing the command carries out the action.
<b>Status Bar</b>	The <u>status bar</u> is located along the bottom of the window. It indicates information about the current window, the time, the date, download, upload, monitoring and network information. This status bar can be displayed or not displayed from the "View" menu.
<b>Tab</b>	<p>A configuration is built using three main worksheet types: Controller, Display, and Function Blocks. Select the desired <u>tab</u> , located at the bottom of the configuration window for type of worksheet.</p> <p>There are also Tabs in the Function Block Diagrams that allow you to navigate around the multiple <u>FBD Worksheets</u>.</p>
<b>Toolbox</b>	The Worksheet Toolbox, located on the lower left side of the Worksheet, is a dockable window and lists all the function block by category separated by fast and normal scan tabs at the base of the toolbox. You can drag and drop function blocks onto FBD worksheets. A Configuration Tab lists all configured items. Click on any item to jump to it.
<b>Trace Window</b>	Helps you find problems with <u>soft-wire</u> and <u>signal connections</u> between Function Blocks.
<b>Watch Summary Window</b>	The <u>Watch Summary</u> window lets you monitor the following groups of data from the controller: Signal, Variables, I/O. OI Display Groups.
<b>Worksheet</b>	A Worksheet is a logical partition of a configuration. A configuration is built using three main <u>Worksheet</u> types: Controller, Display, and Function Blocks. A fourth worksheet type (Utilities) included Maintenance functions for the controller.

## File Browser Window

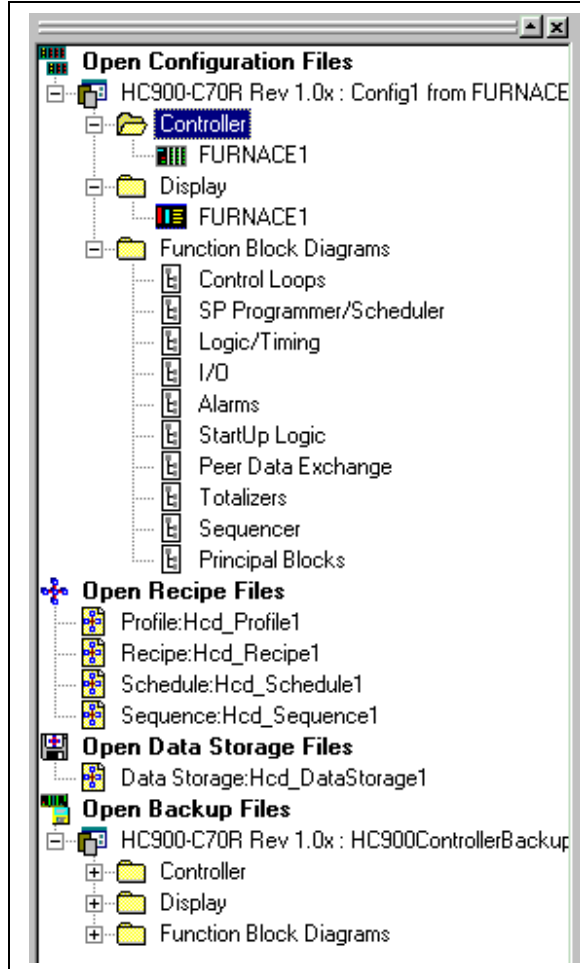

The File Browser is a dockable window listing open configuration files, open Recipe files, open Data Storage files and open Backup files.

It allows you to move quickly between open files and worksheets.

Double-click on a worksheet in the browser and it will make it the active view.

You can collapse or expand the tree and you can enlarge or shrink the size of the window.

It can be enabled or disabled from

The main menu (VIEW),

Main Toolbar button, or

Right click on the FBD white space (VIEW)

Right-click on a **Configuration Name** to close the configuration or view the File Properties .

Right-click on the **Controller** worksheet to view its properties. The "Controller's Identification" dialog box will appear. You can view the controller's name and the controller type and revision.

Right-click on a **Function Block Diagram** worksheet to view its properties.

**Protected Worksheets** will show a lock symbol in the worksheet icon.

Right-click on any open file name to close it.

## Worksheet Toolbox Window

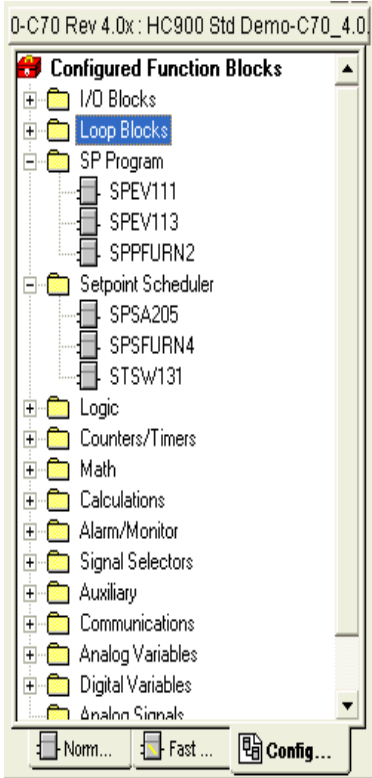
	<p>The Config tab shows all configured function blocks being used in the active configuration. Click on a folder to expand or collapse it. Right-click on a configured function block for the following options:</p> <ul style="list-style-type: none"><li>Properties – shows the properties of the block</li><li>Find – jumps to that block in the configuration</li><li>Execution Order – lets you change the execution order of the block</li><li>Help</li></ul>
--	---

## Traceback Window

### Overview

This feature helps you find problems with soft-wire and signal connections between Function Blocks.

### **For Example:**

If you are testing a configuration that you've built and want to know why a Digital Output is ON when it should be OFF, you can search for the source of the Input Signal.

**Traceback** is useful for finding the analog or digital source signal.

### Trace Window

Access the Trace Window from the Main Menu Toolbar 

Or, from the View Menu on the main menu.

Function Block	Tag Name	I/O Pin	Worksheet Name
SW126		OUT	#5 - FV's :
PID123	LOOP 3	PVI	#4 - Loops :
MDSw154		MDRQD	#3 - startup :
PID113	LOOP 1	MDRQI	#4 - Loops :
NOT156			#3 - startup :
SPS109	SPS109	SET	#2 - setpoints :
SPS109	SPS109	SP1	#2 - setpoints :
PID113	LOOP 1	RSP	#4 - Loops :

It is a dockable, sizeable window.

The Trace Window provides a list of all blocks/pins you have traced and lists :

- Block ID
- Tag Name
- I/O Pin Name
- Worksheet name

### Trace Window Update

Each time you perform a Trace, the window will update with a new pair of block/pins.

The **first item** is the **signal source**, the **second item** is the **signal destination**.

**Select any of the rows in the Traceback window to recall the diagram to display the selected block.**

***The last trace is on the top of the list.***

### Right Mouse Click Procedure to Trace Signals

Select a Function Block of interest.

Right Mouse click on any INPUT pin.

Select "TRACE". Traceback will "find" the source of the connection you selected and refresh the FBD view with that block visible (Highlighted) - even if the other side of the connection is on a **different** worksheet.

The Output pin of the block (the signal source) will be displayed in RED.

From that block, repeat the traceback to another block and another block, etc.

Use the Traceback list to view your Traceback history.

You can clear the Trace List by pressing the bar at the top of the window.

## Watch Summary Window

### Overview



accesses the Watch Summary Window from the Monitor Toolbar

Or, the menu item "Watch Summary" from the Monitor Menu on the main menu.

This is a view of the Watch Summary Window. It is a Dockable (movable), sizable window.  
[Press and hold the CTRL key down to prevent Docking when moving the window]

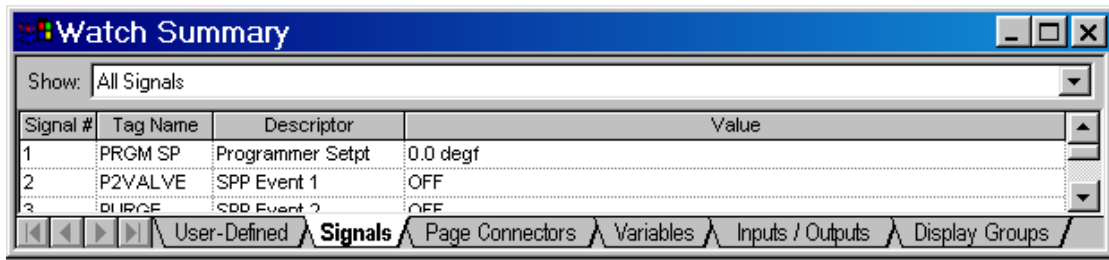

There are five tabs at the bottom of the window that lets you monitor the following groups of data from the controller. Click on any of the tab titles below **to view an example** of the selected data for that tab. All parameter listings may be **sorted** by column.

User Defined (Customized list of Variables, Signal Tags, Page Connectors)

Signals (can be filtered by type - All, Analog, Digital)

Page Connectors (can be filtered by type - All, Analog, Digital)

**Variables** (can be filtered by type - All, Analog, Digital)

I/O (can be filtered by type - AI, AO, DI, DO)

OI Display groups (Overviews, Panel Meters, Alarms, Trends, etc)

### Docking and Undocking the Window

Double clicking in the Title Bar area of the Watch Summary Window will toggle its docked state. If the window is docked, double clicking in the title bar area will undock the window.

If the window is Undocked

- double-clicking in the title bar area will dock the window at it last docked position
- Dragging the window to the top, bottom, left, or right edge of the main viewing area of the application will dock the window at that location

[Press and hold the CTRL key down to prevent Docking when moving the window]

### Hot Links

You can click on any I/O function block or Signal on the Controller Worksheet or any I/O function block, Signal, or Variable in the Watch Window and that item will be located on the Function Block Diagram.

As you move the mouse over a HOT LINK, the text changes to Underlined Blue and the cursor changes to a Hand. 

## Writes or Forces

By clicking on the item in the Value column, you may write a value such as for a Variable or force a value for an analog input or digital input. For I/O, a Forced column will indicate that the I/O point is forced.

## Status Bar

The status bar is located along the bottom of the application's window. It indicates information about the current window. It can be turned on or off in the "View" Menu.

**Menu Item Description** - The text string at the far left on the status bar gives a brief description of the menu item in focus. If you pull down a menu list and position the cursor on a menu item this field will describe the menu item.



**Connected Field** - To the left of the Page Number indicator are two fields that are visible when you are in Monitor Mode. One indicates "Connected" and the other is a green LED that flashes when communications is active between the PC and controller.

**Worksheet Page Number** - To the left of the Zoom indicator is a page number field. This will display the page number of the **current FBD Worksheet**. It is blank for other worksheet types (Display, Controller, and Utilities). There are scroll buttons to navigate through pages of the worksheet.

**Zoom Level** - indicates the level of Zoom active on the worksheet. (i.e 100%)

**Active Keyboard Keys** - Toward the far right, you will see indicators to alert the user that the Caps Lock key on the keyboard is active, the NUM lock on the keyboard is active, or the SCRL (Scroll Lock) key is active.

## Menu Conventions

### Menu conventions

The following menu conventions are used:

Menu Convention	Meaning
Dimmed command	You will not be able to use this command at the current time. (For example: You may need to select another item before using this command.)
An ellipsis (...) following a command	A dialog box will appear when you choose this command. The dialog box contains options you need to select before the command can be completed.
A check mark next to a command	The command is in effect. When you remove the check mark (by selecting the command), the command is no longer in effect.
A key combination next to a command	The key combination is a keyboard accelerator <i>shortcut</i> for this command. You can use this key combination to choose this command.
A triangle next to a command	When you choose this command, a cascading menu appears, listing additional commands.

## Selecting a Menu

### Selecting a menu

In this application, you select (highlight) a menu and then choose a command from that menu. Choosing the command carries out the action.

To choose an item from a selected menu:

#### Mouse

Using the mouse pointer, point to the name of the menu on the menu bar, and click the left mouse button. This opens the menu. To move directly to a menu item, drag the selection cursor down the menu until the desired item is highlighted, then release the button.

#### UP/Down Arrow Keys

Press the "ALT" key to highlight the menu bar then use the UP/Down arrow keys on the keyboard to select the item, then press "Enter".

#### Underlined Letter

If a name in the menu bar has an underlined letter you can press ALT and then type the letter that's underlined to open the menu.

*For example: to open the FILE menu in the Hybrid Control Utilities main window, press ALT+F.*

## Closing a Menu

To close a menu:

- Click the menu name or anywhere outside the menu, or
- Press ESC to close the menu but remain on the menu bar so that you can make another selection



## Main Menu



The Main Menu is located across the top of the User Interface. The menus are:

File Menu  
Edit Menu  
View Menu  
Monitor Menu  
Recipes Menu  
Window Menu  
Help Menu

## File Menu

Menu Selection	Function
<p><b><u>N</u>ew</b></p> <p>Toolbar: </p>	<p>Displays a "Choose a New File Type" dialog box with these tabs:</p> <p><b>New Recipes:</b> Select the "<b>Recipe</b>" tab. On the tab, click on a radio button to select one of the following:</p>

Menu Selection	Function
<p><i>Shortcut:</i> CTRL+N</p>	<p><u>Recipes (Variables)</u> <u>Setpoint Profile</u> <u>Setpoint Schedule</u> <u>Sequence</u></p> <p>Click OK. The associated “Editor” dialog box will appear and a new “Opened Recipe File” is listed in the File Browser. Refer to the specific Recipe type for specifics.</p> <p><b>New Data Storage:</b> Select the “Data Storage” tab. On the tab, click on a radio button to <u>create a new Data Storage File</u></p>
<p><b>Open ...</b></p> <p><i>Toolbar:</i> </p> <p><i>Shortcut:</i> CTRL+O</p>	<p>Displays the “Open” dialog box. From the “Files of Type” drop-down menu, select a file type.</p>  <p>Navigate to folder where the file is stored. Click on the desired file name, then click “OPEN”.</p> <p>Opens files and converts UMC800 (*.FBD) configuration files.</p>
<p><b>Close</b></p>	<p>Closes the active document window. It will also close a minimized window if active. [It will not close an active dialog box.]</p>
<p><b>Save</b></p> <p><i>Toolbar:</i> </p> <p><i>Shortcut:</i> CTRL+S</p>	<p>Saves the active configuration.</p> <p>First time save displays the “Save As” dialog box.</p>
<p><b>Save As ...</b></p>	<p>Displays the “Save As” dialog box. Prompts user to name the active configuration and select the file in which the file is to be stored.</p>
<p><b>Download</b></p>	<p><u>Configuration Download</u> transfers a saved configuration <b>FROM</b> the PC <b>TO</b> the controller.</p> <p>The Controller may be in either RUN or PROGRAM mode.</p>
<p><b>Upload Configuration</b></p>	<p>Configuration Upload transfers a configuration <b>FROM</b> the controller <b>TO</b> the PC including graphic function block pages, text annotations, stored recipes/profiles/schedules/sequences, OI display assignments, OI data storage setup. The uploaded file name, as a default, will include the controller name, alias name (if assigned) and network name (if assigned).</p> <p>The Controller may be in ANY mode.</p> <p><b>No configuration file is required to be opened</b> prior to the Upload Request</p>
<p><b>Upload...</b></p>	<p>Opens the “Upload” dialog box that lists the type of recipes available to upload. Click on a radio button to select one of the following:</p>

Menu Selection	Function
	<p>Recipes (Variables) Setpoint Profile Setpoint Schedule Sequence Data Storage.</p> <p>Upload transfers a recipe <b>FROM</b> the controller <b>TO</b> the software.</p>
<b>Back up Controller...</b>	<p>Saves a controller's active configuration as a backup file with .cbk extension. Similar to saving an uploaded configuration except that the configuration <i>and</i> port settings are saved. You are prompted to specify the comm. link settings for the controller to be backed up. Backup files are read-only; to edit you must first save as .cde. See <a href="#">Back Up Controller Information</a> for more details.</p>
<b>Hang Up Modem</b>	<p>When communicating with a controller via a Modem, select this to disconnect the Modem from the controller.</p>
<b>Properties ...</b>	<p>Displays the "<a href="#">File Properties</a>" dialog box.</p> <p>Tabs allow user to view Configuration <b>File properties</b>, read Configuration File <b>Statistics</b> (capacity usage).</p>
<b><u>W</u>rite Protect File ...</b>	<p>Displays the "<a href="#">Add Write Protection</a>" dialog box. Can enter and confirm a password for the selected file.</p>
<p><b>Print Report</b></p> <p></p> <p>Toolbar: </p> <p>Shortcut: CTRL+P</p>	<p>Displays the "Print Report" Dialog box.</p> <p>Lets you choose <u>reports</u> for printing from 5 different categories:</p> <ul style="list-style-type: none"> <li>Controllers</li> <li>Function Block Diagrams</li> <li>Displays</li> <li>Recipes</li> <li>Alarms and Events</li> </ul>
<b>Print Report <u>P</u>review</b>	<p>Lets you choose a <u>report preview</u> (Print Preview) for printing from the 5 categories:</p> <ul style="list-style-type: none"> <li>Controllers</li> <li>Function Block Diagrams</li> <li>Displays</li> <li>Recipes</li> <li>Alarms and Events</li> </ul> <p>The selected report is displayed on the screen as it will look when printed.</p>
<b>Export Report</b>	<p>Lets you <u>export reports</u> as files in comma or tab separated format.</p>
<b><u>P</u>rint Setup ...</b>	<p>Displays "<a href="#">Print Setup</a>" dialog box. Allows user to select printer, paper type, and orientation.</p>
<b>Most Recent Files</b>	<p>Lists the most recent files that were open.</p>
<b><u>E</u>xit</b>	<p>Exits the application.</p>

## Edit Menu

Menu Selection	Function
<b>Worksheet <u>P</u>roperties...</b>	Opens the "Worksheet Properties" dialog box. Allows you to view the Title and Description of the worksheet. Type in a title (24 characters ) and description (32 characters) for your Worksheet -.
<b><u>U</u>nlock Worksheets</b>	Displays "Unlock Worksheets" dialog box. Enter password to unlock all protected worksheets. Click on "Unlock".
<b><u>B</u>lock and Tag Order</b>	<p>Opens the " <u>B</u>lock Execution Order" or the "Fast Block Execution Order" dialog box to let you view block execution order. Also available from FBD worksheet toolbar.</p> <p>Select "Tag Order" to re-arrange the tags order for:</p> <ul style="list-style-type: none"> <li><u>A</u>lternator Operates</li> <li><u>D</u>evice Controls</li> <li><u>H</u>OA Switches</li> <li><u>L</u>oops</li> <li><u>R</u>amp Operates</li> <li><u>S</u>equencers</li> <li><u>S</u>P Programmers</li> <li><u>S</u>P Schedulers</li> <li><u>S</u>tage Operates</li> </ul>
<b><u>A</u>larms</b>	Opens the "Alarm Group Configuration" dialog box. Lets you <u>V</u> iew alarm groups . Also available from FBD worksheet toolbar.
<b><u>E</u>vents</b>	Opens the "Configure Event List" dialog box. Allows you to view events. Also available from FBD worksheet toolbar.
<b><u>M</u>odbus Register Map...</b>	Available for configuration revision 2.0 or higher. Lets you view but not edit " <u>E</u> dit Modbus Register Addresses " dialog box.
<b><u>T</u>rend Backfill Log Point Selection</b>	Available for configuration revision 4.4 or higher. Lets you view but not select method for configuring points to be saved in the trend history buffer.
<b><u>F</u>ind</b> <i>Shortcut: CTRL+F</i>	Searches for an item on the "Find Item" dialog box. Select an item type from the "Show" drop-down menu to search, then select an Item from the "Item" drop down menu. The Tag, Variable, or Function Block will be highlighted on the Function Block Diagram.
<b><u>G</u>o To</b> <i>Shortcut: CTRL+G</i>	Displays the " <i>Enter Page Number</i> " dialog box and allows you to enter the page number to which you want to go. (1-20)
<b>Options</b>	<p>Options are:</p> <p><b><u>W</u>arning Level</b></p> <p>Allows enable/disable of Open Input and Unassigned I/O warnings. Click on Box to select.</p> <p><b>Export Delimiter</b></p> <p>Allows setting of export report's default format (comma delimited or tab</p>

User Interface  
Edit Menu

---

	delimited).
--	-------------

## View Menu

Menu Selection	Function
<b>Toolbar</b>	Displays or hides the <u>toolbar</u> in the top of the Main window. Gray box with √ mark indicates display.
<b>Status Bar</b>	Displays or hides the <u>status bar</u> at the bottom of the Main window. Gray box with √ mark indicates display.
<b>File Browser</b>	Displays or hides the <u>File Browser</u> at the top left of the Main window. Gray box with icon indicates display.
<b>Trace Window</b>	Allows you to view the <u>Traceback</u> list.
<b>Phone Book</b>	Opens the "Select the Number to Call" dialog box. Lets you add and delete phone number on the list.
<b>Network Device List</b>	Lets you setup a PC Network Port for interface to a specific controller. See <u>PC Network Port Set Up</u> .
<b>PC Serial Port Setup</b>	Lets you setup up to 8 PC Serial Comm ports for interface to a specific controller. See <u>PC Serial Com Port Setup</u> .
<b>Grid</b>	Displays or hides a Grid on the <u>FBD Worksheet</u>
<b>Zoom Out</b>	Lets you Zoom in out to see more of a document. Zoom levels of 50%, 75%, 100%, 125%, and 150%. Also available from <u>FBD worksheet toolbar</u> .
<b>Zoom In</b>	Lets you zoom in to return items to normal size. Zoom levels of 50%, 75%, 100%, 125%, and 150%. Also available from <u>FBD worksheet toolbar</u> .

## Monitor Menu

Menu Selection	Function
<b>Monitor Mode</b>	Enters or exits monitor mode. <b>While in monitor mode, edits to the configuration cannot be made.</b> If entering monitor mode, selecting this menu item opens the " <a href="#">Enter Monitor Mode</a> " dialog box.
<b>Monitor Toolbar</b>	The <a href="#">Monitor Toolbar</a> toggles each monitor window.
<b>Set Update Rate</b>	You can specify the monitor update rate that determines how often data is collected from the controller during monitoring.
<b>Watch Summary Window</b>	Toggles the <a href="#">Watch Summary Window</a> that lets you view groups of related data such as I/O and Signal Tags.
<b>Controller Diagnostics</b>	Toggles the <a href="#">Controller Diagnostics Window</a> that lets you view the controller parameters and values.
<b>Rack Diagnostics</b>	Toggles the <a href="#">Rack Diagnostics</a> window that lets you view the <a href="#">Rack Diagnostics</a> , <a href="#">Expansion I/O Comm</a> Diagnostics(except C30 CPU) and the I/O Module parameters and indicators.
<b>Controller Ports Diagnostics</b>	Toggles the <a href="#">Configuration Port Diagnostics</a> window that lets you view the Configuration Port parameters and values. <a href="#">Serial Port S1</a> <a href="#">Serial Port S2</a> <a href="#">Network Port</a> <a href="#">Expansion I/O Comm</a> (except C30 CPU) <a href="#">Host Connections</a> <a href="#">Peer to Peer Connections</a>
<b>Modbus Master Ports Diagnostics</b>	Toggles the <a href="#">Modbus Master Port Diagnostics</a> window that displays the status of the Modbus Master port.
<b>Monitor Function Block</b> <i>Shortcut: CTRL+M</i>	Toggles the <a href="#">Function Block Monitor Windows</a> that lets you monitor all the parameters of the selected Function Block.
<b>Forced Blocks</b>	Toggles the <a href="#">Forced Block Summary</a> Window that lets you see all the outputs that are being forced and permits release of the force condition for a selected output.
<b>All Function Block Windows</b>	Allows you toggle the function block windows that are open - On/Off.
<b>All Pins</b>	Lets you toggle monitoring values (numeric or On/Off state) at any input or output pin – Display or Hide.
<b>All Monitor Windows</b>	Allows you toggle the Monitor windows that are open - On/Off.
<b>Redundancy...</b>	Accesses <a href="#">Redundancy</a> diagnostics. <a href="#">Redundancy System</a> <a href="#">Redundancy Link</a> <a href="#">Lead CPU</a> <a href="#">Reserve CPU</a> <a href="#">Scanner 2 Link</a>

## Recipes Menu

Accesses all recipe pools. To learn about the different recipe types read Recipe Overview.

Menu Selection	Function
<b>Allocate Recipe Memory</b>	Allocates the controller's memory for the four recipe types. This is the number of recipes that can be stored in the controller's four recipe pools. Recipes in these pools can be loaded and run by Recipe Selection Blocks, Programmers, Schedulers, and Sequencers. As recipe memory usage increases, less memory is available for other parts of your configuration (such as function blocks).
<b>Setpoint Profiles...</b>	Setpoint Program (Profile) configuration provides a quick and easy way to create, edit, and save different ramp/soak (setpoint) profiles for the Setpoint Programmer (SPP) control blocks in the configuration. This selection opens the Setpoint Profile Pool dialog box and allows viewing, adding, editing, and printing of Setpoint Profile details. You can save the selected SPP item to a file; open a SPP file and insert it into the pool; and download the selected SPP item to a controller's Setpoint Profiles pool.
<b>Setpoint Schedules...</b>	Setpoint Schedule configuration provides a quick and easy way to create, edit, and save different Setpoint Schedules for the Setpoint Scheduler (SPS) control blocks in the configuration. This selection opens the Setpoint Schedule Pool dialog box and allows viewing, adding, editing, and printing of Setpoint Schedules details. You can save the selected SPS item to a file; open a SPS file and insert it into the pool; and download the selected SPS item to a controller's Setpoint Schedule pool.
<b>Sequences...</b>	Sequence configuration provides a series of inter-related events used to start-up or shut-down a unit process, or a series of timed and process measurement dependent events that are executed to produce a final product. This selection opens the Sequence Pool dialog box and allows viewing, adding, editing, and printing of Sequence details. You can save the selected SEQ item to a file; open a SEQ file and insert it into the pool; and download the selected SEQ item to a controller's Sequence pool.

## Window Menu

Menu Selection	Function
<b>C</b> ascade	Arranges windows so that they overlap making it easy to select a window.
<b>T</b> ile <b>H</b> orizontally	Arranges windows side by side. Each window is visible and none overlap.
<b>T</b> ile <b>V</b> ertically	Arranges windows over and under each other. Each window is visible and none overlap.
<b>A</b> rrange <b>A</b> ll	Arranges configuration Icons when configurations are minimized.
<b>(Open window designations)</b>	Lists all Function Block Diagrams, recipes, and data storage files that are open and checks the one that is active. Click any file to display it.

## Help Menu

### **MENU SELECTIONS**

#### **H**elp Topics

Calls up the top level Helps Contents page.

Selecting a **Topic** displays information about that topic. If the information about a topic exceeds the height of the window, a vertical scrollbar will be displayed.

Selecting the **Index** tab lets you type in the first few letters of the word you are looking for.

Selecting the **Find** tab lets you search for specific words and phrases in Help topics, instead of searching for information by category.

#### **A**bout Help

Displays copyright and software version, and user name and company name entered during software's installation.

### **ADDITIONAL HELP ACCESS**

#### **Right-click Help for Help Topics**

Right-click on any Function Block to access topic help for that particular Block









#### **H**otspots

When the cursor is over a hotspot area on an image, it turns to a hand indicating that when clicked some sort of action occurs.

## Main Toolbar Functions

Click on **ICON** to open a dialog box.

ICON	Function	Dialog Box Comments
	<b>New</b>	Displays a "Choose a New File Type" dialog box with these tabs. <b>New Recipes:</b> Select the " <b>Recipe</b> " tab. On the tab, click on a radio button to select one of the following:

ICON	Function	Dialog Box Comments
		<p>Recipes (Variables) Setpoint Profile Setpoint Schedule Sequence</p> <p>Click OK. The associated "Editor" dialog box will appear and a new "Opened Recipe File" is listed in the File Browser. Refer to the specific Recipe type for specifics.</p> <p><b>New Data Storage:</b> Select the "Data Storage" tab. On the tab, click on a radio button to create a new Data Storage File</p>
	<b>Open</b>	<p>Displays the "Open" dialog box. From the "Files of Type" drop-down menu, select a file type.</p> <div data-bbox="579 655 1035 959" style="border: 1px solid black; padding: 5px;"> <p>Hybrid Control Designer Configuration (*.cde) ▾  Hybrid Control Designer Configuration (*.cde)  All Hybrid Control Designer Files  Recipes (*.rcp)  Profiles (*.prf)  Schedules (*.sch)  Sequences (*.seq)  Data Storage (*.dss)  HC Controller Backup File (*.cbk)  UMC800 Version 5.0 Files (*.fbd)  All Files (*.*)</p> </div> <p>Navigate to folder where the file is stored. Click on the desired file name, then click "OPEN".</p> <p>Opens files and converts UMC800 (*.FBD) configuration files.</p>
	<b>Save</b>	<p>Saves the active configuration. First time save displays the "Save As" dialog box.</p>
	<b>Print</b>	<p>Displays the "Print Report" Dialog box.</p> <p>Lets you choose reports for printing from 5 different categories:</p> <ul style="list-style-type: none"> <li>Controllers</li> <li>Function Block Diagrams</li> <li>Displays</li> <li>Recipes</li> <li>Alarms and Events</li> </ul>
	<b>Help Topics</b>	<p>Opens Help Topics Table of Contents and Help information screen.</p>
	<b>File Browser</b>	<p>Displays or hides the File Browser Window.</p>
	<b>Traceback Window</b>	<p>Displays or hides the Traceback Window.</p>
	<b>Monitor Mode</b>	<p>Enters/Exits Monitor Mode and allows On-line Monitoring and Diagnostics. <b>When pressed</b>, the active configuration is in the Monitor mode (and cannot be edited). <b>When not pressed</b>, the active configuration is in the edit mode.</p>
	<b>Upload</b>	<p>Opens the "Upload File" dialog box. Press start to Upload file selected from the controller.</p>

## Navigational Tools

Navigational Tools available:

Main Menus and Main Window Toolbar  
File Browser Window  
Worksheet Category Tabs  
Worksheet Toolbars (Controller, Display, Function Block Diagram, Utilities)  
Find / Go To  
Function Block Help (right mouse click on block)  
Connection Traceback Window  
Finding an Item on the FBD Worksheet  
Hot Links  
Keyboard Navigation

## Right Mouse Click

Shown below are the right-click menus. See also Right Click In Monitor Mode.

### Right Click On Function Block Object (not pins)

Help - *Calls up Topic Help for Function Block selected*

Execution Order

View Modbus Register Address

Properties

### Right Click on Connected Function Block Input Pins

Trace

### Right Click on Variable

Help - *Calls up Topic Help for Function Block selected*

Execution Order

View Modbus Register Address

Properties

### Right Click on Signal Tag

Help – calls up help

Find Where Used – Opens Find dialog box. Lets you locate any and all places where the signal tag is used.

View Modbus Register Address

Properties

### Right Click on Page Connector

Help – calls up help

Find Where Used – Opens Find dialog box. Lets you locate any and all places where the page connector is used.

View Modbus Register Address

Properties

### Click On FB Diagram White Space

- Execution Order
- Fast Logic Order
- Find
- Go To
- View (displays the view menu)
- Properties [File]

### Right Click On Function Block in Worksheet Toolbox Configuration Tab

- Properties [File]
- Find
- Execution Order
- Help – calls up help

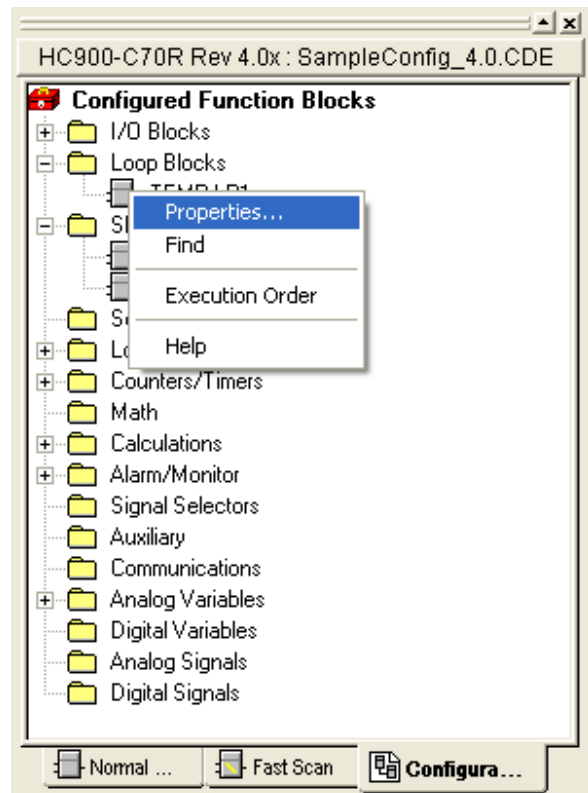

## Keyboard Navigation

Press	To
LEFT ARROW	Scroll worksheet to the left
RIGHT ARROW	Scroll worksheet to the right
UP ARROW	Scroll worksheet up
DOWN ARROW	Scroll worksheet down
END	Go to the end of last page

HOME	Go to the beginning of first page
PAGE DOWN	Go to the next worksheet page
PAGE UP	Go to the previous worksheet page
CTRL+LEFT ARROW	Go to the end of last page
CTRL+RIGHT ARROW	Go to the beginning of first page
CTRL+UP ARROW	Go to the top of the page
CTRL+DOWN ARROW	Go to the bottom of the page
CTRL+PAGE DOWN	Go to the next worksheet tab
CTRL+PAGE UP	Go to the previous worksheet tab

### Other keyboard functions

If necessary, you can use the standard keystroke conventions to move around.

**ALT** *used together with the underlined letter in text labeling an object lets you select that object.*

**TAB** *select next field or object in dialog boxes and configuration templates*

**SHIFT+TAB** *select previous field or object in dialog boxes and configuration templates*

**UP ARROW** *previous choice in the field*

**DOWN ARROW** *next choice in the field*

**ALT+DOWN ARROW** *opens a drop-down list box*

## File Management

### Opening an Existing File

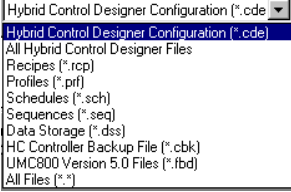
<p>Select "Open" from the File Menu...</p> <p>or</p>  <p>from the Main Toolbar</p> <p>Shortcut: CTRL+O</p>	<p>Displays the "Open" dialog box. Drop-down the "Files of Type" menu and select a file type.</p>  <p>Navigate to folder where the file is stored.</p> <p>Click on the desired file name, then click "OPEN".</p>
<p>or</p>	<p>From the "File" menu, select one of the most recently opened file listed above the "Exit" item.</p>

### Saving A Configuration File

To Save an Existing File

Select "SAVE" from the "FILE" menu or from the Main Toolbar



To Save a New File or Save the File as a New Name

Select "SAVE AS" from the "FILE" menu. The "Save As" dialog box will open.

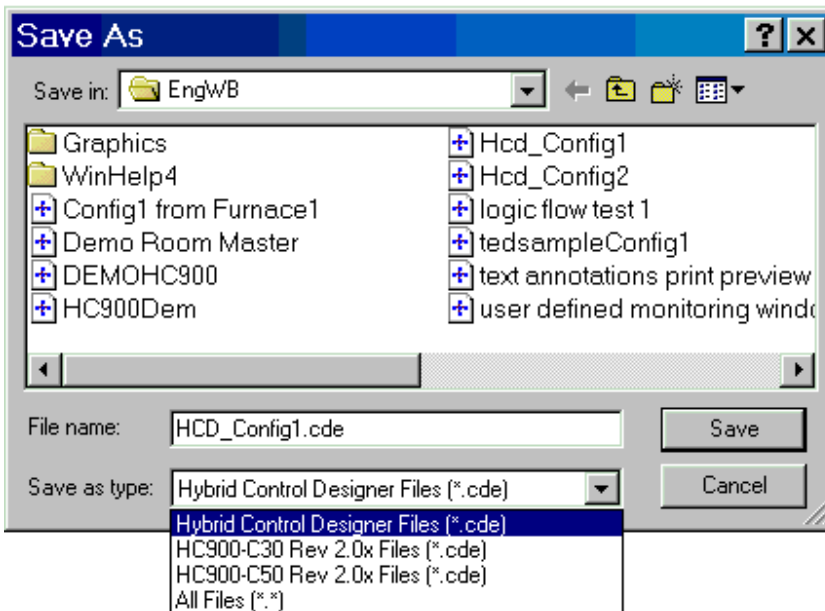

Type in the new file name in that field.

From the drop-down menu in the "Save as Type" field, select the configuration type depending on the controller you have.

## Creating Other File Types

See sections for details.

[Create/Edit Recipe \(Variables\)](#)

[Create/Edit Setpoint Profile](#)

[Create/Edit Setpoint Schedule](#)

[Create/Edit Sequence](#)

[Create/Edit Data Storage Settings](#)

[Back up Controller Information](#)

## Uploading a File from the Controller

### Introduction



Upload transfers a file **FROM** the controller **TO** the PC. Uploadable files are configurations, recipes, and data storage.

The Controller may be in ANY mode.

**No configuration file is required to be opened** prior to the Upload Request.

### Uploading Configuration

From the "File Menu" select Upload Configuration, or click on the Upload icon on the Main

Toolbar , or click on the Upload icon on the Utilities Worksheet Toolbar , then select "Upload Configuration".

The Upload File dialog box will appear. A temporary file name will be placed in the "File Name" box.

Under "Current CommLink Settings", select the port and address to communicate to a controller. Reference "Utilities WorksheetUtilities\_Worksheet\_Overview" for configuring the PC Ports.

Press "START". The dialog box will show "Percent Complete".

The Uploaded File will appear with an automatic file name containing the controller name, its local name (or alias), and the network it is on.

From the "File" menu, select Save or Save As and enter a file name and path in the appropriate fields.

### Uploading Recipe or Data Storage

From the "File Menu" select **Upload...** The Upload File dialog box will appear. A temporary file name will be placed in the "File Name" box.

Under "Current" CommLink Settings", select the port and address to communicate to a controller. Reference "Utilities Worksheet" for configuring the PC Ports.

Press "START".

Select a file type to upload. If uploading a recipe you'll be asked to choose which recipe in the controller's memory to upload.

The dialog box will show "Percent Complete". When the upload is complete, the Uploaded File will appear (with a temporary file name) in the editor for that file type.

From the "File" menu, select Save or Save As and enter a file name and path in the appropriate fields.

## Downloading a File to the Controller

### Introduction

Once a control strategy—configuration file—is opened, Configuration Download transfers a configuration **FROM** the PC **TO** the controller.

The Controller may be in either RUN or PROGRAM mode (not Run-Locked)

**ATTENTION: You cannot download an HC900-C50 configuration to an HC900-C30 and vice versa. You must first convert the configuration before doing a download. See "Converting HC900 configurations".**

### Procedure

From the File Menu select "Open" or Upload a file\* from the controller.

Select the file (.cde) that is to be downloaded.

The selected function block diagram will appear in the Active View window. **Only the active file window can be downloaded.**

From the "File Menu" select **Download** or

click on the **Download icon** on the Main Toolbar , or

click on the **Download icon** on the *Utilities Worksheet* Toolbar  then select "Download Configuration".

The "Download File" dialog box will appear. Check the Port and Address information for correctness.

Press "START" to download the configuration to the configuration buffer.

The **download will begin** if the controller is in:PROGRAM mode or RUN mode.

The **download will be rejected** if the controller is in:RUN/LOCKED mode or OFFLINE mode.

The dialog box will show "Percent Complete".

After the database tables have been transferred to a configuration buffer, select one of the following commands to transfer from the buffer to the controller:

**HOT START** - the controller will use the new or updated configuration in RUN Mode.

During a Hot Start:

- Controller memory will not be re-initialized
- Outputs will be held at their current value.
- Controller will stay in RUN mode

There are two possible actions with a Hot Start.

- If the Hot Start will be completed within approximately 3 controller scan cycles, then the Hot Start will proceed automatically.
- If the Hot Start requires longer than 3 controller scan cycles, a dialog box displays a) the estimated duration of the Hot Start and b) options to initiate or cancel the Hot Start.

**COLD START** - the controller will transition through normal PROGRAM-TO-RUN mode transition

- Controller memory will be re-initialized
- Outputs will be turned off during re-start
- Controller will return to RUN mode

**ABORT** - the controller will disregard the new configuration and continue to use the previous configuration.

The dialog box status line will state "Mode Change in Progress" then "Download Successful" when completed.

## Downloading in Run Mode



### WARNING

While we provide application assistance personally, through our literature and the Honeywell web site, it is up to the customer to determine the suitability of the configuration in the application and the potential dangers of downloading a configuration while running.

Downloading in RUN Mode has the potential to create a hazardous situation. Changes to the configuration result in a short suspension of the control program followed by an immediate execution of the new configuration. It is the user's responsibility to ensure that configuration changes will not result in a hazardous situation.

It is the user's responsibility to assess this risk for his process. Failure to comply with these instructions could result in death or serious injury to people and/or property damage.

Downloading in Run Mode (Hot Start) is a means to make configuration changes and download them to the controller without taking the process off-line.

It is intended for **incremental changes to a running configuration**, such as:

- Adding and Deleting Blocks
- Modifying block configuration parameters
- Adding/changing soft-wires, signals, variables
- Adding OI displays, Data Storage
- Adding Recipes, SP Profiles, SP Schedules, or Sequencers.
- Adding, deleting, or modifying I/O (DI, DO, AI, AO).

**IMPORTANT:** If you intend to make a set of changes to a running configuration and wish to preserve the context of the current configuration parameters you should perform an upload from the controller first to assure that you have the current configuration, make the incremental changes, and then download.

## Cautions

### Configuration Change Transfer

Once the HOT START button is depressed, the configuration will be updated with the new changes. Note: During the time period required to perform the Hot Start, the controller will suspend the execution of its function blocks and hold its outputs at their current value. If you select Hot Start and the Hot Start will take longer than approximately three controller scan cycles, a popup window appears:

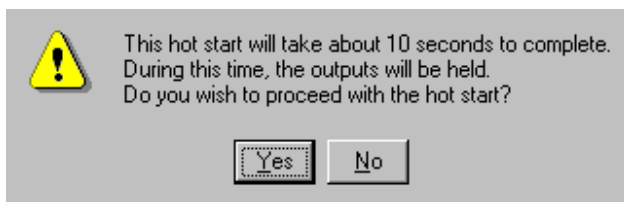

If this time period is acceptable, click Yes to begin the Hot Start. If this time period is not acceptable, press No.

### Configuration Parameters

**All Configuration Parameters are set to the value or state in the .cde file following a download.** For example: *Tuning constants could be over written by a Download while in Run Mode.* The tuning constants are considered **part of the configuration**. If you DO NOT first upload the present configuration, you will overwrite the active parameters with the values in the configuration that are downloaded. The new download is an all or nothing proposition.

### Data Storage Schedule

Assuming changes have NOT been made to an OI data Storage Schedule, the data storage will be interrupted only as long as it takes to transfer the configuration changes.

## Download Controller Firmware

### Background

Code download provides a mechanism to upgrade the firmware in your HC900 Hybrid Controller to a newer version without the need to replace the CPU card. This can be useful if you wish to upgrade your controller to take advantage of new features and functions as they are introduced, or in the event that a software bug requires field repair.

### Getting Started

Before you begin the download there are a few things you need to be aware of.

- Code Download can take from a couple of minutes using Ethernet to over one hour if using a Modem. Therefore, it is highly recommended that you do not start the code download procedure at a time when the likelihood of power failure is increased, such as during thunderstorms.
- The code download function is only available through the HC900 Hybrid Control Utilities program connected to the controller via the CONFIGURATION port or Ethernet port on the HC900. Use the Utilities Worksheet to do the download.
- The controller will not allow the controller firmware download to begin if the battery is bad.
- Code download will destroy the configuration database in the controller. Therefore, before code download is started, either upload the configuration file via the operator interface and save on floppy, or upload and save to your PC via the software's Utilities Worksheet.

### Controller Firmware Files

Install these three files in the same directory:

Controller File    *Version of file .CPU*  
Scanner File      *Version of file .SCN*  
Loader File       *Loader.S19*



To obtain these files, go to <http://content.honeywell.com/ipc/faq>, Modular Control Systems, HC900. Version 1.03 or later must be used. It is recommended that both the controller and scanners be upgraded together.

### Controller Mode

Before starting the Controller Firmware Download, switch the controller to "Program Locked" or "Program" mode. Program Locked offers more security by requiring a key to change the mode switch position. See set controller mode.

### Download Procedure

Step	Action
1	Backup the controller configuration either by uploading to floppy disk on the operator interface, or uploading and saving via the Hybrid Control Utilities.

Step	Action
2	Make sure the controller's mode switch is in "Program" (locked) or "Run/Prog" position. If the switch is in "Run/Prog" position, go to set controller mode display and change mode to Program.
3	In Hybrid Control Utilities select the Utilities Worksheet tab.
<b>Controller Module</b>	
4	From the "Controller Utilities Functions" select "Download to Controller".  On the sub-menu, select "Controller Firmware", then " <b>Controller Module</b> ".
5	Use the "Look in:" drop down list in the "Open" dialog box to select the drive and folder you placed the files in.
6	Select and open the file " <b>Version.CPU</b> " displayed in the file list box.
7	Select the "Port" and "Address" on the "Download File" dialog box.
8	Click on the "Start" button in the "Download File" dialog box. The download will start, and progress is displayed. The download itself will take a few minutes, depending on the Port type and connection.
9	A "Download Succeeded" status will be displayed in the "Download File" dialog box.  If a failure is detected, an error message will appear in the Status section of the "Download File" dialog box. See " <a href="#">Error Messages</a> " for a list of possible messages and resolutions. Also see <a href="#">Failure Modes</a> .
<b>Scanner Module</b>	
10	From the "Controller Utilities Functions" select "Download to Controller".  On the sub-menu, select "Controller Firmware", then " <b>Scanner Module</b> ".
11	Use the "Look in:" drop down list in the "Open" dialog box to select the drive and folder you placed the files in.
12	Select and open the file " <b>Version.SCN</b> " displayed in the file list box.
13	Select the "Port" and "Address" on the "Download File" dialog box.
14	Click on the "Start" button in the "Download File" dialog box. The download will start, and progress is displayed. The download itself will take a few minutes, depending on the Port type and connection.
15	A "Download Succeeded" status will be displayed in the "Download File" dialog box.  If a failure is detected, an error message will appear in the Status section of the "Download File" dialog box. See " <a href="#">Error Messages</a> " for a list of possible messages and resolutions. Also see <a href="#">Failure Modes</a> .
16	Restore the configuration from the backup copy you previously made.

### Failure Modes

If there is a download failure indication on the "Download File" dialog box:

- DO NOT cycle the controller power and DO NOT remove the battery.
- Check the physical connections.
- Check for power failures.
- Restart the download from the beginning.

## Download Firmware Error Messages

This is a list of possible error messages that could be displayed as the result of a Download Firmware failure:

Error Message	What to do
<b>Instrument must be in PROGRAM LOCK mode to perform this operation</b>	Put controller in program lock mode before starting code download.
<b>Instrument's battery missing or dead</b>	Replace controller battery before starting code download.
<b>Missing loader binary file</b>	Could not open the loader file. Make sure the "loader.s19" file is in the same directory as the firmware file to be downloaded.
<b>Could not open firmware update file</b>	Make sure the firmware file is present in the directory selected.
<b>Programming is not required, the downloaded version matches the code in the controller</b>	The version in the controller matches the version that was downloaded.
<b>The downloaded file is corrupted</b>	The firmware file was bad. Replace the firmware file
<b>Failed to complete file transfer</b>	Could be caused by communication loss or controller power failure. Restart code download again.
<b>Controller is not responding, code download failed</b>	Could be caused by communication loss or controller power failure. Restart code download again.
<b>Failed to put instrument into loader transfer mode</b>	Could be caused by communication loss or controller power failure. Restart code download again.
<b>Failed to get controller status</b>	Could be caused by communication loss or controller power failure. Restart code download again.

Error Message	What to do
<b>Unexpected controller mode. Code download will abort. The controller will now reset</b>	Could be caused by communication loss or controller power failure. Restart code download again.
<b>Failed to get expansion rack status</b>	Could be caused by communication loss or controller power failure. Restart code download again.
<b>FLASH erase failure. Replace the controller card</b>	The controller has a hardware problem. Replace the controller card.
<b>FLASH programming failure. Replace the controller card</b>	The controller has a hardware problem. Replace the controller card.
<b>FLASH memory failure. Replace the Controller card</b>	The controller has a hardware problem. Replace the controller card.
<b>An incomplete code download has been detected. Do not remove controller power! Removing controller power could result in damage to the scanner card(s)</b>	A previous code download was aborted or failed. Code download will proceed using the selected file.
<b>An incomplete code download has been detected. Code download will proceed using the selected file</b>	A previous code download was aborted or failed. Code download will proceed using the selected file.
<b>No scanner racks detected</b>	Most likely cause is no expansion racks connected to the main controller. It can also be caused by a failed scanner card. If a scanner is properly connected to the controller and this message is displayed, replace the scanner card.
<b>"Rack 1: SUCCESS, Rack 2: FAILED"</b>	Completion report for scanner code download. There should be a SUCCESS status for each card connected to the main controller rack. A FAILED status could be caused by a communications problem between the main controller rack and the scanner racks or by a failed scanner card. Restart code download again.

## File Properties

Lets you view the title and author of the file as well as view the file statistics (Number of Blocks, Inputs, and other items).

From the Hybrid Control Utilities Window File menu, select "Properties". Or in the File Browser Window right-click on an open configuration.

The "File Properties" dialog box will appear.

Select a tab:

### General

Title and Author.

Read only: Path and file name, Date created and Last Modified, Schema #, Device information (CPU type, Revision number)

### Statistics

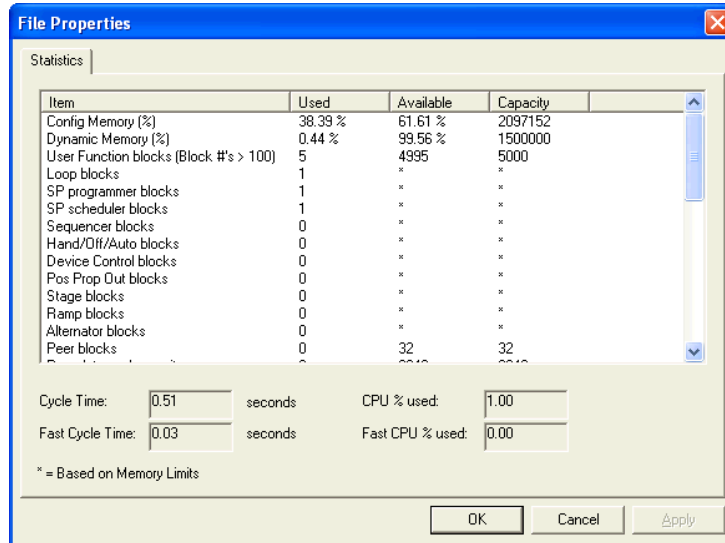

Shows usages and capacities for all items in the configuration. Asterisk \* indicates there is no specific limit for this item, its limit is determined by available memory.

Cycle Time and Fast Cycle Time increase (slow down) as the following increase: CPU % Used, Fast CPU % Used, Dynamic Memory, Config Memory. Also, extensive use of Free Form Logic blocks (as opposed to equivalent gate logic) can substantially increase Fast Cycle Time.

Be aware that deleted function blocks consume memory; this memory can be made available by defragmenting.

"Read Protection" - Indicates current protection.

"Worksheet Protection" - Indicates current protection.

## File Read Protection

Protected files are password protected. You will be prompted for a password to open them.

## Write Protect a File

### Introduction

Optional configuration File Write protection is provided. This feature makes use of the disk general file "Read Only" attribute. All the files default to "No Protection". When set to "Read Only", the file is Write Protected, which means it cannot be over written or deleted.

Select "Write Protect File" from the FILE menu.

Use the Check Box on the dialog box that appears to turn the attribute On (selected) or Off (deselected).

## PC Comm Ports and Connections

### How to Manage PC Comm Ports and Connections

The middle and lower portions of the Utilities Worksheet contain the PC Comm Ports and Connections functions.

Setting up your PC Comm Ports consists of the following functions:

- PC Network Port Setup
- PC Serial Comm Port Setup
- PC to Controller Connection Settings
- Remote Loopback test
- Remote Access
- Communications Statistics

### PC Network Port Set Up For Controller Access

The software lets you setup a PC Network Port and up to 8 PC Serial Comm ports for interface to a specific controller (serially via the controller's RS-232 configuration port or over a network via the controller's Ethernet port, accessed by its IP address). You will need an Network Interface Card (NIC) in your PC for network connection. If there is a Modem on your PC, a symbol will appear on one of the Serial comm ports buttons.

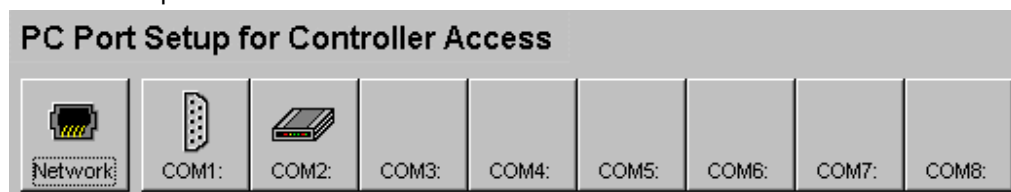

#### Setting Up a Network Port

Click on the Network Port setup button



The Network Port Dialog Box will Open

##### To ADD a Network Port:

Click on ADD and enter the properties in the Device IP Address fields.

##### To EDIT a Network Port:

Click a device, click on EDIT and enter the properties in the Device IP Address fields.

##### To Delete a Network address:

Click on a device in the Network address list, then click Delete button. The address will be deleted.

##### To do a Loopback test for a specific address

Click on the Loopback button.

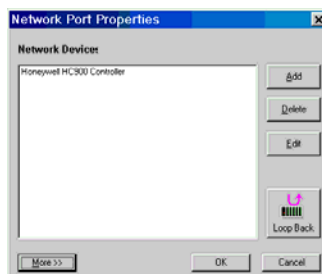

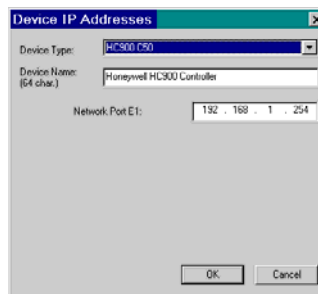

For **Advanced Network Setup**, click on the MORE>> button at the bottom of the "Network Port Properties" dialog box.

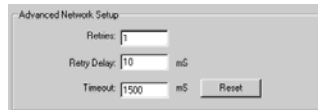

*Number of Retries before Abort* - Enter a decimal value

*Retry Delay* - Enter a value in milliseconds

*Timeout* - Enter a value in milliseconds



*Note: It is not recommended that you set the values lower than those shown in the dialog box, since it may cause some communications operations to fail.*

Press **Reset** button to reset these fields to their default values

## PC Serial Com Port Setup

The software lets you setup a Network Port and up to 8 Serial Comm ports. If there is a Modem on your PC, a symbol will appear on one of the Serial Comm Ports buttons. See Setting up a Serial Com Port with a Modem.

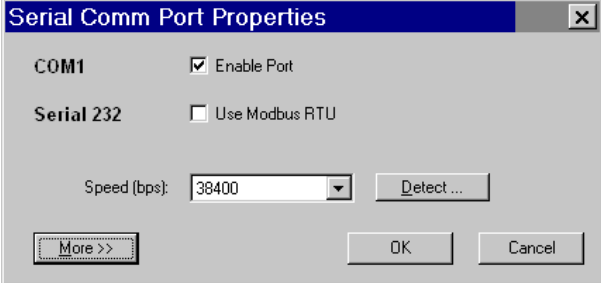
### Setting Up a Serial Comm Port

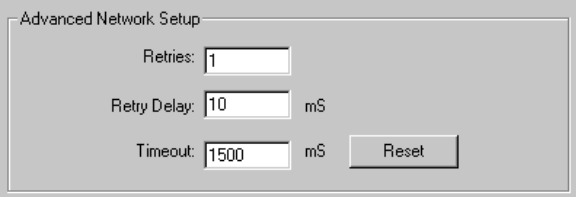
<p>1. Click on the Serial Comm Port setup button. When there is no port icon above the comm port name, the port is currently disabled.</p>	
<p>2. The "Serial Comm Port Properties" Dialog Box will Open</p> <p>Click the 'Enable Port' box</p> <p>Manually select a Baud Rate from the "Speed" drop-down menu, or if a controller is currently connected to the ports, press the "Detect" button to detect the controller's RS232 baud rate.</p> <p>Click OK.</p> <p>Note: The controller's serial port can be set for either RS232 or RS485 operation (by means of DIP switches on the CPU card). If the Detect process runs through all of the baud rates rapidly without appearing to actually check each baud rate, there may be a mismatch between the PC's serial port type and the controller's serial port type. If this behavior occurs, make sure that the DIP switches on the controller's CPU card are set correctly. The factory settings are RS232 for Serial Port S1 and RS485 for Serial Port S2.</p>	 <p>Note: The serial comm ports are configured to default to Honeywell ELN protocol, If a user configures a serial port to use Modbus RTU (slave) protocol, the Serial 232 box may be checked for HC Designer to communicate via this protocol.</p>
<p>3. The Serial CommPort Button will now show an icon indicating that the port has been set up.</p>	
<p>4. For <b>Advanced Network Setup</b>, click on the MORE&gt;&gt; button at the bottom of the "Serial Comm Port Properties" dialog box.</p> <p><i>Number of Retries before Abort</i> - Enter a decimal value</p> <p><i>Retry Delay</i> - Enter a value in milliseconds</p> <p><i>Timeout</i> - Enter a value in milliseconds</p> <p><i>Note: It is not recommended that you set the values lower than those shown in the dialog box, since it may cause some communications operations to fail.</i></p> <p>Press <b>Reset</b> button to reset these fields to their default values.</p>	

### Setting Up a Serial Comm Port with a Modem

Modems must be "Installed" in MS Windows.

Click on the Serial Comm Port Setup button that contains an image of a Modem



The "Serial Comm Port Properties" Dialog Box will Open

Click the 'Enable Port' box

There is NO Baud selection because the speed is determined by the controller's modem.

Click OK,

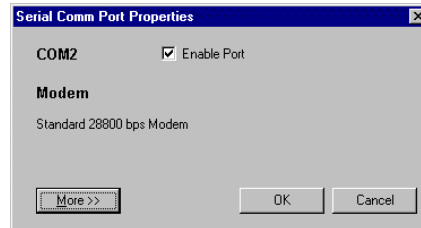

For **Advanced Network Setup**, click on the MORE>> button at the bottom of the "Serial Comm Port Properties" dialog box.

*Number of Retries before Abort* - Enter a decimal value

*Retry Delay* - Enter a value in milliseconds

*Timeout* - Enter a value in milliseconds

*Note: It is not recommended that you set the values lower than those shown in the dialog box, since it may cause some communications operations to fail.*

Press **Reset** button to reset these fields to their default values.

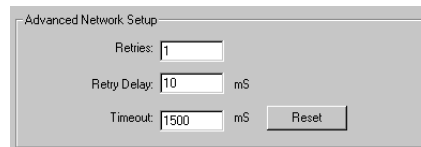

For **Telephony Settings**, click on the MORE>> button at the bottom of the "Serial Comm Port Properties" dialog box.

**Click on a radio button to select one of the following two options:**

*No Timeout* - No timeout is performed and the application will stay connected until you Hang Up

*Connection Timeout* - Enter in the active field (in minutes) how long the application will leave the line open before hanging up automatically.

The Modem will hang up if there is no communications activity for this amount of time.

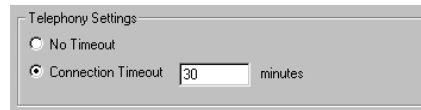

## PC to Controller Connection Settings

After setting up your PC Network and PC Serial Comm Ports:

Select a Port from the drop-down menu

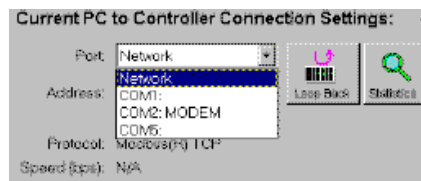

If you selected "Network" Select the Address of the controller from the drop-down menu.

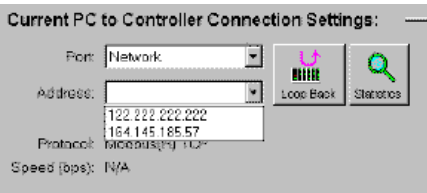

You can run a loopback test

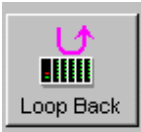

You can view and reset the communications statistics



## Remote Loopback Test

Remote Loopback tests the connection between the PC and the Controller.

### Running the test

Click on the Loopback icon on the Utilities Worksheet Window. . The "Remote Loopback Test" dialog box will appear.

Click "SEND". The Status line will read:  
***Instrument Responded Correctly***, or  
***Instrument did not Respond*** - check the connections

Click "Close".

## Remote Access

### Overview

The Hybrid Control Utilities software supports Remote Controller Access via dial-up modem. An external modem is required at the controller and is connected to the standard RS 232 configuration port.

If a modem is already installed on the PC the Hybrid Control Utilities will notify you that it exists.

Remote Access functions include on-line monitoring Live Monitor - Overview, Uploading and Downloading Configurations.

### Procedure

Click on the Utilities tab.

Click on a Comm Port, under PC Port Setup, that indicates a Modem.



The Serial Comm Port Properties dialog box opens,  
Click on the "Enable Port" box.

From the "Port" drop-down menu, select "COMx:MODEM".



will appear next to the Statistics button.

Click on this icon and the "Select the Number To Call" will appear.

To **Hang Up** a call, select "**Hangup Modem**" from the File Menu in the Main Menu. A message will ask you to confirm that you want to hang up.

## Communications Statistics

The "Statistics" button on the "Current PC to Controller Connections Settings" will launch the "Communications Error Summary" dialog box. The summary statistics are shown below:

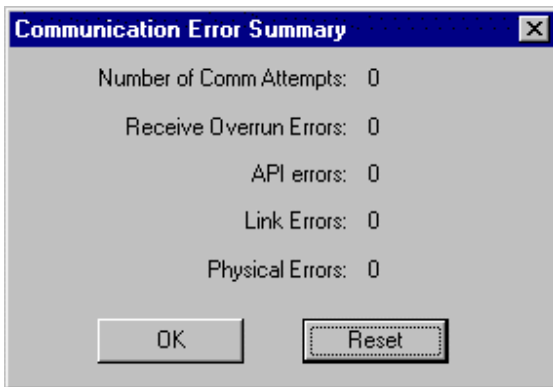

See the table below for corrective action for each communication error. Click on "Reset" to change the statistics to "0".

Error	Reason
Number of Comm Attempts	Count of messages sent down to a Controller
Receive Overrun Errors	A count of Controller response messages that were longer than expected. Make sure you have the latest version of HC Utilities and that it is compatible with the Controller version. Contact Technical Support if the problem continues.
API Errors	<p>The number of Application Errors are typically errors reported by the Controller.</p> <p>Common reasons for this error:</p> <p>Instrument responded to the wrong message. Check that there isn't more than one device with the same IP or Modbus address trying to communicate with the Controller.</p> <p>Controller communication port is in use by other device(s).</p> <p>Instrument responded with an error code. Take note of any error message dialog boxes that may popup while communicating with the Controller (e.g. While Monitoring). Attempt any corrective action based on the reported errors.</p> <p>Contact Technical Support if the problem continues.</p>
Link Errors	Count of messages that could not be interpreted by HC Utilities. Typically these occur when the response message contains garbled data. Check physical connections between the Controller and the PC. If you are using a modem or a serial cable, this error may be the result of "line noise".

---

Physical Errors	Count of hardware type errors. These typically occur when the Controller doesn't respond. Check cable and other hardware connections. If using a modem or a serial cable, verify the cable connections and baud rates of all pieces.
-----------------	--



## Worksheets Overview

### What is a Worksheet?

A Worksheet is a logical partition of a configuration. A configuration is built using three main Worksheet types.

They are organized by type.

- Controller Worksheet ( 1 per configuration)

- Operator Panel Worksheet ( 1 per configuration)

- Function Block Diagram Worksheet - FBD ( up to 20 per configuration)

- Modbus Map Worksheet – (1 per configuration. Visible only when using a Custom Modbus map)

In addition, a Utilities Worksheet is available to provide a set of maintenance functions for the controller.

Each Worksheet may have full or restricted access (Worksheet Protection).

## Worksheet Category Tabs

A configuration is organized into categories shown as tabs at the bottom of the Main window:

- Controller
- Display
- Function Blocks
- Modbus Map Worksheet – (1 per configuration. Visible only when using a Custom Modbus map)

An additional tab, Utilities, is provided access to a variety of useful functions that interact with the controller.



## Controller Worksheet

### Controller Worksheet Overview

There is one worksheet for the configuration. It displays the I/O in all configured racks.

#### Toolbar

The Controller Worksheet has a Toolbar to launch dialog boxes to configure:

**Print Worksheet**- Prints the I/O Summary as viewed on the worksheet.

**Controller Identification** - Shows the **controller name**. It will be displayed on the Operator Interface used for Peer Communications (16 characters).

**Controller E-Mail Notification**

**Unlock Worksheets**

#### I/O Summary



A summary of each addressed I/O point (as well as unassigned I/O points) in the configuration indicates:

- Rack/Module/Channel
- Block ID - a hot link when clicked finds the I/O block on the Function Block Diagram
- Engineering Units and AI Input range
- Signal Tag of primary output pin (if present) a hot link when clicked finds the signal tag on the Function Block Diagram
- Signal Descriptor of primary output pin (if present)

This assignment summary is built and updated dynamically on the worksheet body. It can be printed from the toolbar icon.

### Controller Configuration Toolbar

Click on **ICON** to open a dialog box.

ICON	Function	Dialog Box Comments
	<b>Print Worksheet</b>	Click to open the standard <b>Print</b> dialog box.  Fill in appropriate fields  Printed Output is the I/O Summary as viewed on the worksheet.  To display each page, as it will look when printed, click Print Report Preview on the File menu.
	<b>Controller Identification</b>	Click to open the <b>Controller Identification</b> dialog box.  Also indicates controller type and revision. (read only)
	<b>E-Mail Notification</b>	Click to open the <b>E-Mail Notification</b> dialog box.  Two Tabs on Dialog Box:  <b>General</b> - FROM name displayed for convenience (read only) and SUBJECT information - 31 character configurable text.

		<p><b>To List</b> - up to 3 configurable E-Mail addresses. For each Email address check an Alarm/Event priority</p> <p>See "<a href="#">E-Mail Notification</a>"</p>
	<p><b>Unlock Worksheets</b></p>	<p>Click to open the "<a href="#">Unlock Worksheets</a>" dialog box. Enter a password and click "Unlock" to unlock all worksheets.</p>

## E-Mail Notification



opens the **E-Mail Notification** dialog box. It lets you view up to three E-Mail addresses per controller configuration for Alarm and Event notification.

There are two tabs on the dialog Box.

### General Tab

**FROM** The **Controller name** is configured by the builder of the Configuration file [Read Only]

**SUBJECT** Event Subject (up to 31 characters)  
Alarm Subject (up to 31 characters)

### To List Tab -

3 configurable E-Mail addresses.(32 characters per addresses)

Each Email address has checked the Alarm/Event priorities you want the E-mail address to receive.

Events do not have multiple priorities like alarms because they are considered at a priority lower than all alarms.

**Alarm priorities** were set during "[Alarm Group Configuration](#)" under "[Alarm Details](#)"

- 2 = Low Priority Alarm
- 3 = Medium Priority Alarm
- 4 = High Priority Alarms
- 5 = Emergency Alarm

The priority of an event is always indicated as "1" - (see [Event Configuration](#))

**Attention: See "[Set Controller Network Parameters](#)" and follow the wizard to set up a SMTP mail server IP Address.**

### Examples:

[Somebody@somewhere.com](#) receives **only priority 5 Alarms**  
(only the check box for "5" is checked)

[Aperson@somewhere.com](#) receives **all Alarms and Events**  
(all 5 boxes are checked)

[People@somewhere.com](#) receives **only Events**  
(only check box for "1" is checked)

## Unlock the Worksheets



opens the "Unlock Worksheets" dialog box.

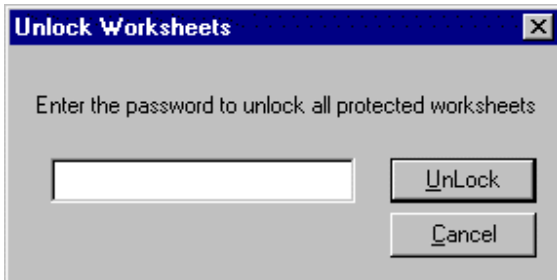

Enter the password in the field and then, press "UNLOCK".  
How to add/change worksheet protection.



## Data Storage

**Note:** This section does not apply to the 900 Control Station.

### Data Storage Overview

The Data Storage feature provides background storage of process information on a storage device for analysis by an off-line computer equipped with Honeywell data analysis software.

Data stored files can not be reviewed from the operator interface. The instrument can support both continuous and discontinuous (batching) modes of the following storage types:

**Trends** - Two Trend groups of up to 12 points each can be stored. Floppy disk capacity for trends is inversely proportional to the number of trend points and the storage time interval (that is, the time between trend samples). For example, when storing 2 trend groups of 12 points each at a storage interval of 2 seconds, the storage device will be filled in a few hours. Conversely, when storing 1 trend group of 3 points at a storage interval of 30 minutes, the storage device could take several months to be filled.

**Point Log** (unit data samples) - A point log file to take a "snapshot" of process data for up to 12 points is also provided. Point log samples can be scheduled to occur at a user-specified time synchronized to the controller's Real Time Clock (RTC) or by a digital event in the controller. The maximum sample rate for point log data is 60 seconds per sample. The Point log file has a maximum capacity of between 2000 and 5000 records per file.

**Alarms** - Alarm recording is available to store on and off alarm actions. Alarm data includes the point tag, a 16-character point description, and the time and date of alarm occurrence. The Alarm file has a capacity of between 150 and 1500 records per file.

**Events** - Digital event recording is also available to store on and off transitions of digital events in the controller. Event data includes the point tag, a 16-character point description, and the time and date of event occurrence. An Event file has a capacity of between 150 and 1500 records per file.

**Setpoint Programs/Schedules, instrument configurations, recipes, variables, diagnostics, and calibrations are not part of the Data Storage feature.**

### Associated Information

Data Storage Conventions  
Data Storage Enable Conditions  
Data Storage Configuration

## Data Storage Conventions

### Storage Modes

Trends, Point Log, and Alarms/Events can be stored in **Continuous** or **Batch** modes. In addition, Point Log can be stored in **On Command** mode.

Mode	Description
<b>Off</b>	No data will be collected
<b>Continuous</b>	Data is sampled at the storage interval
<b>Batch</b>	Data is sampled at the storage interval, but also a Batch Enable Signal separates the sampled data into numbered batches. Batch #1 begins when the Batch Enable Signal turns on, and ends when the signal turns off. Batch #2 begins when the Batch Enable Signal turns on, and ends when the signal turns off, etc. No batch mode data is collected while the Batch Enable Signal is off. The Batch Enable Signal does not affect data being stored as Continuous or On Command.
<b>On Command</b>	Point Log data is sampled on each off-to-on transition of the Point Log Enable Signal.

### Storage intervals

When data storage is enabled, samples are taken at regular intervals known as the storage intervals. These intervals can be from a few seconds to 30 minutes. Each data type has its own storage interval. For example:

**Trends** can be stored using one interval (like 5 seconds),

**Point Log** using another interval (like 10 per day), and

**Alarms/Events** (stored as they occur).

Or, they can **all use the same interval**. It depends on how data storage has been configured.

In **Continuous** and **Batch** modes, the storage interval determines how often data is sampled and stored:

For **trends**, data is first sampled when storage is enabled and again at equally spaced intervals thereafter. For example, if trend storage is enabled at 2:03 p.m. and the interval is 10 minutes, trend storage occurs at 2:03, 2:13, 2:23, etc. until storage is disabled.

For **Point Log**, data is first sampled after storage is enabled but not until the programmed Start Time. Data is sampled at equally spaced intervals after the Start Time. For example, suppose the Start Time is 3:00 p.m. and the storage interval is 10 minutes. If storage is enabled at 2:03 p.m., the first sample will occur at 3:00 and every 10 minutes thereafter. If storage is disabled at 3:35 and enabled at 3:42, storage will resume at 3:50. Notice that the interval is synchronized to the Start Time.

**Alarm/Events** are logged on occurrence with time and date (No interval)

In **On Command mode for Point Log**, there is no storage interval or Start Time. A single sample of Point Log data is taken when the Point Log Enable changes from off (disable) to on (enable).

### How Storage is Enabled

Data collection may be started through key actions from the operator interface keyboard or from digital status signals from the controller. An "S" in the status line of the operator interface display indicates active storage. *[For detailed information refer to Data Storage Enable Conditions]*

### Disk Capacity

The disk capacity (in time) is calculated and displayed once all storage initialization is complete. This eliminates the need for manual calculations and gives the operator the exact duration of the disk. All file types in the data storage feature may be configured to stop collecting data when the file is full or to continue in a circular storage mode (roll-over) where the oldest data is discarded as new data is collected. When roll-over is **not** selected, a disk full warning indication is provided in the status line of the display. The configurator, as required, may change the percent full limit. A storage buffer in the operator interface allows changing the disk media without the loss of process data.

**Calculation for Data Storage Capacity**

$$\text{Trend Capacity (In Hours)} = \frac{\text{Disk factor} * (R1)}{F1 + (F2 * (R1/R2))}$$

Where:

R1 and R2 are the storage rates (in seconds) for Trend 1 and Trend 2, respectively.

F1 and F2 are the point factors associated with the number of points per trend file.

Disk Factors:

398	Trends files only active
394	Trends files + Alarms and Events
347	Trend files, + alarms and Events + Point Log Files

Number of points in trend

1	2	3	4	5	6	7	8	9	10	11	12
14.00	20.16	26.53	33.60	38.77	45.82	50.40	56.00	63.00	72.00	84.00	84.00

Point Factor (F1 and F2)

**File Extensions**

The following File Extensions are used for the HC900 Controller's Data Storage output files:

LNT for **Trend** Files

LNP for **Point Log** Files

LNA for **Alarm** Files

LNE for **Event** Files

## Data Storage Enable Conditions

### How storage is enabled

Data Storage Enable/disable is an Operator Interface function. If a schedule is developed in the software, all storage is automatically enabled.

#### Enable controls

The figure below shows the controls that must be enabled for each storage mode and data type. The left side shows the three data types and their possible storage modes (only one storage mode is in effect for any data type). The arrows show the conditions required for that storage to take place.

For example, trend batch storage requires:

the Trend Storage Control to be on (enabled at configuration – if any signal is selected for storage i.e. Signal Enable = NONE),

the Batch Command Control to be on (enabled at configuration), and

the Data Storage Control to be enabled (enabled at Operator Interface).

Notice that the Batch Command Control applies only to batch storage mode.

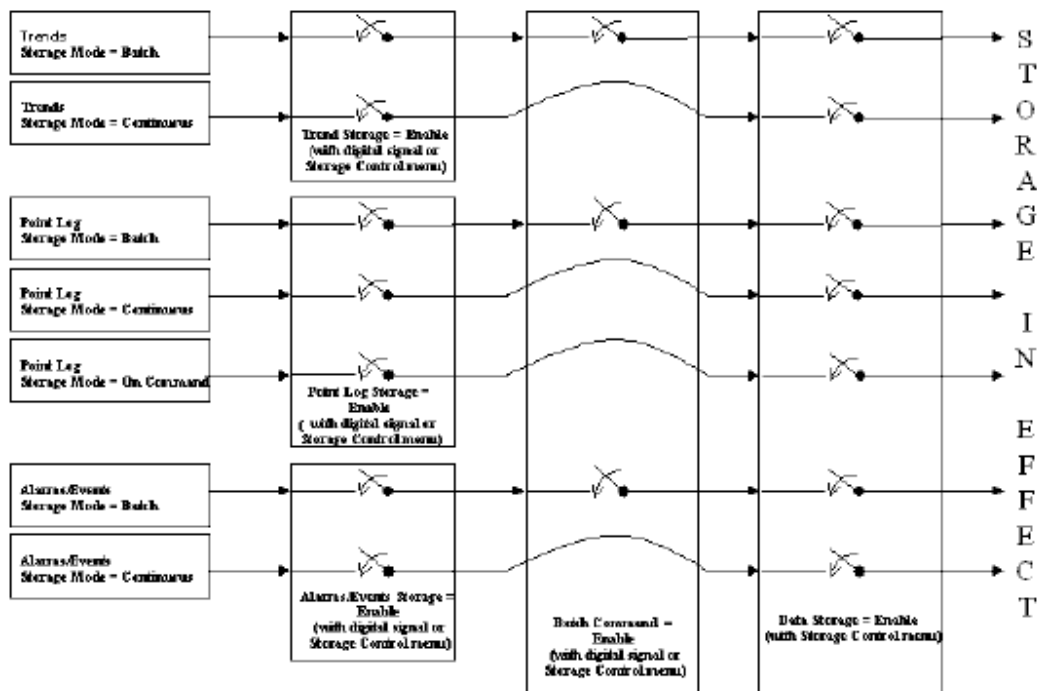

### Three Levels of Enabling

There are three levels of Data Storage Enable:

Data Storage Disable Signal (Operator Interface) – See Note 1.

Data Type Enable Signals

Batch Command Enable Signal

Note 1. Since any storage schedules loaded into the system automatically enables storage, the operator interface can disable storage.

### **Data Type Enable Signals**

This level of control is the Data Type Enable Signal. Each data type (trends, point log, and alarms/events) has its own Enable Signal that can either be configured as a digital signal on the Hybrid Control Designer, or if not configured as a digital signal (NONE selected on Hybrid Control Designer Data Storage Configuration), it will appear on the Storage Control menu on the operator interface

For example, if the Trend Enable Signal is *configured as a digital signal in the Hybrid Control Designer Data Storage Configuration*, it will **not** appear on the Storage Control menu on the operator interface. This is done to avoid having two conflicting sources for the enable signal.

When a *digital signal is not used*, the Trend enable signal is set to enable when the configuration is loaded. The Trends can then be disabled from the Operator Interface.

The Enable Signal has two functions for Point Log storage.

In Continuous and Batch modes, it enables Point Log storage to begin at the Start Time and at every storage interval thereafter.

In On Command mode, when it changes from off (disable) to on (enable), it causes a single sample of Point Log data to be stored at that moment. (*See Point Log Storage Enable Conditions*)

### **Batch Command Enable Signal**

This level of control is the Batch Command. It is a single control signal that starts and stops storage for all data types configured for batch storage.

**It does not affect Continuous or On Command storage.**

If the Batch Signal is *configured as a digital signal in the Hybrid Control Designer Data Storage Configuration*, it will **not** appear on the Storage Control menu on the Operator Interface. This is done to avoid having two conflicting sources for the signal.

When a *digital signal is not used* and Batch storage has been selected, the Batch command signal is set to Stop. Batches can be started from the Operator Interface.

## **Storage Enable Conditions**

### **Trend Storage Enable Conditions**

The figure below shows examples of Trend Storage Enable Conditions.

Notice that **Continuous Trend** storage occurs unless **Trend Disable** or **Data Storage Disable** is selected.

For **Batch Trend** storage, notice that Trend enable/disable, Data Storage enable/disable must be set to enable and Batch command must be Start.

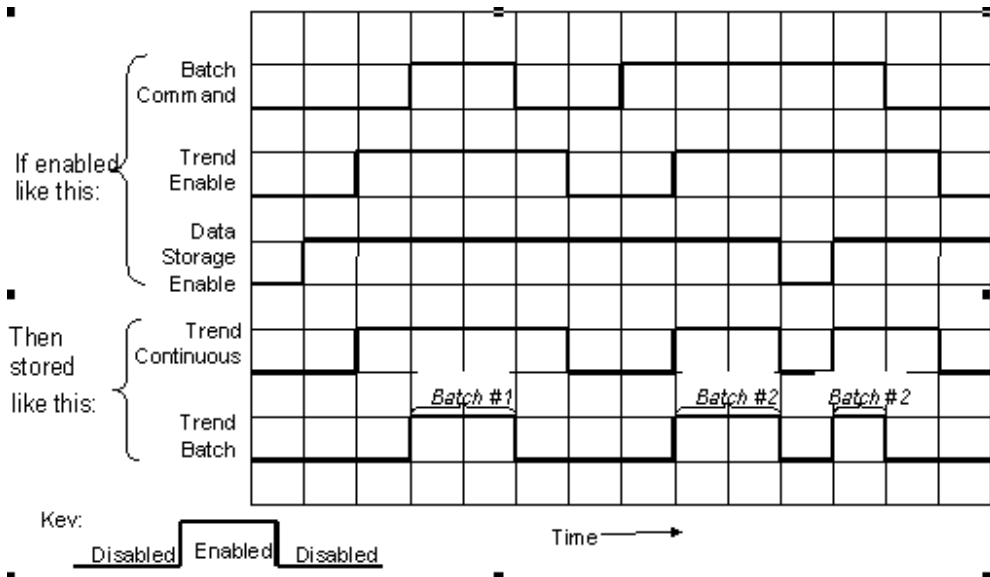

**Point Log Storage Enable Conditions**

The figure below shows examples of Point Log Storage Enable conditions.

Notice that it occurs unless **Point Log Disable** or **Data Storage Disable** is selected.

For **Batch Point Log** storage, notice that *all three enables must be on*.

The figure shows that storage does not actually occur until the Start Time occurs, and then at every Storage Interval thereafter.

For **On Command Point Log** storage, notice the samples are taken the instant Point Log Enable is enabled but not at intervals.

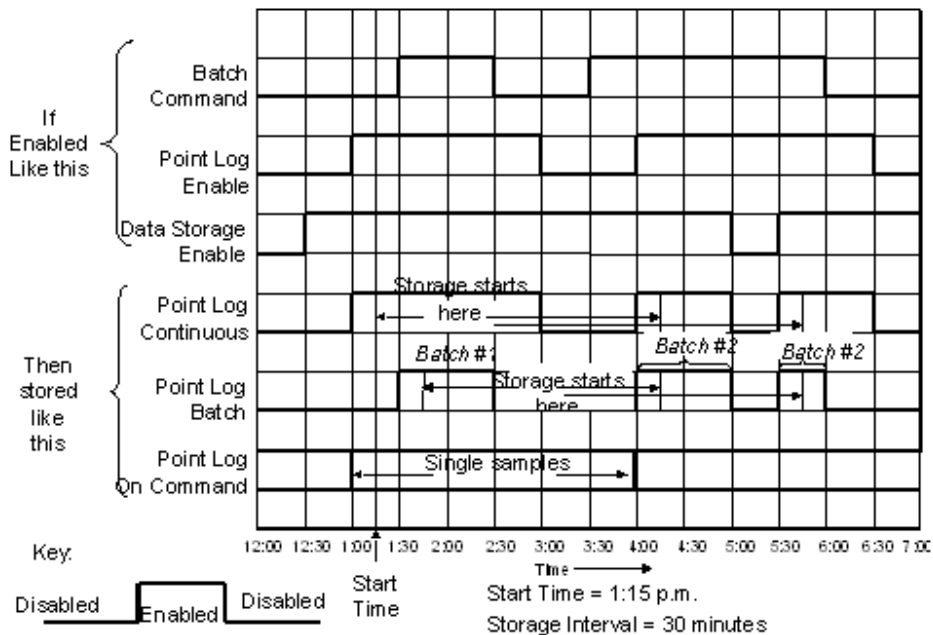

### Alarm/Event Storage Enable Conditions

The figure below shows examples of Alarm/Event Enable conditions.

Notice that **Continuous Alarm/Event** storage occurs unless **Alarm/Event Disable** and **Data Storage Disable** is selected.

For **Batch Alarm/Event** storage, *all three enables must be on*.

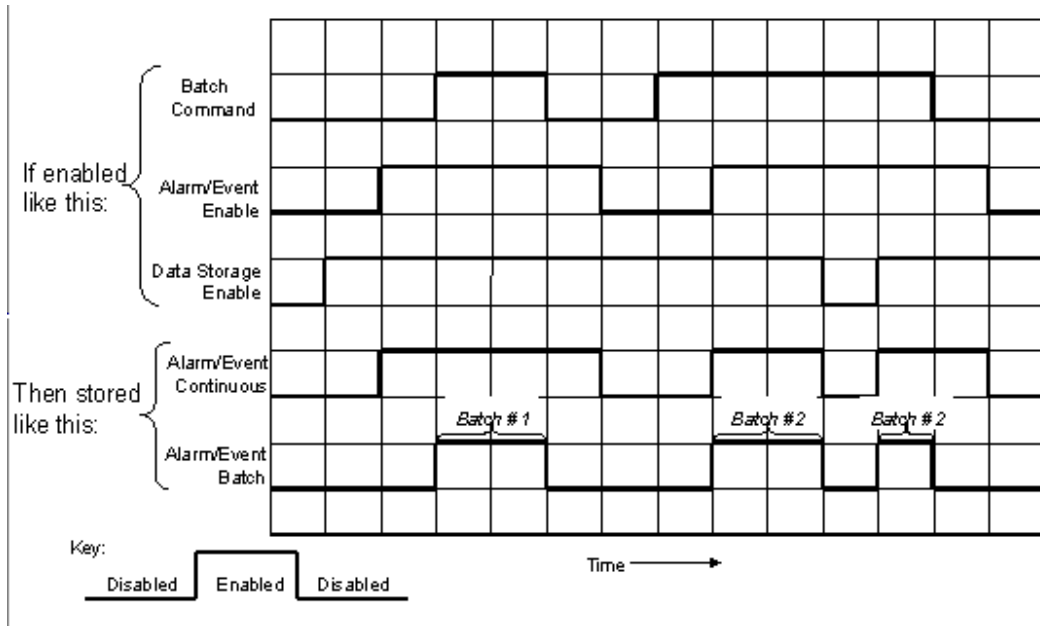

**1:** Although Alarm Storage is active during the specified time periods, Alarm records will only be saved on active transitions of the alarm status. If no alarm occurs during the active period, the data for that period will be blank.

## Data Storage Configuration Access



on the Operator Panel Worksheet Toolbar opens the **Data Storage Configuration** dialog box.

This facility allows you to view configured groups of data that will be stored to the Operator interface's data storage device. This process history can be a valuable source of information to analyze process operations quality and upsets.

The groups are configured in Hybrid Control Utilities and downloaded as part of the configuration.

You can also create a new data storage file (.dss) separate from the configuration. On the File menu, select New, Data Storage.

**Select a tab** at the top of the dialog box to access a specific Data Storage Configuration dialog box.

## Create/Edit Data Storage File

Creates/edits a data storage file (.DSS). File can be downloaded to the controller.

Step/Item	Action/Description
Select File, Open.	Lets you choose a .DSS file to edit. After selecting file the Data Storage Editor appears.
OR	
Select File, New.	"Choose a new file type" box appears.
Select Data Storage tab.	Data Storage button appears.
Select Data Storage.	The Data Storage Editor appears.
THEN	
Select a Reference Configuration.	A data storage file must have a configuration to give it context. Select an open configuration from the pull-down list. If none available, select Open Configuration to open one. The configuration will open. Click back to Data Storage Editor and select the reference configuration.
Trend	Trend setup.
Point Log	Point Log setup.
Alarm/Event	Alarms/Events setup.
Pre-initialize Disk	Prepares zip disk for data storage. Select this to avoid the long initialization time on the operator interface.
Print	Prints the data storage settings.

Step/Item	Action/Description
Save	Saves the data storage file as .DSS file.
Download	Downloads data storage file to the controller.

## Trend Storage Configuration

Trend storage will provide the following:

Number of Files:	2 maximum
Points per Trend:	12 maximum, Analog or Digital
Storage Modes:	Off, Batch, Continuous
Storage Interval:	2, 5, 10, 20,30,40, 50 seconds 1, 2, 5, 10, 20, 30 minutes
External Control:	Digital Tagged Signal – Start/Stop of both Trends

### Configuration Procedure

Select the "TREND" tab on the "Data Storage Editor" dialog box.

Active Field	Description
<b>Batch Enable Signal</b>	<p>This signal starts and stops storage for Trends configured for "Batch" storage. It does not affect "Continuous" storage selection.</p> <p>From the pull-down menu, select:</p> <p><b>NONE</b> – Batch is started/stopped only through the operator interface's Data Storage Control Menu (defaults to Stop on configuration download)</p> <p><b>ANY DIGITAL TAG</b> – Batch is started/stopped only through the on/off state of the selected Digital Signal. It <b>will not</b> appear on the operator interface's data Storage Control Menu</p> <p><i>For detailed information concerning Data Storage Enable, refer to "<a href="#">Data Storage Enable Conditions</a>"</i></p>
<b>Group</b>	Use the pull-down menu and select a Trend Group for configuration.
<b>Title</b>	<p>Enter a Group Title. There is a maximum of 24 characters</p> <p><i>(Note: This is not displayed on the Operator Interface. It only serves as a reminder for the user.)</i></p>
<b>File name</b>	Enter a File Name. There is a maximum of 8 Alpha Numeric characters. (DOS File Name restrictions)
<b>Tag List</b>	<p>From the Tag List drop-down menu, select the type of signals you want the tag list to display.</p> <p>Click on a Tag Name and click <b>ADD&gt;&gt;</b>.</p> <p>The tag name will be added to the "Selected Tags" list.</p>
<b>Selected Tag</b>	<b>Scaling Signals</b>

Data Storage  
Point Log Storage Configuration

Active Field	Description
<b>List</b>	Scale each tag selected for High and Low values for the Trend Display. Click on the "Scale High" and "Scale Low" fields and enter the value.  To delete a signal tag, click on a tag and click <b>Delete</b> .
<b>Storage Intervals</b>	<b>Storage Interval</b>  From the Storage Interval drop-down menu, select a storage interval of from 2 seconds to 30 minutes.  When Data Storage is enabled, samples will be taken at the interval selected here.  <i>Refer to Storage Intervals in Storage Conventions</i>
<b>Data Type Enable Signals</b>	This enable signal turns storage on and off for trends.  From the pull-down menu, select:  <b>NONE</b> – Trend Storage Enable is started/stopped only through the operator interface's Data Storage Control Menu (defaults to Enable on configuration download), or,  <b>ANY DIGITAL TAG</b> – Trend Storage is started/stopped only through the on/off state of the selected Digital Signal. It <b>will not</b> appear on the operator interface's data Storage Control Menu  <i>For detailed information concerning Trend Storage Enable, refer to "<a href="#">Trend Storage Enable Conditions</a>".</i>
<b>Storage Mode</b>	From the pull-down menu, select a Storage Mode.  Refer to " <a href="#">Data Storage Conventions</a> " for mode definitions.
<b>Rollover</b>	<b>Click</b> this box to allow data storage to continue collecting data in a circular storage mode where the oldest data is discarded as new data is collected.  <b>Clear</b> this box to allow data storage to stop collecting data when the file is full. You can configure a Warning Level for Disk Full %.
<b>Warning Level</b>	If you <b>do not select rollover</b> , enter a percent in the appropriate box.

## Point Log Storage Configuration

Point Log storage will provide the following:

Number of Files:	One
Points per File:	12 maximum, Analog or Digital
Storage Modes:	Off, Batch, Continuous, On Command
Storage Interval: (all relative to start time)	1 to 59 minutes, one minute increments 1 to 23 hours, one hour increments 1 to 30 days, one day increments Once month, same day of each month
External Control:	Digital Tagged signal - start/stop storage to file - On Demand sampling

### Configuration Procedure

Select the "**POINT LOG**" tab on the "Data Storage Editor" dialog box.

Active Field	Description
<b>Batch Enable Signal</b>	<p>This signal starts and stops storage for Point Logs configured for "Batch" storage. It does not affect "Continuous" or "On Command" storage selections.</p> <p>From the pull-down menu, select:</p> <p><b>NONE</b> – Batch is started/stopped only through the operator interface's Data Storage Control Menu (defaults to Stop on configuration download)</p> <p><b>ANY DIGITAL TAG</b> – Batch is started/stopped only through the on/off state of the selected Digital Signal. It <b>will not</b> appear on the operator interface's data Storage Control Menu</p> <p><i>For detailed information concerning Data Storage Enable, refer to "<a href="#">Data Storage Enable Conditions</a>"</i></p>
<b>File name</b>	<p>Enter a File Name. There is a maximum of 8 Alpha Numeric characters. (DOS File Name restrictions)</p>
<b>File Record Limit</b>	<p>Enter a File Record Limit number of between 2000 and 5000.</p>
<b>Tag List</b>	<p>From the Tag List drop-down menu, select the type of signals you want the tag list to display.</p> <p>Click on a Tag Name and click <b>ADD&gt;&gt;</b>.</p> <p>The tag name will be added to the "Selected Tags" list.</p>
<b>Selected Tag List</b>	<p><b>Scaling Signals</b></p> <p>Scale each tag selected for High and Low values for the Point Log Display. Click on the "Scale High" and "Scale Low" fields and enter the value.</p> <p>To delete a signal tag, click on a tag and click <b>Delete</b>.</p>
<b>Data Type Enable Signals</b>	<p>This enable signal turns storage on and off for Point Logs.</p> <p>From the pull-down menu, select:</p> <p><b>NONE</b> – Point Log Storage Enable is started/stopped only through the operator interface's Data Storage Control Menu (defaults to Enable on configuration download), or,</p> <p><b>ANY DIGITAL TAG</b> – Point Log Storage is started/stopped only through the on/off state of the selected Digital Signal. It <b>will not</b> appear on the operator interface's data Storage Control Menu</p> <p><i>For detailed information concerning Trend Storage Enable, refer to "<a href="#">Point Log Storage Enable Conditions</a>".</i></p>
<b>Storage Mode</b>	<p>From the pull-down menu, select a Storage Mode.</p> <p>Refer to "<a href="#">Data Storage Conventions</a>" for mode definitions.</p>
<b>Storage Interval</b>	<p>NOTE: <i>For On Command storage mode, there is no storage interval or start time. (They are not used.)</i></p> <p>Click on "Change". The "Storage Interval" dialog box will appear.</p> <p>Click on the radio button for Minutes, Hours, or Days and select a storage interval from the Edit box. Or, click on the radio button for "Once a Month".</p>

Data Storage  
 Point Log Storage Configuration

Active Field	Description
	<p>Click OK</p> <p><i>Refer to Storage Intervals in Storage Conventions</i></p>
<b>Start Time</b>	<p>NOTE: For On Command storage mode, there is no storage interval or start time. (They are not used.)</p> <p>Click on "Change". The "Change Time" dialog box will appear.</p> <p>In the Edit box in each field, select a start time.</p> <p>Click OK.</p> <p><i>Refer to Storage Intervals in Storage Conventions</i></p>
<b>Rollover</b>	<p><b>Click</b> this box to allow data storage to continue collecting data in a circular storage mode where the oldest data is discarded as new data is collected.</p> <p><b>Clear</b> this box to allow data storage to stop collecting data when the file is full. You can configure a Warning Level for Disk Full %.</p>
<b>Warning Level</b>	<p>If you <b>do not select rollover</b>, enter a percent in the appropriate box.</p>

## Alarm/Event Storage Configuration

Alarm/Event storage will provide the following:

Number of Files:	One each
Records per File:	150 to 1500 records per file
Data Types:	All Alarms – Time/Date, On/Off All Events – Time/Date, On/Off
Storage Modes:	Off, Batch, Continuous
External Control:	Digital Tagged Signal – Start/Stop storage to file

### Configuration Procedure

Select the "Alarm/Event" tab on the "Data Storage Editor" dialog box.

Active Field	Description
<b>Batch Enable Signal</b>	<p>This signal starts and stops storage for Alarm/Events configured for "Batch" storage. It does not affect "Continuous" storage selections.</p> <p>From the pull-down menu, select:</p> <p><b>NONE</b> – Batch is started/stopped only through the operator interface's Data Storage Control Menu (defaults to Stop on configuration download)</p> <p><b>ANY DIGITAL TAG</b> – Batch is started/stopped only through the on/off state of the selected Digital Signal. It <b>will not</b> appear on the operator interface's data Storage Control Menu</p> <p><i>For detailed information concerning Data Storage Enable, refer to "<a href="#">Data Storage Enable Conditions</a>"</i></p>
<b>Alarm File Name</b>	Enter a File Name. There is a maximum of 8 Alpha Numeric characters. (DOS File Name restrictions)
<b>Alarm File Record Limit</b>	Enter an Alarm File Record Limit number of from 150 to 1500.
<b>Event File Name</b>	Enter a File Name. There is a maximum of 8 characters
<b>Event File Record Limit</b>	Enter an Event File Record Limit number of from 150 to 1500.
<b>Data Type Enable Signal</b>	<p>This enable signal turns storage on and off for Alarm Events.</p> <p>From the pull-down menu, select:</p> <p><b>NONE</b> – Alarm/Event Storage Enable is started/stopped only through the operator interface's Data Storage Control Menu (defaults to Enable on configuration download), or,</p> <p><b>ANY DIGITAL TAG</b> – Alarm/Event Storage is started/stopped only through the on/off state of the selected Digital Signal. It <b>will not</b> appear on the operator interface's data Storage Control Menu</p> <p><i>For detailed information concerning Trend Storage Enable, to "<a href="#">Alarm/Event Storage Enable Conditions</a>"</i></p>
<b>Storage Mode</b>	<p>From the pull-down menu, select a Storage Mode.</p> <p>Refer to "<a href="#">Data Storage Conventions</a>" for mode definitions.</p>

Data Storage  
Alarm/Event Storage Configuration

---

<b>Rollover</b>	<b>Click</b> this box to allow data storage to continue collecting data in a circular storage mode where the oldest data is discarded as new data is collected.  <b>Clear</b> this box to allow data storage to stop collecting data when the file is full. You can configure a Warning Level for Disk Full %.
<b>Warning Level</b>	If you <b>do not select rollover</b> , enter a percent in the appropriate box.

## **Function Block Information**

### **Accessing Context Sensitive Help**

While in a Controller configuration, right click on a function block to access the block's Topic Help, Monitor functions, Cut, Copy, Paste functions and Properties Dialog Boxes.

### **Right Mouse Click**

See Right Mouse Click on page 26.



## Utilities Worksheet

### Utilities Worksheet Overview

This **Utility Worksheet** has three areas that let you perform a variety of tasks for maintaining the HC900 Hybrid Controller and setting up your PC's Communications Ports.

#### Controller Utility Functions

The upper part of the Utilities Worksheet contains the Controller Utility Functions. It has a list of icons that will launch dialog boxes for the following utilities:

Diagnostics  
Uploads  
Downloads (Configuration, Controller Firmware, Scanner Firmware)  
Set Controller Serial Port  
Calibrate Modules  
Set Controller Mode  
Set Controller's Network Parameters  
Set Controller Time  
Data Storage Utility  
Back Up Controller Information or Restore Controller Information  
Manually Write Database to Flash

#### Current PC to Controller Connection Settings

Displays Comm Port and Address information. Lets you select a Port and Controller Network Address from the drop-down menus.

Allows you to do a Loopback to check the communications connections.

Allows you to view and reset the communications statistics.

Allows you to Dial/hang up the modem.









#### PC Port Setup



Lets you set up a Network Port and up to 8 Comm Ports or Modems.

### Controller Utility Functions

The upper part of the Utilities Worksheet contains the Controller Utilities Functions. It has a list of icons that will launch dialog boxes for the following utilities:

ICON	FUNCTION	REFERENCE
	<b>Controller Diagnostics*</b>	Select from drop down menu: (options are only available in Monitor Mode) <b>Controller Diagnostics</b> <b>Rack Diagnostics</b> <b>Controller Ports Diagnostics</b> <b>Modbus Port Diagnostics</b> Modbus Master (Serial) Port Diagnostics Modbus/TCP Initiator Port Diagnostics <b>Forced Blocks</b> <b>Redundancy ...</b>

ICON	FUNCTION	REFERENCE
		Redundancy System Redundancy Link Lead CPU Reserve CPU Scanner 2 Link
	<b>Upload from Controller*</b>	Configuration Upload transfers a configuration <b>FROM</b> the controller <b>TO</b> the PC. See page 30.
	<b>Download to Controller*</b>	Downloads a saved configuration, controller firmware, or scanner firmware from <b>FROM</b> the PC <b>TO</b> the controller. See page 31.
	<b>Set Controller Port**</b>	Menu selection lets you: Set Protocol for controller's configuration ports
	<b>Calibrate Controller **</b>	Click to open the <b>Calibrate</b> dialog box. Four Tabs on the Dialog Box: <b>AI Channel</b> - see " <a href="#">Calibrate AI Channel</a> ". <b>CJ Temp</b> - see " <a href="#">Calibrate CJ Temp</a> ". <b>AO Channel</b> - see " <a href="#">Calibrate AO Channel</a> ". <b>PPO Block</b> – see " <a href="#">PPO Block Calibration</a> "
	<b>Set Controller Mode**</b>	Click to open the Set Controller Mode dialog box. Read the current mode, select a new mode, then write the new mode to the controller.
	<b>Set Controller Network Parameters*</b>	A Wizard interface guides you through connecting to a controller in order to view and edit the controller's network parameters In order to change the controller's network parameters, the controller must be in PROGRAM mode.
	<b>Set Controller Time**</b>	Click to open the Set Controller Time dialog box.
	<b>Data Storage Utility</b>	Click to open the Data Storage Utility dialog box. Select a Removable Disk Drive Group Number and Trend group number. Press "Initialize" to prepare the disk for storage.

ICON	FUNCTION	REFERENCE
	<b>Back Up Controller Information</b>	Backs up controller's configuration and port settings. See Back Up Controller Information.
	<b>Restore Controller Information</b>	This button visible for open backup files only. See Restore Controller Information .
	<b>Manually Write Database to Flash</b>	See Manually Write Database to Flash.

\* *These functions prompt you to select a PC port to which to connect.*

\*\* *These functions communicate to a controller by using the PC Port displayed in " Current PC to Controller Connection Settings".*

## Set Controller Serial Ports

Use this feature to set the RS232 and RS485 ports protocol.



has two tabs—Serial S1 (RS232) and Serial S2 (RS485)—each with the following settings.

**Honeywell ELN:** Default protocol

**Modbus RTU Master:** Select to set controller up as a master.

**Modbus RTU Master - Advanced:** Provides enhanced data throughput for applications where the HC900 is being used in conjunction with a "Modbus-to-fieldbus" gateway device. See page 72 for details.

**Modbus RTU Slave:** Select to set controller up as a slave.

**Slave Type:**

Multidrop--select when using more than one slave on the selected PC port.

Point to point--select for one slave

Modem--select when using a modem between the master and slave.

**Slave Address:** Enter 1-247, or 255.

**Modbus Slave Double Register Format:** Each IEEE 32-bit floating point number requires two consecutive registers (four bytes, MSB=4, LSB=1 in byte order below) starting with the register defined as the starting register for the information. The stuffing order of the bytes into the two registers differs among Modbus hosts. To provide compatibility, the Double register format is configurable. Selections are:

FPB Floating Point Big Endian Format Byte order - 4, 3, 2, 1 (Default)

FP LB Floating Point Little Endian with byte-swapped Byte order - 2, 1, 4, 3

FP BB Floating Point Big Endian with byte-swapped Byte order - 3, 4, 1, 2

FP L Floating Point Little Endian Format Byte order - 1, 2, 3, 4

**Port Enable:** Enables or disables port.

**Speed (bps):** Select Baud rate. All slaves on the same PC port must be the same.

**Modbus parity:** Odd or even. All slaves must be the same.

**Modbus stop bits:** 1 or 2. All slaves must be the same.

**Set** – Activates settings. If you changed the controller's Baud Rate via a PC RS232 Comm Port, your PC will no longer communicate with the controller. In this case, you are prompted to detect the

controller's Baud Rate. This feature will synchronize the PC's Comm Port with the controller and set the PC Baud Rate to the correct Baud Rate.

## Modbus RTU Master - Advanced Setup

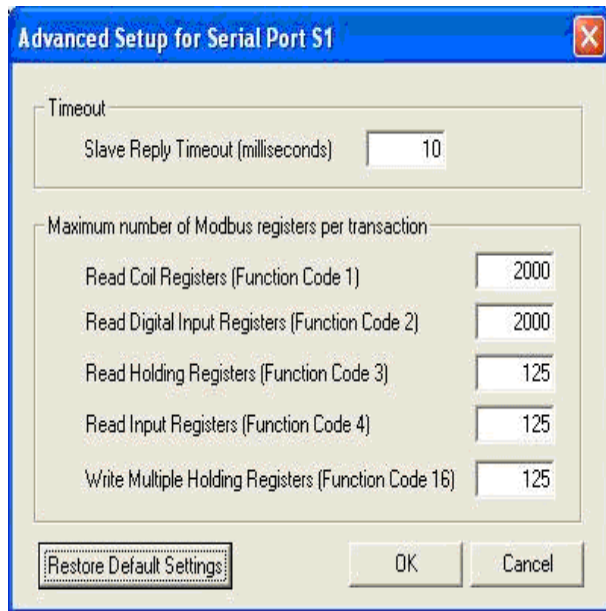

### Overview

The Modbus RTU Master Advanced protocol provides enhanced data throughput for applications where the HC900 is being used in conjunction with a “Modbus-to-fieldbus” gateway device. In these applications the gateway acts as a Modbus slave to the HC900 controller. The Modbus data is connected into the HC900 control strategy using the Modbus Read, Modbus Write, and Modbus Slave function blocks.

In order to achieve the enhanced data throughput, the HC900 communicates with the gateway using large packets of contiguous Modbus register addresses. This packetization technique allows the HC900 to exchange data with the gateway at rates up to the analog cycle rate of the controller (depending on the operating characteristics of the gateway device). The packet sizes can be adjusted to match the specifications of the gateway slave device.

### Differences from standard Modbus RTU

There are several important ways in which the Advanced protocol differs from the standard Modbus RTU Master protocol:

1. Under the Advanced protocol the Modbus register data is written to the slave devices during every Modbus Master scan cycle. This behavior is different than the standard Modbus RTU Master protocol, where the data is written only when the slave block's Enable pin is ON.
2. The Enable pins on the Modbus function blocks do not control when the register data is written to the slave device. Instead, they control the value that is written to the block. For example, if a Modbus function block has the value 10 on its Write pin and the Enable pin is ON, then a value of 10 is written to the slave device. If the Enable pin is changed to OFF, the HC900 controller will continue to write a value of 10 to the slave device once every Modbus Master scan cycle. If the value on the Write pin is changed to 100 while the Enable pin is OFF, the controller will continue to write a value of 10 to the slave device. The next time the Enable pin is changed to ON, the controller will write the value 100 to the slave device.

3. Modbus Register write operations are performed using Modbus Function Code 16 (Preset Multiple Write). The number of registers written in a single transaction is based on the Advanced Setup settings for the serial port.

4. If there are “gaps” in the Modbus register addresses referenced within the HC900 configuration, the controller will write a value of zero to the “undefined” registers. For example, if Modbus Registers 1 and 10 are assigned to Modbus function blocks but Registers 2 through 9 are not, the controller will write zeroes to Registers 2 through 9.

The Advanced protocol can be used in any Modbus Master application that can accommodate these differences.

### **Factors affecting scan time**

Using the Advanced protocol, the HC900 controller can potentially scan all of the Modbus registers on the serial link at a rate that is equal to the analog cycle time. The actual scan time for any given application is affected by the following factors.

1. Characteristics of the slave devices (e.g., the maximum baud rate, the message turn around time, support for Modbus packets, the maximum allowable packet size, etc.).
2. Configuration of the Modbus slave blocks.
3. Programmed baud rate of the serial port.

The Modbus Master scan time is adjusted automatically by the HC900 at run-time; no user intervention required. The actual scan time of the link is displayed on the Modbus Communication Diagnostics display in Monitor Mode.

### **Configurable parameters**

The parameters on this dialog can be used to match the behavior of the Advanced protocol to the characteristics of the slave devices on the link. Please consult the documentation for your slave devices to determine the best settings for your application. In general, the best overall performance of the Modbus Master Advanced link can typically be achieved by using the largest possible packet sizes.

#### **Slave Reply Timeout (milliseconds)**

This parameter defines the Modbus message turnaround time for the link. It has a range of 10ms to 255ms. This parameter should be set to handle the slave device that has the worse case turnaround time on the link. If there are slave devices with turnaround times that are longer than 255ms, then the standard Modbus RTU Master protocol must be used.

#### **Maximum Number of Modbus registers per transaction**

##### **Read Coil Registers (Function Code 1)**

This parameter determines the maximum number of coil registers that can be read from the slave devices in a single transaction.

##### **Read Digital Input Registers (Function Code 2)**

This parameter determines the maximum number of digital input registers that can be read from the slave devices in a single transaction.

##### **Read Holding Registers (Function Code 3)**

This parameter determines the maximum number of holding registers that can be read from the slave devices in a single transaction.

##### **Read Input Registers (Function Code 4)**

This parameter determines the maximum number of input registers that can be read from the slave devices in a single transaction.

#### **Write Multiple Holding Registers (Function Code 16)**

This parameter determines the number of registers that will be written to the slave devices in a single transaction. Note: if there are gaps in the Modbus register addresses referenced within the HC900 configuration, the controller will write a value of zero to the undefined address. For example, if Modbus Registers 1 and 10 are assigned to Modbus function blocks but Registers 2 and 9 are not, the controller will write zeroes to Registers 2 and 9.

#### **Restore Default Settings**

This button allows you to restore the original default settings for the Advanced Setup parameters.

Note: you must click the Set button on the Set Protocol dialog to activate any changes that are made on this dialog.

## Set Controller Mode

Set Controller Mode lets you set the controller mode. It can only be set when the controller's mode switch is in the center "Run Mode" position.

**ATTENTION:** If the controller's mode switch is in one of the "Locked" positions, the mode cannot be changed from this position. It can be changed only by changing the position of the switch.



opens the **Set Controller Mode** dialog box. Follow the steps on the dialog box

Select a new mode - RUN, PROGRAM, or OFFLINE

Write the new mode to the controller. Press "Set New Mode" button

Program to Run takes some time. An Indicator on the dialog box shows the progress.

## Set Controller Network Parameters



opens the "**Controller Identification Setup Wizard**" dialog box.

You can select a serial port or the Ethernet port over which the network parameters will be read/written.

The controller must be in PROGRAM mode to set the Network Parameters.

There are set up options on the wizard. The option you choose depends on how you are connected to a controller and what current knowledge you have of that controller.

**Important:** *before configuring your controller to work on a corporate LAN, consult with your Network Administrator regarding any corporate networking policies.*

**Follow the Wizard instruction to set:**

### **Network Name**

User assigned name - can be different from controller name (16-character ASCII name. It is not part of configuration.)

It is required to uniquely define a Peer group if multiple processes, each with its set of peer controllers, are on the same physical cable. The controller binds the "Network name: Controller name" to the IP address of each of its peers at run-time.

### **Local Name** (alias)

User assigned 16-character ASCII name [can be different from controller name]

It is not part of the configuration.

See Controller Identification for more info on names.

### **Modbus TCP Double Register format**

Each IEEE 32-bit floating point number requires two consecutive registers (four bytes, MSB=4, LSB=1 in byte order below) starting with the register defined as the starting register for the information. The stuffing order of the bytes into the two registers differs among Modbus hosts. To provide compatibility, the Double register format is configurable. Selections are:

FP B Floating Point Big Endian Format Byte order - 4, 3, 2, 1 (Default)

FP LB Floating Point Little Endian with byte-swapped Byte order - 2, 1, 4, 3

FP BB Floating Point Big Endian with byte-swapped Byte order - 3, 4, 1, 2

FP L Floating Point Little Endian Format Byte order - 1, 2, 3, 4

### **IP Address**

**Controller Internet Protocol Address** - Guaranteed unique address, assigned by the Internet Corporation of America for Assigned Names and Numbers (ICANN) IP Address includes four

"Octets" (eight bits, translating to integers from 0 to 255, separated by periods). The manufacture default IP Address is 192.168.1.255.

### **Subnet Mask**

**Subnet Mask** defines the **netid** (Network ID) and the **hostid** (Host ID) parts of an IP Address. The **netid** uniquely identifies a network, and the **hostid** uniquely identifies a computer on the network.

The Subnet Mask can be used to partition the Network into sub-networks, using parts of the **hostid** to define new **netids**, or more correctly **subnetids**.

Portioning a network in this way enables switches and routers to use the subnetids to reduce collision domains and to promote security.

### **Gateway IP Address**

Used to forward packets to other networks and subnets. The Network Administrator typically provides this address.

### **Email Server**

Outgoing Mail (SMTP) server IP Address: If the controller is configured for E-mail notification, enter the IP Address of the (SMTP) E-mail server.

## **Controller Identification**

The figure below shows how to uniquely identify multiple controllers on a network. Notice the controller names can be the same in both furnaces (Larry, Curly, Moe), but within the same network name they must be unique. To further distinguish controllers, use unique network names (Furnace #1 and Furnace #2). Network name:Controller name are bound to the IP address of each controller. Finally, use a local name (alias) to identify each controller to the end user. This local name is a convenient name such as for displays on the PC, it is not referred to for actual communication.

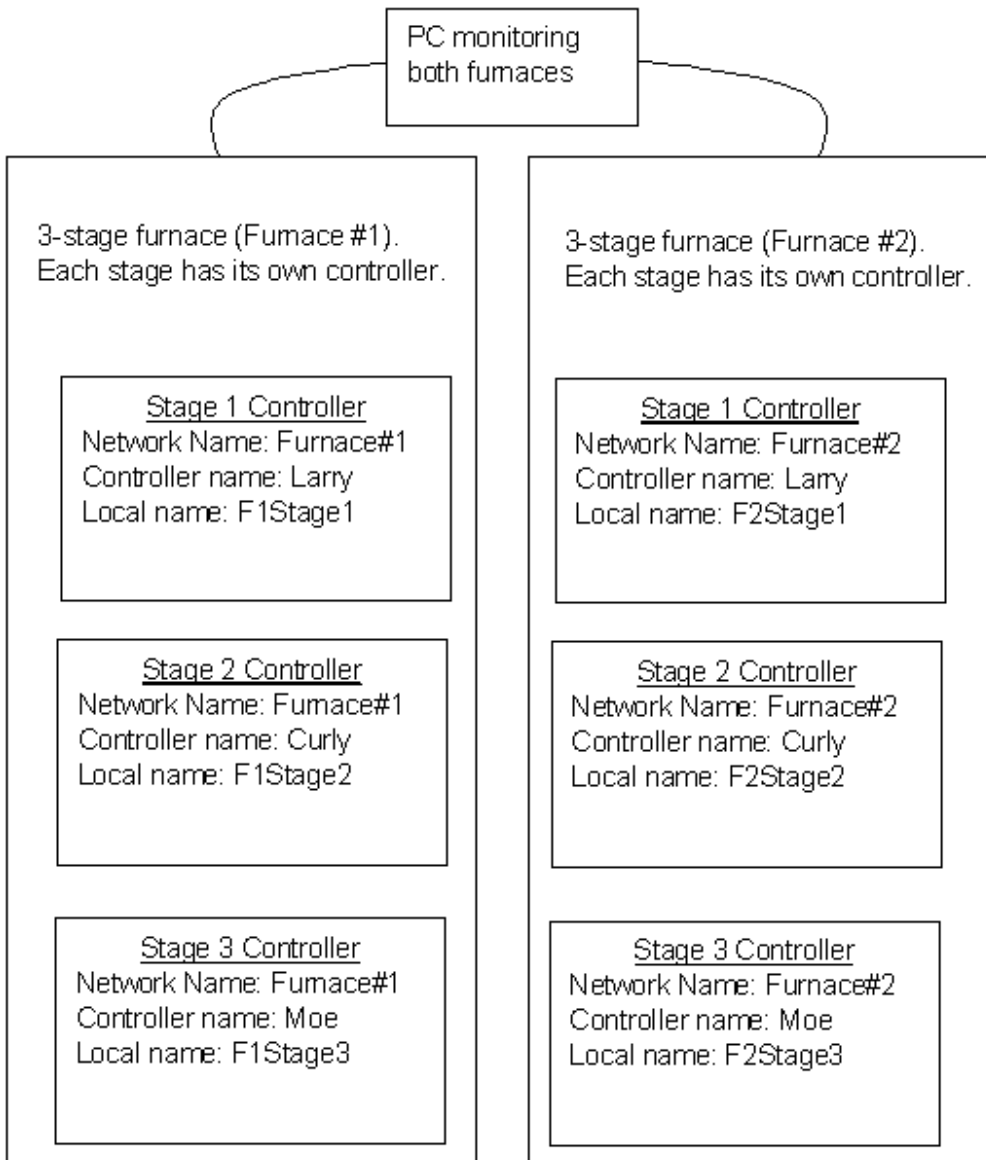

## Set Controller Time



opens the **Set Controller Time** dialog box. Screens differ according to the version of HC Utilities.

### Version 4.0 and earlier

This window lets you set your controller's date and time.

Note: Use of Daylight Saving or Network Time Server requires Version 4.1.

Group	Item	Description	Action
PC Time	Current Date Current Time Time Zone	Indicates PC's date, time and time zone.	Read Only.
Controller Time	Current Date Current Time	Shows Controller's current date and time This is updated when you click on Set Controller Time button below.	Read only.
Select method for writing Time and Date to the Controller	Set to PC Time	PC's date and time, indicated here, will be used by controller.	Click radio button to select.
	Manually Override Time	Date and time entered here will be used by controller.	Click radio button and enter desired date and time.
	Set Controller Time	Writes PC or manual Date and Time to the controller. Current Controller Time (top of window) will be updated. A status message confirms the update.	Click to set time.

### Version 4.1 and later

There are two tabs in this window.

Time and Date tab - Lets you set controller time to the PC time and assign a time zone to the controller.

Network Time Server and DST tab - Lets you assign a Network Time Server that periodically synchronizes the controller time. Lets you specify when controller time changes to Daylight Saving.

#### Version 4.1 Time and Date tab

Group	Item	Description	Action
Current PC Time	Current Date Current Time Time Zone	Indicates PC's date, time and time zone, including Standard or Daylight Saving.	Read Only.
Current Controller Time	Current Date Current Time Time Zone	Shows Controller's current date, time and time zone. Note: Daylight Saving, if applicable, is not shown unless Controller is in RUN mode.	Read only.
Set Controller Time and Date	Date Time	PC's date and time, indicated here, will be used by controller.	Read only.
	Use Controller Time Zone	Time zone entered here will be used by controller.	Click to select. Enter desired Time Zone.
	Use PC's Time Zone	Time zone displayed here will be used by controller.	Read only. Click to select.
	Set Controller Time	Click to write the above Date, Time and Time Zone to the controller. Current Controller Time (top of window) will be updated. A status message confirms the update.	Click to select.

**Version 4.1 Network Time Server and DST tab**

Use this tab to

- assign a Network Time Server that periodically synchronizes the controller time,
- specify when controller time changes to Daylight Saving.

<b>Group</b>	<b>Item</b>	<b>Description</b>	<b>Action</b>
<b>Network Time Server</b>	<b>Enabled</b> <b>Disabled</b>	<p>Disabled - controller's time will not be synchronized with a network time server.</p> <p>Enabled - controller's time will be periodically synchronized to a network time server in Greenwich Mean Time. <a href="#">Different time zone</a> or <a href="#">Daylight Saving</a> must be configured separately.</p> <p>Disable or enable will take effect when you click on Write Time Server Settings to Controller.</p>	Click to select.
<b>Time Server IP Addresses</b>	<b>Primary</b> <b>Secondary</b>	<p>Primary - primary time server's IP address.</p> <p>Secondary - secondary time server address as a backup in case the primary can't be accessed.</p>	Enter addresses. If using one server only, enter the same address as the primary.
<b>Write Time Server Settings to Controller</b>		<p>Writes time server settings (enable or disable) to controller. Status will confirm the completed write. This button does not update the controller time, it just enables the connection. To see the current controller time, go to the <a href="#">Time and Date tab</a>. Important: Network time servers use Greenwich Mean Time. Go to the <a href="#">Time and Date tab</a> and set the time zone for your controller.</p>	Click to write to the controller.
<b>Daylight Saving Mode</b>	<b>Adjust Clock for Daylight Saving Changes</b>	Lets you select one of the three Daylight Saving methods below.	Check box to enable one of the following options.
	<b>Use DSTI Pin on Time and Date Function Block</b>	Controller time will be in Daylight Saving when DSTI pin on the <a href="#">Time and Date function block</a> is ON. Time will be in Standard when pin is OFF.	Click to select.
	<b>One Year</b>	Controller time will change to Daylight Saving, then to Standard, on the dates and times specified for a single year.	Click to select. Enter dates and times. Begin Daylight Saving Time setting must be earlier than Begin Standard Time setting.

Group	Item	Description	Action
	Every Year	Controller time will change to Daylight Saving, then to Standard, on the weekdays and times specified for every year.	Click to select. Enter dates and times. Last will be either 4th or 5th week, whichever is last.

## Data Storage Utility

**Note:** The section does not apply to the 900 Control Station.



opens the **Data Storage Disk Initialization Utility** dialog box.

It is used to initialize ZIP disks offline. (It takes a long time to initialize a disk on the Operator Interface)

### Pre-initializing ZIP Diskette

Step	Action
1	Insert the 100MB Zip disk into your PC drive.
2	Select the Data Storage Utility Icon on the Utilities toolbar.
3	The dialog box appears.
4	Select a Drive Letter from the drop-down menu to specify the drive on your PC.
5	Select the number of Trend Groups that the Operator Interface will need from the drop down menu .
6	Click on Pre-initialize to prepare the disk for storage.
7	Exit DSU.
8	Remove disk, insert it into the operator Interface, and initialize it. See Initializing Disk under this section entitled "Data Storage Operation".

## Back Up Controller Information

Saves a controller's active configuration as a backup file with .cbk extension. Similar to saving an uploaded configuration except that in addition to the configuration the port settings are saved. Versions 4.1 and up saves time settings (time zone, DST, NTS IP addresses). You are prompted to specify the comm. link settings for the controller to be backed up. Backup files are read-only; to edit you must save as .cde.

Back up Controller

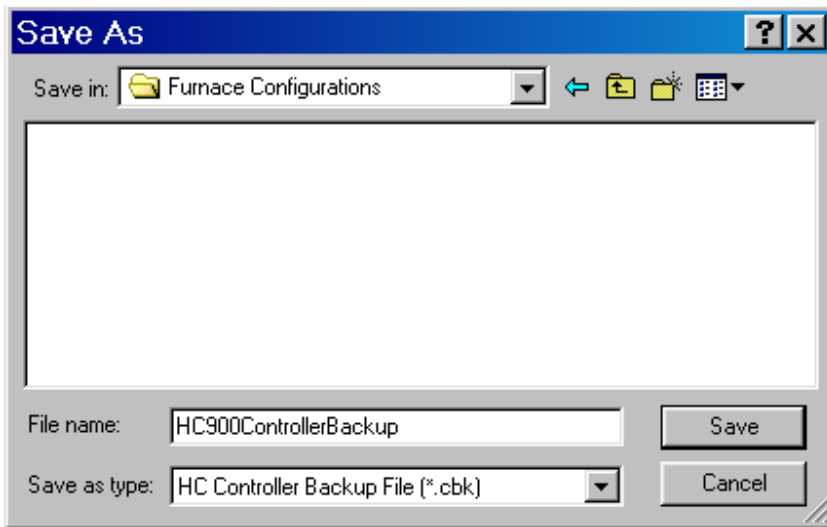

## Restore Controller Information

This button is visible for currently open backup files (.cbk).

Choices:

Back Up Controller

Restore Controller – Same as doing a download to controller except port settings are also downloaded.

View Port Settings – Shows all port settings in the backup file.

Serial S1/Serial S2 ports:

**Back Up Controller Information**

Serial-S1 | Serial-S2 | General Properties | Network-E1 | Network-E2

Honeywell ELN  
 Modbus RTU Master  
 Modbus RTU Slave

Slave Type: [ ]  
Slave Address: 255  
Modbus Slave Double Register Format: FP B - Big Endian (4,3,2,1)  
Port Enable: Enabled

Speed (bps): 38400  
Modbus Parity: none  
Modbus Stop Bits: 1

Close

General properties:

The screenshot shows a dialog box titled "Back Up Controller Information" with a close button (X) in the top right corner. The dialog has five tabs: "Serial-S1", "Serial-S2", "General Properties" (which is selected), "Network-E1", and "Network-E2". Below the tabs, the text reads: "The Controller has the following identification settings." There are five input fields: "Network Name" with the value "NETWORK1028", "Controller Name" with "FURNACE1", "Local Name (alias)" with "ERIC70R1028", "Modbus TCP double register format:" with a dropdown menu showing "FP L - Little Endian (1,2,3,4)", and "Email Server - Outgoing Mail (SMTP) server IP Address:" with a text field containing "0 . 0 . 0 . 0". A "Close" button is located at the bottom center of the dialog.

Network E1, Network E2 ports:

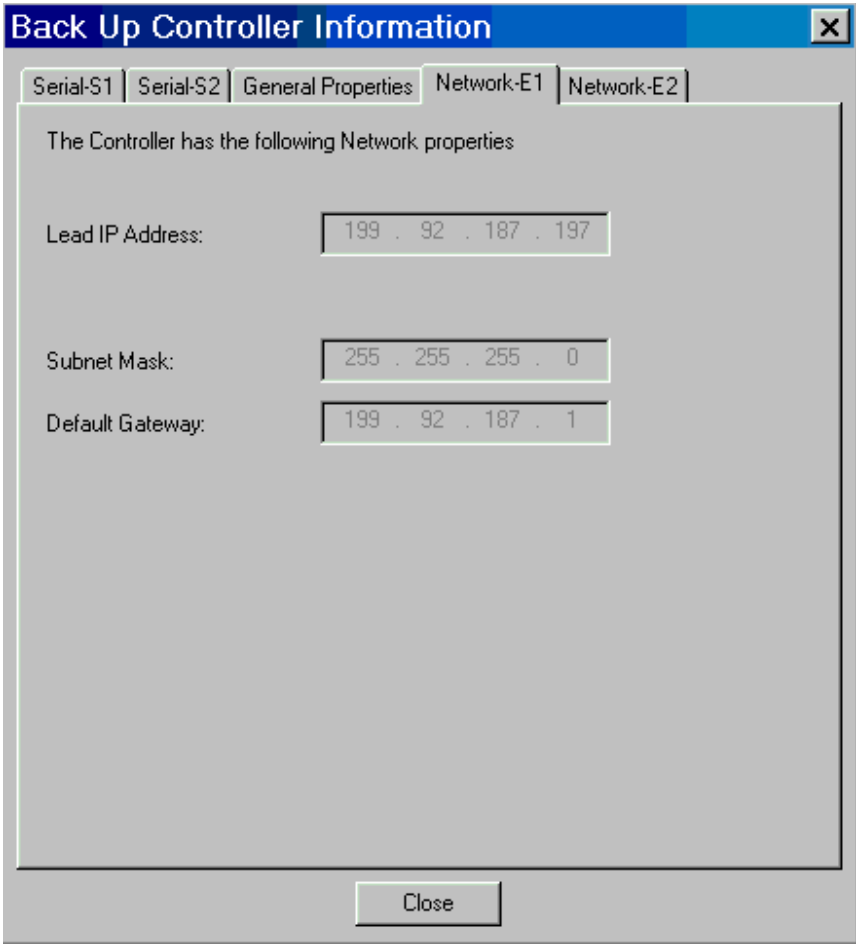

### Manually Write Database to Flash

Causes the configuration and user settings of a controller to be written (saved) to the controller's FLASH memory. User settings include, for example, PID tuning parameters, PP Output calibrations and changes to recipes (setpoint profiles, sequences, schedules). These settings are normally saved in battery-backed RAM, but if there is a power failure and the battery dies, these settings would be lost. By allowing an on-demand write of the database to FLASH, these settings will be retained and available immediately upon power-up.

If using redundant CPUs (C70R) the database is saved to the FLASH of both Lead and Reserve controllers. On-demand write to flash memory is not available for C30 and C50 CPU types.

## Diagnostics



has menu selections on a drop-down menu. It lets you select from a list of diagnostic windows for various controller connections.

The controller must be in "Monitor" mode. Select Monitor Mode from the Monitor menu or click on the Monitor mode icon on the Main toolbar.

Controller Diagnostics - displays controller status and diagnostic parameters.

Rack Diagnostics - displays the "Rack Diagnostic Summary" dialog box. Information is for Rack, I/O expansion (when applicable), and Module diagnostics.

Controller Ports Diagnostics - select a port from the drop-down list.

- Serial Port S1
- Serial Port S2
- Network Port
- Expansion Rack Port (except C30 CPU)
- Host Connections
- Peer-to-Peer connections

Modbus Port Diagnostics - displays status of the Modbus ports.

- Modbus Master (Serial) Port Diagnostics
- Modbus/TCP Initiator Port Diagnostics

Forced Blocks.- displays a list of Function Blocks, by block ID, that have a forced output pin.

Redundancy – select from the drop-down list:

- Redundancy System
- Redundancy Link
- Lead CPU
- Reserve CPU
- Scanner 2 Link

## Calibrate Modules

### Overview

The controller I/O modules are factory calibrated to 0.1% accuracy. But, if greater accuracy is required, you can calibrate the **AI and AO modules** using the Hybrid Control Utilities on-line connected to the controller.

You can also calibrate the **Position Proportional Output block**. The calibration of the PPO block is similar to that of the AI and AO except that the calibration values are stored as part of the block's configuration, not on the AI card itself.

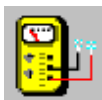

opens the **Calibrate Modules** dialog box.

There are four tabs on the Dialog Box:

**AI Channel** - see "Calibrate AI Channel".

**CJ Temp** - see "Calibrate CJ Temp".

**AO Channel** - see "Calibrate AO Channel".

**PPO Block** – see "Calibrate Position Proportional Output "

## Calibrate AI Channel

The Calibrate AI Channel tab allows you to calibrate the selected AI to ensure that the 0 and 100% values selected during configuration is actually correct.

**ATTENTION:** *You should not access the Utilities Calibrate Controller Analog I/O display while the OI calibration display is being displayed, or vice versa. Calibration can't be done as long as both displays are shown; user must exit either display to do a calibration.*

### To calibrate an AI Channel:

Enter a Rack #, Module #, and Channel #.

Click on Select Input. The program will then poll the controller to see if the selected AI exists.

The Cal 0% button is now available. Connect a reference supply to the input pins of the AI.

The reference supply must have the following characteristics:

T/C, mV, Volts Inputs: 1 microvolt resolution

Ohms, RTD Inputs: 0.1 Ohm resolution

4-20mA inputs: 4 microamp resolution

Set the reference supply to the reference value shown. (The reference value is displayed below the Instrument Status section.) Click on "Cal 0%" to calibrate the low end of the AI.

The Instrument Status section of the dialog will display the results of the calibration.

If the 0% calibration was successful, the 100% button is now available. Set the reference supply to the reference value shown. Click on "Cal 100%" to calibrate the high end of the AI.

If the Cal 100% calibration was successful, the Save Cal button is then available. Click on "Save Cal" to save the current set of calibrations for the selected AI.

If either calibration fails,

the *Instrument Status* section will display an AI Calibration Failed message - Check connections

The *Reference* section will display a wrong Rack, Module, and channel - reenter Addresses.

Click on Close.

Note: Click on "Restore Factory Calibration" button to do same.

**NOTE:** *Refer to the Calibration section in the HC900 Installation and User Guide for additional Hardware details.*

## Calibrate CJ Temp

The Calibrate CJ Temperature tab allows you to ensure the Cold Junction calibration is correct.

### To calibrate a CJ Temperature:

Enter a Rack #, Module #, and Channel #.

At CJ Temperature, enter the actual ambient temperature (measured at the AI pins).

Click on Select CJ Input. The program will then poll the controller to see if the selected AI exists. If the AI is found the Cal CJ button will then be available.

Click on the Cal CJ button to initiate the calibration. The status of the calibration is displayed in the Instrument Status section of the dialog. If the calibration is successful, the Save Cal button will be available.

Click on the Save Cal button to save the current CJ calibration.

If the calibration fails, a message will be displayed in the Instrument status section.

Click on Close to close dialog.

Note: Click on "Restore Factory Calibration" button to do same.

**NOTE:** Refer to the Calibration section in the HC900 Installation and User Guide for additional Hardware details.

## Calibrate AO Channel

The Calibrate AO Channel option allows you to calibrate the selected AO to ensure that the 0 and 100% values selected during configuration are actually correct.

**ATTENTION:** You should not access the Utilities Calibrate Controller Analog I/O display while the OI calibration display is being displayed, or vice versa. Calibration can't be done as long as both displays are shown; user must exit either display to do a calibration.

### To calibrate an AO Channel:

1. Enter a Rack #, Module #, and Channel #.
2. Click on Select Output. The program will then poll the controller to see if the selected AO exists.
3. The Cal 0% button is now available. Measure the actual output of the AO at the terminal block with a meter and enter the measurement into 0% Measured. Click on Cal 0% button to calibrate the 0% measurement. The reference value is displayed below the Instrument Status section.
4. The Instrument Status section of the dialog will display the results of the test.
5. If the 0% calibration was successful, the 100% button is now available. Measure the actual output of the AO at the terminal block with a meter and enter the measurement into 100% Measured. Click on Cal 100% button to calibrate the 100% measurement.
6. If the Cal 100% was successful, the Save Cal button is then available. Click on Save Cal in order to save the current set of calibrations for the selected AO.
7. If either of the tests fail, the Instrument Status section will display an AO Calibration Failed message.
8. Click on Close.

Note: Click on "Restore Factory Calibration" button to do same.

**NOTE:** Refer to the Calibration section in the HC900 Installation and User Guide for additional Hardware details.

## Restore Factory Calibration

To restore the Factory Calibration:

Click on the Restore Factory Calibration button on the dialog box. The Restore Factory Calibration dialog is displayed.

Enter the Rack, Module, and Channel number for the desired calibration.

Click on Restore to initiate the task. The status of the restore will be displayed in the Instrument Status section of the dialog.

Click on Close to close the dialog when the restore is complete.

## PPO Block Calibration Overview

### Introduction

The Calibrate PPO Block tab allows you to calibrate the selected Position Proportional Output Block to ensure that the 0% and 100% Motor Positions are actually correct and to measure the true motor speed.

The calibration of the PPO Block is similar to that of the AI and AO. However, the calibration values are stored as part of the PPO block's configuration data; not on the AI card itself.

To retain these calibrated values, upload and save the configuration to disk.

The procedure is to move the motor first to its 0% position, wait until the position feedback signal has stabilized, and capture the 0% feedback value.

A similar procedure is done next for the motor's 100% position,

The third step is to measure the true motor speed by moving the motor a fixed period of time, measuring the position feedback delta, and computing a motor speed from this data.

The final step is to save the values in the block's configuration data. All previous calibration values will be overwritten.

### Calibration Procedures

There are three methods for calibrating the PPO block. Click on one of the modes shown below for instructions.

**AUTO** – Controller positions the motor and captures the positions.

**SEMI-AUTO** – Controller positions the motor and the user captures the positions.

**HAND** – User positions the motor by hand and captures the positions.

### Auto Calibration Procedure

**Controller automatically positions the motor and captures the positions.**

*NOTE: Put the controller in "Offline" or "Program" mode in order to perform calibration.*

Select the **Utilities tab** at the bottom of the Main Window



Under the "Controller Utility Functions", select the **"Calibrate Controller"** icon.

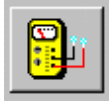

The "Calibrate" dialog box will open.

Select the **"PPO Block" tab** at the top of the dialog box.

In the "Calibration Block" field, drop-down the list of PPO blocks and **select one**.

Under "Calibration Mode", select the **"AUTO" radio button**.

Under "Calibration Procedure", press **"Start"**.

#### **Result:**

The "Start" button is disabled and the Status indication at the top of the dialog box will change to indicate that the motor is moving to its 0% position.

The "Feedback Value" area on the dialog will indicate movement and direction of the motor.

The Progress Bar will indicate progress (Time Remaining) for this step.

The status will change to indicate that the motor is at its 0% position.

The status will change to indicate that the 0% position has been captured.

The status will change to indicate that the motor is moving to its 100% position and the feedback area will indicate movement and direction of the motor.

The progress bar will indicate progress (Time Remaining) for this step.

The status will change to indicate that the motor is at its 100% position.

The status will change to indicate that the 100% position has been captured.

The status will change to indicate that the motor is currently undergoing speed calibration.

The feedback area will indicate movement and direction of the motor.

The progress bar will indicate progress (Time Remaining) for this step.

The status will change to indicate that the PPO Calibration has been saved.

A message box appears indicating that the calibration is complete.

Three choices will also appear. **Select one.**

**Press F2 to Position Motor at 0%**

**Press F3 to Position Motor at 100%**

**Press F4 to Leave Motor at Current Position**

### Semi-Auto Calibration Procedure

**Controller automatically positions the motor and the user captures the positions**

*NOTE: Put the controller in "Offline" or "Program" mode in order to perform calibration.*

Select the **Utilities tab** at the bottom of the Main Window.



Under the "Controller Utility Functions", select the **"Calibrate Controller" icon**

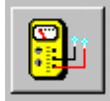

The "Calibrate" dialog box will open.

Select the **"PPO Block" tab** at the top of the dialog box.

In the "Calibration Block" field, drop-down the list of PPO blocks and **select one**.

Under "Calibration Mode", select the **"SEMI-AUTO"** radio button.

Under "Calibration Procedure", press **"Start"**.

The "Start" button is disabled and the Status indication at the top of the dialog box will change to indicate that the motor is moving to its 0% position.

The "Feedback Value" area on the dialog will indicate movement and direction of the motor.

The Progress Bar will indicate progress (Time Remaining) for this step.

The status will change to indicate that the motor is at its 0% position.

Click the **Cal 0% button**, then the status will change to indicate that the 0% position has been captured.

The status will change to indicate that the motor is moving to its 100% position.

The feedback area will indicate movement and direction of the motor.

The progress bar will indicate progress (Time Remaining) for this step.

The status will change to indicate that the motor is at its 100% position.

Click the **Cal 100% button**, then the status will change to indicate that the 100% position has been captured.

Click the **Cal Speed button**.

A dialog box will appear warning that the speed calibration will move the motor.

**Press "OK"** to start or **"Cancel"** to abort.

The status will change to indicate that the motor is currently undergoing speed calibration.

The feedback area will indicate movement and direction of the motor.

The progress bar will indicate progress (Time Remaining) for this step.

Click the **Save Cal button**.

A dialog box will appear that confirms the Motor Calibration Values.

**Press "OK"** to save the values or **"Cancel"** to abort.

The status will change to READY and indicate that the PPO Calibration has been saved.

A message box appears indicating that the calibration is complete.

Three choices will also appear. **Select one.**

**Press F2 to Position Motor at 0%**

**Press F3 to Position Motor at 100%**

**Press F4 to Leave Motor at Current Position**

### Hand Calibration Procedure

**User positions the motor by hand and captures the positions.**

*NOTE: Put the controller in "Offline" or "Program" mode in order to perform calibration.*

Select the **Utilities tab** at the bottom of the Main Window.

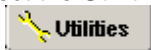

Under the "Controller Utility Functions", select the **"Calibrate Controller" icon**.

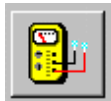

The "Calibrate" dialog box will open.

Select the **"PPO Block" tab** at the top of the dialog box.

In the "Calibration Block" field, drop-down the list of PPO blocks and **select one**.

Under "Calibration Mode", select the **"HAND"** radio button.

Under "Calibration Procedure", press **"Start"**.

The "Start" button is disabled and the Cal 0% button is enabled.

Move the motor **by hand to its 0% position**.

The feedback area will indicate movement and direction of the motor when it is moving.

When ready, click the **Cal 0% button** and the 0% position of the motor is captured as indicated in the status.

Move the motor **by hand to its 100% position**.

The feedback area will indicate movement and direction of the motor when it is moving.

When ready, click the **Cal 100% button** and the 100% position of the motor is captured as indicated in the status.

Click **the Cal Speed button**

A dialog box will appear warning that the speed calibration will move the motor.

**Press "OK"** to start or **"Cancel"** to abort.

The status will change to indicate that the motor is currently undergoing speed calibration.

The feedback area will indicate movement and direction of the motor.

The progress bar will indicate progress (Time Remaining)

Click **the Save Cal button**.

A dialog box will appear that confirms the Motor Calibration Values.

**Press "OK"** to save the values or **"Cancel"** to abort.

The status will change to READY and indicate that the PPO Calibration has been saved.

A message box appears indicating that the calibration is complete.

## Set Point Programming

### Terms and Definitions

Term	Definition
<b>Auxiliary Analog Value</b>	In addition to the main ramp and soak output value, a second analog value is available for each step of the profile. This output is a fixed soak value, which may be used to provide a setpoint value for a secondary control loop in the process. An example would be a ramp and soak temperature program combined with pressure setpoints for each step of the profile.
<b>Cycles</b>	A portion of a profile or the entire program may be repeated up to 100 times or indefinitely as specified in the program <b>Cycles</b> count value.
<b>Engineering Units</b>	You must assign a descriptor consisting of up to 4 keyboard characters for the engineering units that the setpoint value represents. For example, <b>GPM</b> for gallons per minute, <b>NPS</b> for number per second, <b>RPM</b> for revolutions per minute, and <b>DEGF</b> for degrees Fahrenheit.
<b>Guaranteed Hold Soak Limits</b>	Limits High and Low (above and below the Setpoint value) can be configured in selected engineering units. If the PV is outside of configured limits just prior to entering the Soak segment, the soak timer will not be permitted to start. It will start when the PV is within the High and Low limits. Once the soak timer has started and then the PV goes out side of configured limits, the soak timer will halt. It will remain halted until the PV is again within the configured limits. A Guaranteed Hold High or Low limit setting of 0.00 is equal to no limit at all.
<b>Number of Segments</b>	Segments are timed ramp and soak subdivisions of a setpoint program. Consecutive ramps and soaks are allowed. The last segment must be a soak.
<b>Power Loss</b>	A <b>recovery ramp rate value</b> is provided in the event of a power loss while a program is running. The ramp rate value is used to return the process to the last operating setpoint prior to power loss. A power OFF digital input and separate timing block will abort the running program if power loss has been OFF for more than a specified time period.
<b>Program</b>	The term "Program" is used to identify the process for selecting and entering the individual ramp and soak segment data for a Setpoint Program function block ( <b>SPP</b> ) needed to generate a required setpoint versus time <b>profile</b> (also called a program).
<b>Program Name</b>	During configuration you must assign a name (descriptive reference) consisting of from 1 to 8 letters or numbers without spaces. Thus, a name can be a combination of letters and numbers. Note that lowercase letters are automatically converted to uppercase.
<b>Program Number</b>	This number is assigned when the software or the Operator Interface creates the profile. The program number is assigned in the "Setpoint Profile Pool" and is shown on the "Edit Setpoint Profile" dialog box.
<b>Ramp Segments</b>	A ramp segment is a starting setpoint and the time or rate to reach the setpoint of the following segment.  Typically, segment #1 will be a ramp. Ramp time is determined in either:  <b>TIME*</b> —Hours or Minutes Range = 0.00 hr. to 999.99 hr. / 0.00 min. to 999.99 min.  OR  <b>RATE*</b> —EU/MIN or EU/HR Range = 0 to 999.99

Set Point Programming  
What is a Setpoint Program?

Term	Definition
	<p>*This selection of time or rate is made when you configure properties.</p> <p>Make this selection before entering any Ramp during Profile Edit.</p> <p>NOTE: When Ramp unit is configured for TIME, entering "0" will imply an immediate step change in setpoint to the next soak</p>
<b>Running a Profile</b>	<p>Setpoint profiles may be <b>started, held, advanced, jogged</b> to a predefined segment or reset from the operator interface or by digital inputs to the block. Programs may be started from a pre-selected segment number.</p>
<b>Segment</b>	<p>A segment is a ramp or soak function which together make up a Setpoint Profile.</p>
<b>Segment Events</b>	<p>You can configure 1 to 16 segment events to turn ON or OFF at the beginning of each segment. Segment events are digital switches that provide ON/OFF outputs through an SPEV control block. <b>When a segment event is turned ON, it remains ON until the end of the segment at which time it is turned OFF unless it is configured to turn ON in the next segment.</b> Note that segment events are not interrupted by soak time delays when the process variable is outside the guaranteed soak band. Events turn ON as soon as the previous segment is completed even if the process variable has not reached the soak setpoint. When the program completes, the events are held at current value until the programmer is returned to the ready state.</p>
<b>Setpoint Guarantee</b>	<p>There is a setpoint guarantee function provided that holds the program if a PV exceeds a predefined deviation from setpoint. Selections allow setpoint guarantee to be active for all segments, soak segments only, or for specified segments. Up to 3 Process Variables may be configured as inputs to the block for setpoint guarantee.</p>
<b>Setpoint Value</b>	<p>A setpoint value set for <b>Ramp</b>(starting Setpoint value) and <b>Soak</b>(soak setpoint value)segments</p>
<b>Soak Segments</b>	<p>A soak segment is a combination of soak setpoint (value) and soak duration (time).</p> <p>The last segment <b>must</b> be a Soak.</p> <p>The soak setpoint range value must be within the setpoint high and low range limits in engineering units.</p> <p>SOAK TIME is the duration of the soak and is determined in:</p> <p><b>TIME*</b>—Hours or Minutes Range = 0.00 hr. to 999.99 hr. / 0.00 min. to 999.99 min.</p> <p>*This selection is made when you configure properties.</p>
<b>Synchronizing Programs</b>	<p>Two setpoint programs operating on the same time base can be synchronized using the Synchronize (<b>SYNC</b>) function block. This block automatically starts the second program when the first program is started and maintains synchronization when either program is place in hold.</p>

## What is a Setpoint Program?

A Setpoint Program is really a **setpoint versus time profile** that establishes the setpoint values and how they are to vary with time.

Each setpoint profile consists of segments. Each segment of the profile may be a ramp or a soak except the last step that must be a soak.

In addition to the main ramp and soak output value, a second analog value (Aux. Output) is available for each step of the program. This output is a fixed soak value that may be used to provide a setpoint value for a secondary control loop in the process. An example would be a ramp and soak temperature program combined with pressure setpoints for each step of the program.

Each segment can turn on segment events to provide ON/OFF signals through a Setpoint Program Events (SPEV) control block that is used in conjunction with an SPP block.

Each Profile carries its own unique number and a name for identification. (The names are descriptive references [aliases] and uniqueness is not enforced.) Unique names are recommended to avoid operator confusion).

Using the software, you can set the setpoint values, soak times, guaranteed soak band, ramp rates, and event action for individual setpoint profiles in configuration and access the information through the Setpoint profile display in the operator interface. This means that an operator can adjust individual ramp and soak segment settings during operation, but the general profile configuration, including number and name, is under configuration control.

However, any changes made through the SPP Operate display to a program that is running in an SPP block will **not** be written as changes in the program configuration.

### ***Associated Blocks***

#### **Setpoint Programmer Blocks**

## Setpoint Program Configuration Overview

### Introduction

Setpoint Program (Profile) configuration provides a quick and easy way to create, edit, and save up to 99 different ramp/soak (setpoint) profiles for the Setpoint Programmer (SPP) control blocks in the configuration. An operator can interact with the configured profiles through the Setpoint Program Operate display at the operator interface or operation can be directed through integral actions connected by Softwiring functions.

### Configuration Functions

Basic functions that you will use to configure a Setpoint Profile.

#### ***Create/Edit Setpoint Profile***

Under File-New or File-Open you can access the Profile Editor to create or edit a setpoint profile.

#### ***Setpoint Profile Pool***

The SP Profile Pool lets you view and save the configuration's setpoint profile to disk.

#### ***Setpoint Profile Properties***

Setpoint Profile Properties is information for the profile that is entered on five specific tabs. It includes Text, General, Loop/Jog, and Start/Restart.

#### ***Setpoint Profile Setup (EDIT)***

Setpoint Profile Setup lets you view each segment of the profile, the ramps and soaks and associated information (Values, Time, Auxiliary output, Guaranteed Hold, and Events).

## Setpoint Schedulers

### Setpoint Scheduler Overview

Setpoint Scheduler blocks may be configured for multi-setpoint control. Comprising the suite is a Master block (SPS), Auxiliary Setpoint block (SPSA), Event Decoder block (SPEV), State Switch Block (STSW), and State Flags block (STFL).

The Master block supports ramp or soak outputs operating on a common time base. It accepts one PV for each setpoint. Setpoint guarantee is provided for the master (SPS) block setpoints with a single symmetrical value for each setpoint output.

You can assign a Failsafe value for each setpoint.

The Auxiliary block supports soak only outputs.

The Event block supports event outputs.

A single schedule may include segments and auxiliary block data. The schedules are stored in the controller's memory.

Setpoint Schedules offer the same operating modes and digital controls as setpoint programs.

On-line editing of a running schedule is supported through dedicated operator interface displays

#### Setpoint Guarantee

Setpoint guarantee is provided for the master block setpoints with a single symmetrical value for each setpoint output. Actions for the guarantee soak may be set on a per segment basis for OFF, high setpoint deviation, low setpoint deviation or both high and low setpoint deviations.

#### Segments

Each segment of the Setpoint Scheduler allows entry of a next segment recycle location. This function allows unlimited recycle nesting and continuous recycle operation. A jog function allows a single jump to a designated segment number through a digital input to the State Switch block.

#### Labels

##### ***Main Output Labels***

Eight character labels and four character engineering units are provided for each Setpoint plus a decimal point selection.

##### ***Auxiliary Output Labels***

Eight character labels and four character engineering units are provided for each Setpoint plus a decimal point selection

##### ***Event Labels***

Eight character labels are also provided for the Digital Event block.

**Assigning these labels first will aid you in the setpoint schedule configuration process. These labels will appear in the configuration dialog boxes.**

#### ***Associated Blocks***

##### **Setpoint Scheduler Blocks**

##### **Setpoint Programmer Blocks**

### Setpoint Schedule Overview

#### Introduction

Setpoint Schedule configuration provides a quick and easy way to create, edit, and save different Setpoint Schedules for the Setpoint Scheduler (SPS) control blocks in the configuration. An operator can interact with the configured schedules through the Setpoint Program Operate display at the

operator interface or operation can be directed through integral actions connected by Softwiring functions.

### **Setpoint Scheduler Display Configuration**

#### **ATTENTION**

Before you proceed with the Setpoint Schedule assign the appropriate labels for the Setpoint Scheduler displays.

Assigning these labels first will aid you in the schedule configuration process.

See [Setpoint Scheduler Function Block](#) configuration.

These labels will appear in the configuration dialog boxes.

### **Configuration Functions**

Basic functions that you will use to configure a Setpoint Schedule.

#### Create/edit Setpoint Schedule

Under File-New or File-Open you can access the Schedule Editor to create or edit a setpoint schedule.

#### Setpoint Schedule Pool

The SP Schedule Pool lets you view a schedule on a list of configured schedules. Through this dialog box you will view the properties for each schedule.

#### Setpoint Schedule Properties

Setpoint Schedule Properties is information for the schedule that a Label, a Jog Segment, Time Units, and Guaranteed Hold Limits for each of the eight setpoints.

#### Setup/Edit Setpoint Schedule

Setpoint Schedule Setup or Edit consists of configuring each segment of the schedule and assigning starting values for all eight Setpoints of the segment and the Guaranteed Hold Type for each.

You can also set up to 16 events for each segment. Time Units, Recycle Segment, and Recycle Counts selections are included on this dialog box.

## Sequencers

### What is Sequence Control?

The need to control a sequence of operation is a very common control requirement in industrial equipment today. Sequence control can be a very rigid series of inter-related events used to start-up or shut-down a unit process, or it can be a series of timed and process measurement dependent events that are executed to produce a final product.

Sequences can be very simple with only timed or cascaded events that occur regardless of process feedback, or they can be very complex with multiple nested default sequences programmed to occur only if process feedback indicates a need to take alternate actions.

When sequence control is used to produce final product, sequence variations are often required to allow the same equipment to be used to produce multiple types of product. In these applications the sequence is often partitioned into logical units to allow operators and supervisors to monitor the progress of the process using familiar terminology. Heat-up, cool-down, filling, venting, mixing and other similar terms are often used to describe the particular phase the control equipment is executing.

Variations in the product being processed can require changes to the sequence where particular phases are bypassed, duplicated or executed in an alternate manner.

When all of these requirements are combined in a single control specification, developing a suitable control strategy can be a demanding and sophisticated endeavor.

### Sequence Configuration Overview

The sequencer function block controls the output statuses of up to 16 digital outputs and one auxiliary analog output. Each combination of outputs represents a state of the sequence such as Heat, Mix, or Cool, for example. The function block supports up to 50 states e.g. PURGE, FILL, HEAT, etc.

The sequence contains up to 64 steps. Each step enables a state, allowing for a state to be designated for several steps.

A pool of sequences, up to 64 steps each, may be stored in controller memory for quick recall and assignment to any of the 4 sequencers.

Each state supports two of digital events as inputs that can designate the end of the associated step.

Time in seconds or minutes, a manual advance, or a digital event can be used to terminate a sequencer step and cause the sequence to advance.

The operational sequence for the steps is retained in a separate sequence file in the memory pool of the controller that may be selected on-demand through a user interface or via a recipe (variables).

#### Configuration Functions

Basic functions that you will use to configure a Sequence.

##### ***Sequence Editor***

Create/Edit a Sequence under the File-New or File-Open menus. Accesses the Sequence Editor.

##### ***Sequence Pool***

When you select "Sequences" from the Recipe menu, the "Sequence Pool" dialog box will be displayed. Through this display, you will add a new sequence or delete an existing one and also enter the properties function and the "Edit Sequence" function to set up each sequence.

***Sequence Properties***

Sequence Properties is information for the sequencer: Label, Description, a Jog Step, and Time Units.

***Sequence Setup (EDIT)***

Sequence Setup or Edit consists of configuring each step of the Sequence with a State Number and Name, Time In Step, Time Next Step, Event 1 Next Step, Event 2 Next Step, Advance next step, and an Auxiliary value.

## Recipes

### Recipe Overview

#### Multiple meanings of "recipe"

Loop control users apply the word "recipe" differently in different contexts. There is no industry standard for the word's meaning. In a broader sense, a recipe is any collection of data specific to a process setup that can be downloaded into and then run as part of controller's function block configuration. The following are recipe types:

Recipe (Variables)

Set Point Profile

Set Point Schedule

Sequence

Notice the first recipe type is also called a recipe. The two uses of the word "recipe" can get confusing. In this narrower sense, a recipe is a collection of data—specifically, variables. To distinguish it from the broader meaning HC Utilities calls it "**recipe (variables)**".

To one user a recipe is a collection of variables; to another user a recipe is a set point profile; to another user a recipe is a set point schedule; to another it's a sequence. These different uses of the word "recipe" are all ok as long as you understand they are all recipes in the broader sense.

#### A recipe needs a configuration for context

A recipe by itself is useless; it must be associated with a specific controller configuration to give it context. Therefore when creating or opening a recipe you must specify by name which configuration the recipe applies to. Set Point Profiles are excluded from this requirement.

Recipe type	How linked to configuration
Recipe	Variable tag names
Setpoint Profile	Not linked to configuration
Setpoint Schedule	Event labels
Sequence	State Name, Event Signal #1, Event Signal # 2

#### Compatibility

It is up to you to understand how your recipes will work with your configurations. For example, when you download a recipe (variables).(rcp) to a controller, the recipe's variables, sequential order and their values might make sense in one controller configuration but not another.

#### Recipe locations

Once created, a recipe can reside in several places. Be aware that having multiple copies of a recipe can cause mixups. For example, suppose you've created a recipe (any type) called COOKIES. It can reside in the following places.

COOKIES saved as a separate recipe file to disk or floppy. Recipe files can be added to a recipe pool. (See Recipe file types.)

COOKIES in the recipe pool of a configuration saved to disk as a .CDE file.

COOKIES in the recipe pool of a currently open configuration in the software. (See Recipes menu)

COOKIES in the recipe pool of your controller's running configuration. Here it is available to be loaded into the controller's function block configuration.

COOKIES actively loaded and running in your controller's function blocks.

This example applies to all recipe types (recipe (variables), schedules, sequences, profiles).

### Recipe file types

Recipes saved as files have the following extensions.

Recipe (variables): .RCP

Set Point Profile: .PRF

Set Point Schedule: .SCH

Sequence: .SEQ

When part of a configuration's recipe pool, a recipe is not saved as a separate file but is saved in a "slot" in the pool as part of the configuration (.CDE). Any recipe can be accessed in the configuration's recipe pools and saved as its own recipe file if desired.

## Recipes Menu

Accesses all recipe pools. To learn about the different recipe types read Recipe Overview.

Menu Selection	Function
<b>Allocate Recipe Memory</b>	Allocates the controller's memory for the four recipe types. This is the number of recipes that can be stored in the controller's four recipe pools. Recipes in these pools can be loaded and run by Recipe Selection Blocks, Programmers, Schedulers, and Sequencers. As recipe memory usage increases, less memory is available for other parts of your configuration (such as function blocks).
<b><u>R</u>ecipes (Variables)...</b>	A recipe (variables) is a list of Variables with settings that define the ingredients needed to make a product or run a particular batch. This selection opens the Recipe Pool dialog box and allows viewing, adding, editing, and printing of Recipe details. You can save the selected recipe item to a file; open a recipe file and insert it into the pool; and download the selected recipe item to a controller's recipe pool.
<b>Setpoint <u>P</u>rofiles...</b>	Setpoint Program (Profile) configuration provides a quick and easy way to create, edit, and save different ramp/soak (setpoint) profiles for the Setpoint Programmer (SPP) control blocks in the configuration. This selection opens the Setpoint Profile Pool dialog box and allows viewing, adding, editing, and printing of Setpoint Profile details. You can save the selected SPP item to a file; open a SPP file and insert it into the pool; and download the selected SPP item to a controller's Setpoint Profiles pool.
<b>Setpoint <u>S</u>chedules...</b>	Setpoint Schedule configuration provides a quick and easy way to create, edit, and save different Setpoint Schedules for the Setpoint Scheduler (SPS) control blocks in the configuration. This selection opens the Setpoint Schedule Pool dialog box and allows viewing, adding, editing, and printing of Setpoint Schedules details. You can save the selected SPS item to a file; open a SPS file and insert it into the pool; and download the selected SPS item to a controller's Setpoint Schedule pool.
<b><u>S</u>equences...</b>	Sequence configuration provides a series of inter-related events used to start-up or shut-down a unit process, or a series of timed and process measurement dependent events that are executed to produce a final product. This selection opens the Sequence Pool dialog box and allows viewing, adding, editing, and printing of Sequence details. You can save the selected SEQ item to a file; open a SEQ file and insert it into the pool; and download the selected SEQ item to a controller's Sequence pool.

## Recipes (Variables)

### Introduction

Each recipe consists of Variables, and carries its own unique recipe number and name for identification. (The names are descriptive references [aliases] and uniqueness is not enforced. Unique names are recommended to avoid operator confusion). The selected Variables were assigned during the Function Block Diagram Configuration.

It is possible to edit the setting of any recipe Variables through the Recipe Setup display at the operator interface. This means that an operator can adjust individual ingredient amounts in the recipe; but the ingredients (item's Variable Name), the order of the ingredients, and the recipe's number and name are under configuration control.

The recipe variable list is configured using the Hybrid Control Utilities application. An operator will be able to change individual item values through the Operator Interface.

For automatic loading of a setpoint profile in addition to other variables, a variable representing a profile number may be included in the recipe. This would also apply to a schedule or sequence number.

### Recipe Attributes

A recipe is a list of Variables with settings that define the ingredients needed to make a product or run a particular batch. The items represent Analog and/or Digital Points that were assigned in the Function Block Configuration and are identified by their Variable Names. Recipes have these basic attributes:

**Recipe Number** - A unique number must be assigned for each recipe that is configured. Numbers can be assigned in any sequence with gaps between numbers, but no two recipes can be given the same number.

**Recipe Name** - A descriptive name must be assigned consisting of letters or numbers with no spaces. Thus, a name can be any combination of letters and numbers without spaces. Note that lowercase letters are automatically converted to uppercase letters.

**Recipe Variables** - A list of Variables can be compiled for each recipe. A valid Variable and desired setting must be specified for each recipe item.

**Adjustable Settings** - The setting for an analog point can be any appropriate value from -99999 to 99999, and a digital point can be set in its ON or OFF state. It is possible to edit/change any recipe item/Variable Name setting through the "Edit Recipe" Setup dialog box during configuration.

### Recipe (Variables) Configuration Overview

A recipe is a list of Variables with settings that define the ingredients needed to make a product or run a particular batch. The items represent Analog and/or Digital Points that are assigned in the Function Block Configuration and are identified by their Variable Names.

#### Configuration Functions

Basic functions that you will use to configure a Recipe:

##### **Recipe Editor**

Create/Edit a Recipe under the File-New or File-Open menus. Accesses the Recipe Editor.

##### **Recipe Pool**

When you select "Recipes" from the Recipe menu, the "Recipe Pool " dialog box will be displayed. You can view Recipes in the pool. You can save a configuration's recipe to a file and then edit the recipe file. Allows you to view but not edit or create new recipes in the pool. You can save a configuration's recipe to a file and then edit that recipe file.

**Recipe Properties**

The Recipe Properties is merely a name assigned to the recipe, which will be added to the pool. You can also include a descriptor.

**Recipe Setup (EDIT)**

Recipe Set Up or Edit consists of selecting Variable names, assigning an analog value or digital state, and adding them to a list of Recipe items.

**Create/Edit Recipe (Variables) File**

Creates/edits a group of variables to be saved as a file (.RCP). File can be downloaded to the recipe pool. A recipe in the pool can later be edited or loaded into the controller's active configuration. The file assumes that the variables are in a certain order in the configuration. Make sure that this order is preserved when loading into a controller's active configuration. Changes to variables via deletions, renaming, or re-directing may affect the recipe content.

Step/Item	Action/Description
Select File, Open.	Lets you choose an .RCP file to edit. After selecting file the Recipe Editor appears.
OR	
Select File, New.	"Choose a new file type" box appears.
Select Recipes tab.	Recipe types appear.
Select Recipes (Variables).	The Recipe Editor appears.
THEN	
Select a Reference Configuration.	A recipe must have a configuration to give it context. Select an open configuration from the pull-down list. If none available, select Open Configuration to open one. The configuration will open. Click back to Recipe Editor and select the reference configuration.
Name and Description	Identify the recipe.
Variable Tag List	Lists all variable tags in the reference configuration. Click on a tag and click Add to add it to the recipe.
Recipe Items Name Value	Lists all variables in the recipe. Name of variable Value/state of variable. If analog variable, enter a value in the value field. If digital variable, select ON or OFF.
Delete	Deletes selected item from recipe.

Step/Item	Action/Description
Print	Prints the recipe
Save	Saves the recipe as .RCP file.
Download	Downloads recipe to the controller's recipe pool where it can be edited or loaded into the controller's active configuration.

## Recipe Pool

### Introduction

This is the recipe (variables) pool. The Recipe Pool lets you view a Recipe on a list of configured Recipes .

### Configuration

When you select "Recipes (Variables)" from the Recipes menu, the "Recipe Pool" dialog box will be displayed. From left to right the icons are:



#### PRINT a Recipe:

Click on a recipe name and then select the **Print** icon. The "Print" dialog box will appear. Select OK.

A recipe report will be printed with all the information entered on the "Recipe Properties" dialog box. [Variable, Description, Value or State]

#### SAVE a Recipe:

To save a recipe as a .rcp file, click on a recipe name and then select the Save icon. The "Save As" dialog box will appear.

#### DOWNLOAD a Recipe:

To download a recipe to the controller's recipe pool, click on the Download icon.

## Setup/Edit a Recipe in Pool

The "Edit Recipes" dialog box lets you view a recipe listed in the "Recipe Pool."

Make sure you have clicked on "Properties " and have given that specific recipe a name and description. See RECIPE POOL before proceeding.

### Procedure

Click on a recipe name in the active field and select "Recipe" or double click on the recipe name. The "Edit Recipe" dialog box will appear.

#### To ADD Variable to a Recipe:

Select a variable and click on ADD. A variable number will appear under "Recipe Items".

#### To DELETE a Variable from a Recipe:

Select a **variable number** from the "Recipe Items" field, then click "Delete".

#### To SET UP a Recipe Item

From the "Recipe Items" list, select a variable name from the list of recipe items.

If it is an **analog variable**, enter a **value** in the value field.

If it is a **digital variable**, select **ON or OFF**, from the drop-down menu in the Value field, as a digital state for the variable.

**Repeat this procedure** for each **recipe variable** desired for the recipe you are configuring.

**Click "OK"**. The length of the Recipe (number of variables) will appear in the "Recipe Pool".

**Click "CLOSE"** on the "Recipe Pool" dialog box to complete the configuration.

## Recipe Properties

The Recipe Properties dialog box contains fields for you to view:

- a recipe name .
- a descriptor of 16 characters.

## Setpoint Profiles

### Create/Edit Setpoint Profile File

Creates/edits a setpoint profile be saved as a file (.PRF). File can be downloaded to the setpoint profile pool. A profile in the pool can be edited or loaded into the controller's active configuration.

Step/Item	Action/Description
Select File, Open.	Lets you choose a .PRF file to edit. After selecting file the Profile Editor appears.
OR	
Select File, New.	"Choose a new file type" box appears.
Select Recipes tab.	Recipe types appear.
Select Setpoint Profile	The Profile Editor appears.
THEN	
Name and Description	Identify the profile.
Properties	This function lets you set the properties for the profile. The information configured here will appear in the Edit SP Profile dialog box.
Ramp Type Eng. Units Time Units Aux. Out Units Guar. Hold Type Guar. Hold High Guar. Hold Low	Properties of the profile. You can change these under Properties.
Add	Adds a step.
Insert	Inserts a step.
Delete	Deletes selected step.
Type	Ramp or Soak. A ramp segment is a starting setpoint and the time or rate to reach the setpoint of the following segment. Typically, segment #1 will be a ramp.

Step/Item	Action/Description
SP Value	Setpoint value set for Ramp (starting Setpoint value) and Soak (soak setpoint value).
Time/Rate	Ramp time is determined in either: TIME*-Hours or Minutes Range = 0.00 hr. to 999.99 hr. / 0.00 min. to 999.99 min. OR RATE*-EU/MIN or EU/HR Range = 0 to 999.99 *This selection of time or rate is made when you configure properties. Make this selection before entering any Ramp. NOTE: When Ramp unit is configured for TIME, entering "0" will imply an immediate step change in setpoint to the next soak.
Aux. Out	In addition to the main ramp and soak output value, a second analog value is available for each step of the profile. This output is a fixed soak value, which may be used to provide a setpoint value for a secondary control loop in the process. An example would be a ramp and soak temperature program combined with pressure setpoints for each step of the profile.
Guar. Hold	OFF or ON. Choose ON to hold the program if a process variable exceeds a predefined deviation from setpoint.
Events	You can configure 1 to 16 segment events to turn ON or OFF at the beginning of each segment. Segment events are digital switches that provide ON/OFF outputs through an SPEV control block. When a segment event is turned ON, it remains ON until the end of the segment at which time it is turned OFF unless it is configured to turn ON in the next segment. Note that segment events are not interrupted by soak time delays when the process variable is outside the guaranteed soak band. Events turn ON as soon as the previous segment is completed even if the process variable has not reached the soak setpoint. When the program completes, the events are held at current value until the programmer is returned to the ready state.
Print	Prints the profile.
Save	Saves the profile as .PRF file.
Download	Downloads profile to the controller's Setpoint Profile Pool where it can be edited or loaded into the controller's active configuration.

## Setpoint Profile Pool

### Introduction

The SP Profile Pool lets you view a profile on a list of configured profiles. Through this dialog box you will view the properties for each profile and set up or edit the information for each segment that make up a profile.

### Configuration

When you select “Setpoint Profiles” from the Recipes menu, the “Setpoint Profile Pool” dialog box will be displayed.

From left to right the icons are:



#### **PRINT a Profile:**

Click on a profile name and then select the **Print** icon. The "Print" dialog box will appear. Select OK.

A profile report will be printed with all the information entered on the tabs of the 'Setpoint Profile Properties' dialog box.

#### **SAVE a Profile:**

To save a Profile as a .prf file, click on a recipe name and then select the Save icon. The "Save As" dialog box will appear.

#### **DOWNLOAD a Profile:**

To download a Profile to the controller's Profile pool, click on the Download icon.

## Setup/Edit Setpoint Profile in Pool

### Introduction

The “Edit Setpoint Profile” dialog box lets you view profile segments for the programs listed in the “Setpoint Profile Pool.”

### View a program

Click on a profile name in the active field and select the **Edit Item** Icon from the **Toolbar** on the dialog box  or double click on the profile name.

The “Edit Setpoint Profile Segments” dialog box will appear. It presents multiple segments at a time to view. Click on field for drop down menu to appear for some selections.

### Edit Setpoint Profile Segments Dialog Box

The three main areas on the “Edit Setpoint Profile Segments” dialog box are:

#### *Properties Information Area*

This block of information was developed during “Properties” configuration. It lists the selection and values that were made on the “Setpoint Profile Properties” tab cards. These fields are read only; they are for reference only.

#### *Profile Data Entry area*

This data entry area lets you make selections.

#### *Profile Segment Setup Buttons*

View only.

### Profile Setup/Edit Procedure

The Profile Setup/Edit Procedure consists of building a ramp/soak profile by entering a value or make a selection for each of the following fields. View only.

- adding or inserting segments to a list of segment
- selecting the type of segment—Ramp or Soak (drop-down menu)
- selecting Guaranteed Soak (On or Off) for soak segments, if desired (drop-down menu)
- entering the Setpoint value for the ramp or soak
- entering the value of the time or ratio for the segment
- selecting an Aux. Out value (if required) for the segment
- selecting the events (1 - 16) you want turned on or off at the beginning of the segment (drop-down menu)
- repeating the procedure for all the segments in the program

## Setpoint Profile Properties

### Introduction

This function lets you view the properties for the program selected in the Setpoint Profile Pool.

### Parameters

Refer to the table below for properties.

Parameter	Parameter Description
<b>TEXT</b>	
Label	Profile Name
Descriptor	Description of Profile
Primary Output Label	Primary Output Descriptor Name.
Primary Output Engineering Units	Primary Output Engineering Units descriptor
Auxiliary Output Label	Auxiliary Output Descriptor name
Auxiliary Output Engineering Units	Auxiliary Output Engineering Units descriptor
<b>GENERAL</b>	
<b>Ramp Type</b>	
<i>Rate</i>	Each ramp segment's time specifies the RATE at which that

<b>Parameter</b>	<b>Parameter Description</b>
	profile's output will reach the next segment.
<i>Time</i>	Each ramp segment's time is the TIME allotted to the profile's output to reach the next segment's value in hours or minutes.
<b>Guaranteed Hold Type</b>	
<i>None</i>	No guaranteed hold if a PV deviates a specified amount above or below the profile output.
<i>Per Segment</i>	Lets you select specific segments for guaranteed soak where you set up the profile ramps and soaks.
<i>All Soaks</i>	All soaks will have a guaranteed soak.
<i>All Segments</i>	All segments will have a guaranteed soak
<b>Time Units</b>	
<i>Hours</i>	This selection assigns the time units of all segments in HOURS.
<i>Minutes</i>	This selection assigns the time units of all segments in MINUTES.
<b>Guaranteed Hold High</b>	A Number in Engineering Units above the setpoint outside of which the timer halts
<b>Guaranteed Hold Low</b>	Enter a Number in Engineering Units below the setpoint outside of which the timer halts.
<b>LOOP/JOG</b>	
<b>Jog Segment</b>	Segment number jog will go to.
<b>Loop</b>	
<i>Start Segment</i>	This designates the number of the first segment of the loop.
<i>End Segment</i>	This designates the number of the last segment of the loop. The last segment of a program must be a soak segment. Last segment of a loop can be a ramp or soak.
<i>Cycles</i>	This number lets the program repeat (loop) a specified number of time from beginning to end.  An entry of 0 will cause an indefinite loop.
<b>START/RESTART</b>	The Restart Rate value is used to return the process to the last operating

Setpoint Profiles  
Setpoint Profile Properties

---

Parameter	Parameter Description
Restart Rate	setpoint prior to power loss when restart input is connected to power off timing block.

Click on the tab to access the properties for that tab.

Click on the profile name in the Setpoint Profile Pool and select the Edit Segments Icon (3rd from left) from the Toolbar on the dialog box.

## Setpoint Schedules

### Create/Edit Setpoint Schedule file

Creates/edits a setpoint schedule be saved as a file (.SCH). File can be downloaded to the setpoint schedule pool. A schedule in the pool can be edited or loaded into the controller's active configuration.

Step/Item	Action/Description
Select File, Open.	Lets you choose a .SCH file to edit. After selecting file the Schedule Editor appears.
OR	
Select File, New.	"Choose a new file type" box appears.
Select Recipes tab.	Recipe types appear.
Select Setpoint Schedule.	The Schedule Editor appears.
THEN	
Select a Reference Configuration.	A schedule must have a configuration to give it context. Select an open configuration from the pull-down list. If none available, select Open Configuration to open one. The configuration will open. Click back to Schedule Editor and select the reference configuration.
Name and Description	Identify the schedule.
Properties	Sets properties for the schedule, such as time units and guaranteed hold limits.
Time	Length of time for the segment.
SP1-SP8	Setpoint values. For ramp segments these are the starting values.
Events 1-16	Segment events are digital switches that provide ON/OFF output through an SPS function block. When a segment event is turned ON, it remains on until the end of the segment at which time it is turned OFF unless it is configured to turn ON in the next segment. Select from the drop down menu which events you want to turn ON or OFF at the beginning of each segment.
Aux1-Aux8	The auxiliary block supports up to 8 soak only outputs. You can assign values to all eight Auxiliary Outputs for each segment.

Step/Item	Action/Description
GHold1-GHold8	Setpoint guarantee is provided for the master block setpoints with a single symmetrical value for each setpoint output. Actions for the guarantee soak may be set on a per segment basis for OFF, HIGH setpoint deviation, LOW setpoint deviation or both HIGH and LOW setpoint deviations. Click on an active field and select a GHOLD Type from Drop-down menu: OFF - No Guaranteed Hold HIGH setpoint deviation - The schedule will hold if a PV deviates above the Setpoint value set. LOW setpoint deviation - The schedule will hold if a PV deviates below the Setpoint value set on the "Setpoint Schedule Properties" dialog box. HIGH and LOW setpoint deviations - The schedule will hold if a PV deviates above or below the Setpoint value set on the "Setpoint Schedule Properties" dialog box.
Recycle Segment	The segment number at which a recycle will start. Enter a value 0 to 50
Recycle Count	This number lets the schedule repeat (loop) a specified number of times. Enter a value 0-999 or 0 for infinite.
Delete	Deletes selected item from schedule.
Print	Prints the schedule.
Save	Saves the schedule as .SCH file.
Download	Downloads schedule to the controller's schedule pool where it can be edited or loaded into the controller's active configuration.

## Setpoint Schedule Pool

### Introduction

The SP Schedule Pool lets you view a schedule on a list of configured schedules.

### Configuration

When you **select "Setpoint Schedules" from the Recipe menu**, the "Setpoint Schedule Pool" dialog box will be displayed.

From left to right the icons are:



#### **PRINT a Schedule:**

Click on a schedule name and select the **Print** icon. The "Print" dialog box will appear. Select OK.

A profile report will be printed with all the information entered on the tabs of the "Setpoint Schedule Properties" dialog box.

**SAVE a Schedule:**

To save a Schedule as a .sch file, click on a recipe name and then select the Save icon. The "Save As" dialog box will appear.

**DOWNLOAD a Schedule:**

To download a Schedule to the controller’s Schedule pool, click on the Download icon.

## Setup/Edit Setpoint Schedule in Pool

### Introduction

The “Edit Schedule” dialog box lets you view a schedule from the schedules listed in the “Setpoint Schedule Pool.”

### Edit a Schedule

Click on a schedule name in the active field and select the **Edit Segments** Icon (3rd from left) from the **Toolbar** on the dialog box or double click on the schedule name.

The “**Edit Schedule Segments**” dialog box will appear with the selected Schedule indicated on the top banner. The Hybrid Control Utilities presents multiple segments at a time to view.

Parameter	Parameter Description
Time	Length of time for the segment Time Units were selected in the “ <u>Setpoint Schedule Function Block Properties</u> ” Dialog Box
Setpoint Values	Setpoint 1 through Setpoint 8
Ghold Type [Ghold1 thru Ghold8]	Setpoint guarantee is provided for the master block setpoints with a single symmetrical value for each setpoint output. Actions for the guarantee soak may be set on a per segment basis for OFF, HIGH setpoint deviation, LOW setpoint deviation or both HIGH and LOW setpoint deviations.
	OFF - No Guaranteed Hold
	HIGH setpoint deviation The schedule will hold if a PV deviates above the Setpoint value set.
	LOW setpoint deviation The schedule will hold if a PV deviates below the Setpoint value set on the “Setpoint Schedule Properties” dialog box.
	HIGH and LOW setpoint deviations The schedule will hold if a PV deviates above or below the Setpoint value set on the “Setpoint Schedule Properties” dialog box.
Auxiliary Outputs [Aux1 thru Aux8]	The auxiliary block supports up to 8 soak only outputs. You can assign values to all eight Auxiliary Outputs for each segment.

Parameter	Parameter Description
Recycle Segment	The segment number at which a recycle will start
Recycle Count	This number lets the schedule repeat (loop) a specified number of times.
Events [Events 1 thru 16]	Segment events are digital switches that provide ON/OFF output through an <u>SPS function block</u> . When a segment event is turned ON, it remains on until the end of the segment at which time it is turned OFF unless it is configured to turn ON in the next segment.

## Setpoint Schedule Properties

### Introduction

This function lets you view the properties for the schedule selected in the Setpoint Schedule Pool. If you are adding a schedule, this dialog box will automatically appear. It will also appear if you select the **Worksheet Properties** Icon (2nd from left) from the **Toolbar** on the dialog box. The information configured here will appear in the "Edit Schedule Segment" dialog box.

Parameter	Parameter Description
<b>General</b>	
<b>Label</b>	Schedule Name
<b>Descriptor</b>	Description of schedule
<b>Jog Seg</b>	Logic input (JOG) on state switch block will cause the schedule to jump to the start of the segment designated then continue.
<b>Time Units</b>	This selection assigns the time units (hours <b>or</b> minutes) for all segments.
<b>Hours</b>	Time unit in Hours
<b>Minutes</b>	Time unit in Minutes
<b>Guaranteed Hold Limit</b>	The schedule will hold if a PV deviates above or below (or both) the Setpoint value set here.  Select Guaranteed Hold Type on the "Setpoint Edit Schedule" dialog box.

## Sequences

### Create/Edit Sequence File

Creates/edits a sequence be saved as a file (.SEQ). File can be downloaded to the sequence pool. A sequence in the pool can be edited or loaded into the controller's active configuration.

Step/Item	Action/Description
Select File, Open.	Lets you choose a .SEQ file to edit. After selecting file the Sequence Editor appears.
OR	
Select File, New.	"Choose a new file type" box appears.
Select Recipes tab.	Recipe types appear.
Select Sequence.	The Sequence Editor appears.
THEN	
Select a Reference Configuration.	A sequence must have a configuration to give it context. Select an open configuration from the pull-down list. If none available, select Open Configuration to open one. The configuration will open. Click back to Sequence Editor and select the reference configuration.
Name and Description	Identify the sequence.
Properties	Sets properties for the sequence, such as jog step and time units.
Add	Adds a step to the sequence.
Time	Length of time for the segment.
SP1-SP8	Setpoint values at the start of the segment.
State	State number for each step of the sequence. A state may be selected multiple times in the sequence. Since time is an attribute of the sequence, the state may be activated for a different time period each time it is selected. (The order does not have to be sequential). Enter a State Number in each active field. States are numbered from 1 to 50.
State name	Name of current state. Enter a state name (12 character max.) Examples: Heating, Cooling, Mixing.

Step/Item	Action/Description
Time in Step	Time duration value for each step of the sequence. Time units can be changed under Properties.
Time in Next Step	Designates the step the sequence will advance to when the time expires. It can be any step in the sequence, including steps that have been previously executed. Enter 0 to stop the sequence after current step expires and to hold the outputs.
Event Signal #1	Click on the Event Signal #1 field and from the drop-down menu, select the event you want signal #1 to represent.
Event 1 Next Step	Each state of the sequence can also be configured to accept two different events to terminate the step. Whichever occurs first—an Off-to-On (rising edge) transition of either event signal OR elapsed step time—will cause the sequence to advance to the appropriate next step. Enter a value for Event 1 Next Step.
Event Signal #2	Click on the Event Signal #2 field and from the drop-down menu, select the event you want signal #2 to represent.
Event 2 Next Step	Each state of the sequence can also be configured to accept two different events to terminate the step. Whichever occurs first—an Off-to-On (rising edge) transition of either event signal OR elapsed step time—will cause the sequence to advance to the appropriate next step. Enter a value for Event 2 Next Step.
Advance Next Step	Allows you to select an appropriate action for the manual advance OI action or function block digital advance input. Enter a value.
Aux. Value	Enter an analog output value associated with each state.
Delete	Deletes selected step from sequence.
Print	Prints the sequence.
Save	Saves the sequence as .SEQ file.
Download	Downloads sequence to the controller's schedule pool where it can be edited or loaded into the controller's active configuration.

## Sequence Pool

### Introduction

The Sequence Pool lets you add or delete a Sequence on a list of configured Sequences and also enter the "Properties" function and the "Edit Sequence " function to set up each Sequence.

### Configuration

When you **select "Sequences" from the Recipes menu**, the "Sequence Pool" dialog box will be displayed. From left to right the icons are:



#### **PRINT a Sequence:**

Click on a sequence name and then select the **Print** icon. The "Print" dialog box will appear. Select OK.

A sequence report will be printed with all the information entered on the "Sequence Properties" dialog box. [Label, Description, Jog Step, and Time Units in Hours or Minutes]

#### **SAVE a Sequence:**

To save a sequence as an .seq file, click on a recipe name and then select the Save icon. The "Save As" dialog box will appear.

#### **OPEN a Sequence:**

To open a previously saved .seq file and insert it into the pool, click on the Open icon.

#### **DOWNLOAD a Sequence:**

To download a sequence to the controller's sequence pool, click on the Download icon.

## Setup/Edit Sequence in Pool

### Introduction

The "Edit Sequence" dialog box lets you set up or edit a sequence from the sequences listed in the "Sequence Pool" dialog box.

Make sure you have clicked on "Edit Properties" toolbar icon and have configured the properties for that specific Sequence.

### Edit a Sequence

Click on a Sequence name in the active field and select the **Edit Item** Icon (3rd from left) from the **Toolbar** on the dialog box or double click on the Sequence name.

The "**Edit Sequence**" dialog box will appear with the selected Sequence indicated on the top banner. Several Steps are shown for viewing and editing.

Each step contains the following Step attributes:

Parameter	Parameter Description	Entry Information
<b>State Number</b>	State number for each step of the sequence. A state may be selected multiple times in the sequence. Since time is an attribute of the sequence, the state may be activated for a different time period each time it is selected. (The order does not have to be sequential)	Enter a State Number in each active field. States are numbered from 1 to 50

Parameter	Parameter Description	Entry Information
<b>State Name</b>	Name of current state	N/A
<b>Time in Step</b>	Time duration value for each step of the sequence.  Time Units are selected on the Sequence Properties dialog box	Enter values for all Steps in the appropriate fields.
<b>Time Next Step</b>	Designates the step the sequence will advance to when the time expires. It can be any step in the sequence, including steps that have been previously executed.	Enter a number for the next step when time expires on current step. Enter 0 to stop the sequence after current step expires and to hold the outputs.
<b>Event Signal #1</b>	The event signal is a digital signal defined in the sequencer block. When Event Signal #1 signal transitions from FALSE to TRUE the sequence will jump to the step defined in Event 1 Next Step.	N/A
<b>Event 1 Next Step</b>	An off-to-on (rising edge) transition of Event Signal #1 will cause the sequence to advance to the step specified here.	Enter a value for Event 1 Next Step.
<b>Event Signal #2</b>	The event signal is a digital signal defined in the sequencer block. When Event Signal #2 signal transitions from FALSE to TRUE the sequence will jump to the step defined in Event 2 Next Step.	N/A
<b>Event 2 Next Step</b>	An off-to-on (rising edge) transition of Event Signal #2 will cause the sequence to advance to the step specified here.	Enter a value for Event 2 Next Step.
<b>Advance Next Step</b>	Allows you to select an appropriate action for the manual advance OI action or function block digital advance input	Enter an "Advance Next Step" value.
<b>Aux Value</b>	Enter an analog output value associated with each state.	Enter an analog output value.

## Sequence Properties

### Introduction

This function lets you set the properties for the sequence selected in the Sequence Pool. If you are adding a Sequence, this dialog box will automatically appear. It will also appear if you select the **Worksheet Properties** Icon (2nd from left) from the **Toolbar** on the dialog box. The information configured here will appear in the "Edit Sequence" dialog box.

### Configuration

Refer to the table below and enter the properties information in the appropriate fields in the dialog box, then click "OK" to return to the "Sequence Pool" dialog box.

Parameter	Parameter Description	Entry Information
<b>General</b>		
<b>Label</b>	Sequence Name	6 characters
<b>Descriptor</b>	Description of Sequence	16 characters
<b>Jog Step</b>	Logic input (JOG) on state switch block will cause the Sequencer to jump to the start of the step designated then continue.	Step number jog will go to
<b>Time Units</b>	This selection assigns the time units (hours or minutes) for all Steps.	
<b>Hours</b>	Time unit in Hours	Click on Radio button
<b>Minutes</b>	Time unit in Minutes	Click on Radio button



## On-Line Monitoring

### Overview

Hybrid Control Utilities Monitoring provides the following:

**Multiple, concurrent function block Monitor Windows**

You can open as many Function Block monitor windows as you want until you run out of physical resources on the PC

You can open Function Block monitor windows concurrently for Function Blocks on different Function Block Diagram Worksheets

Function Block monitor window can be resized to better suit concurrent windows

**Provides a Watch Window** to view groups of related data such as I/O and Signal Tags

**Allows Monitoring to cross all FBD worksheet boundaries**

There are no boundaries

You can call up Function Block monitor windows from any or all FBD worksheets concurrently

The Watch Window implicitly crosses all worksheets

All other diagnostic windows can also be open concurrently

Select "Monitor Mode" from the "Monitor" menu or select the "Monitor" icon from the Main Toolbar



You can specify the monitor update rate that determines how often data is collected from the controller during monitoring. This update rate can be set to either 1/4 second, 1/2 second, 1 second, or 5 seconds.

See "Monitor Toolbar" for the available Monitoring and Diagnostic Windows.

See "Visual Indicators for Monitor Mode" for on-line monitoring indicators.

## Enter Monitor Mode

Select "Monitor Mode" from the "Monitor" menu or select the "Monitor" icon from the Main Toolbar.



**While in monitor mode, edits to the configuration cannot be made.**

### Procedure

Selecting this menu item opens the "Enter Monitor Mode" dialog box.

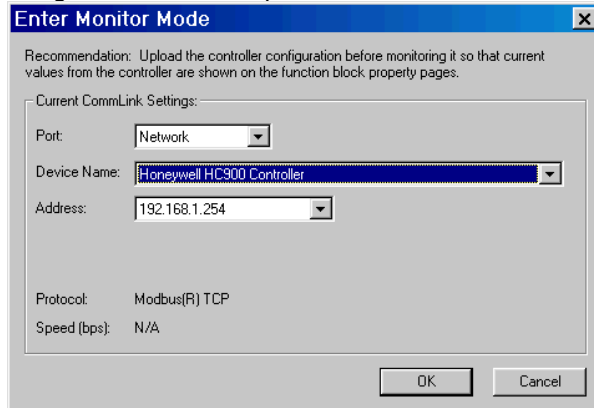

Select the controller to monitor using the Port and Address fields on this dialog. The dialog box also indicates the Protocol and Baud rate for the selected controller.

Click the OK button on this dialog to enter monitor mode for this configuration.

The background of the function block diagram worksheet changes to yellow and the cursor includes the Monitor icon [Eye] with the arrow.

See "[Visual Indicators for Monitor Mode](#)".

The [Monitor Toolbar](#) will appear, whose buttons you can use to toggle (show or hide) the various monitor windows. These windows can also be toggled using menu items on the Monitor menu.

When exiting monitor mode, any monitor windows still open will be closed and will be re-opened at their same positions when monitor mode is re-entered for this configuration.

## Visual Indicators for Monitor Mode

When "Monitor Mode" is selected there are several indications that the configuration is in Monitor Mode.

The "Connected" indicator on the Status Bar will blink to show that the controller, whose name appears next to it, is being monitored. 

The cursor changes to include the Monitor icon [Eye] along with the arrow.

3. The word **<Monitoring>** appears in the configuration Title Bar at the top of the diagram.

4. The background color of the Function Block Diagram changes to **YELLOW**.

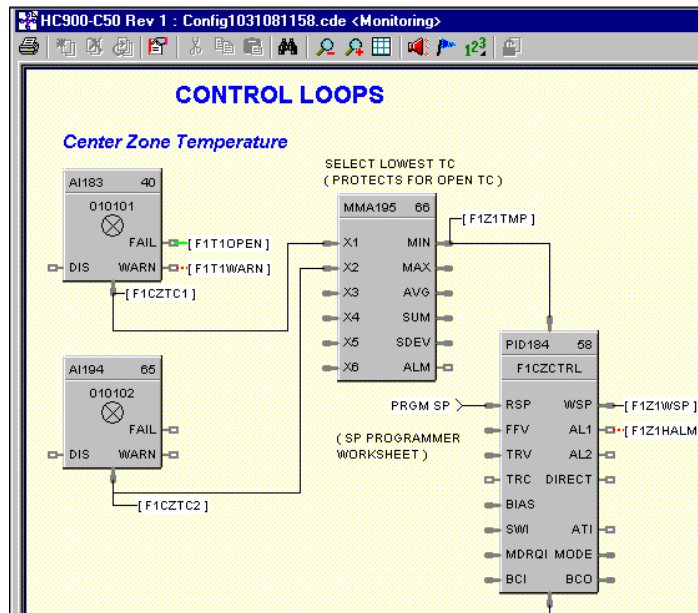

## Monitor Update Rate

### Introduction

You can specify the monitor update rate that determines how often data is collected from the controller during monitoring. This update rate can be set to either 1/4 second, 1/2 second, 1 second, or 5 seconds.

This option is **allowed only during edit mode**, not while you are monitoring the controller. The default monitor update rate is 1 second and this update rate is remembered between sessions of the software.

If you want to monitor from a relatively slow computer set the monitor update rate to a slow setting.

### Procedure

Select "Set Update Rate" from the "Monitor" menu on the Main Drop-down menus.

Select an Update Rate from the Sub-menu:





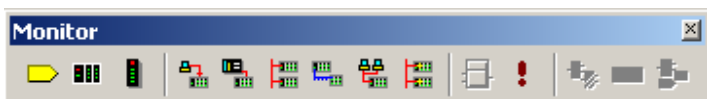







- 1/4 Second
- 1/2 Second
- 1 Second, or
- 5 seconds



## Monitor Toolbar



Click on **ICON** to open a dialog box. More than one dialog box can be open at a time.

The Monitor Toolbar toggles monitor windows for the following:

ICON	Function	Window Comments
	<b>Watch Summary</b>	Toggles the Watch Summary Window that lets you view groups of related data such as I/O and Signal Tags.
	<b>Controller Diagnostics</b>	Toggles the Controller Diagnostics Window that lets you view the controller parameters and values.
	<b>Rack Diagnostics</b>	Toggles the I/O Rack Diagnostics window that lets you view the Rack Diagnostics, Expansion I/O Comm Diagnostics(except C30 CPU), and the I/O Module diagnostics.
	<b>Serial S1 Port Diagnostics</b>	Opens the Serial Port S1 (RS232 Default) Configuration Port Diagnostics window that lets you view the parameters and values of the S1 port (default R2-232) on the controller.
	<b>Serial S2 Port Diagnostics</b>	Toggles the Serial Port S2 (RS485 default) OI Port Diagnostics window that lets you view the S2 port (default RS485 Operator Interface) parameters and values.
	<b>Network Port Diagnostics</b>	Toggles the Network Port Diagnostics window that lets you view the network port parameters and values.
	<b>Expansion I/O Comm Diagnostics (except C30 CPU)</b>	Toggles the Expansion I/O Comm Diagnostics window that lets you view the expansion port parameters and values.
	<b>Host Connections Diagnostics</b>	Toggles the Host Connections window that lets you view the host connections parameters and values.
	<b>Peer-to-Peer Diagnostics</b>	Toggles the Peer-to-Peer Connections Diagnostics window that lets you view the Peer-to-Peer parameters and values.
	<b>Function Block Monitor</b>	Toggles the Monitor Function Block window that lets you monitor key parameters of the selected Function Block.
	<b>Forced Blocks Window</b>	Toggles the Forced Block Summary Window Window that lets you see all the function blocks that have forced outputs.
	<b>All Function Block Windows</b>	Lets you toggle the function block windows that are open - Display or Hide

ICON	Function	Window Comments
	<b>All Pins</b>	Lets you toggle (display/hide) monitoring values (numeric or On/Off state) at all input and output pins that are shown.
	<b>All Monitor Windows</b>	Lets you toggle the Monitor windows that are open - Display or Hide.

## How Do I Start Monitoring

### Procedure

Either upload the configuration from the controller to your PC or Open the file from disk that matches what's in the controller. Hybrid Control Utilities will inform you if the file you opened is not currently loaded in the controller. In this case, limited monitoring capabilities will be available. For example, you won't be able to monitor function blocks or bring up the Watch Summary Window.

Press the MONITOR button on the main toolbar.



The "Enter Monitor Mode" dialog box will open.

**Note:** *While in monitor mode, you won't be able to edit the configuration. For example, you won't be able to add or delete function blocks, move items on the Function Block Diagram, or change configuration parameters of function blocks on their property pages. You will, however, be able to view the configuration parameters of function blocks on their property pages, but these values aren't being read from the controller. They exist only in the configuration open in Hybrid Control Utilities. That is why it is recommended that you perform an upload from the controller before monitoring so that current values from the controller are shown on the function block property pages."*

Select the Comm port and controller address to monitor. Press OK.

It checks to see if information is the same in the controller.

The feedback will be the monitor toolbar.

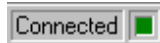
The Status Bar shows  on bar indicates that monitor mode is in effect. The green square is an activity indicator and flashes bright green when requests for monitored data are made to the controller.

There is also the word "Monitoring" indicated on the banner of the worksheet, the FBD worksheet background turns yellow and an eye appears with the cursor arrow.

See "Visual Indicators for Monitor Mode" for on-line monitoring indicators.

### Right Click Procedure in Monitor Mode

Depending where you right-mouse click on the FBD worksheet during monitoring, the resulting menu will have some differences.

Below each item in red is shown the menu items that appear when you right-click on that item on your FBD during Monitor Mode.

Right click on these						
	Function Block	Variable	Yellow Space	Signal Tags	Connectors	Page Connectors
To see these choices	<a href="#">Monitor Block</a>	<a href="#">Monitor Block</a>	<a href="#">Execution Order</a>	<a href="#">Watch Summary</a>	<a href="#">Watch Summary</a>	<a href="#">Watch Summary</a>
	<a href="#">Watch Summary</a>	<a href="#">Watch Summary</a>	<a href="#">Fast Logic Order</a>	<a href="#">Add to Watch Summary</a>	<a href="#">Add to Watch Summary</a>	<a href="#">Add to Watch Summary</a>
	<a href="#">Monitor Pins</a>	<a href="#">Add to Watch Summary</a>	<a href="#">Find</a>	<a href="#">Monitor Pins</a>	<a href="#">Monitor Pins</a>	<a href="#">Monitor Pins</a>
	<a href="#">Help</a>	<a href="#">Monitor Pins</a>	<a href="#">Go To</a>	<a href="#">Help</a>	<a href="#">Help</a>	<a href="#">Help</a>
	<a href="#">Execution Order</a>	<a href="#">Help</a>	<a href="#">View</a>	<a href="#">Find Where Used</a>	<a href="#">Find Where Used</a>	<a href="#">Find Where Used</a>
	<a href="#">Copy</a>	<a href="#">Execution Order</a>	<a href="#">Properties (File)</a>	<a href="#">Properties (Signal Tag)</a>	<a href="#">Properties (Connector)</a>	<a href="#">Properties</a>
	<a href="#">Properties (Function Block)</a>	<a href="#">Copy</a>				
		<a href="#">Properties (Function Block)</a>				

Right click on these			
	Input Pins	Output Pins	Wire Node
To see these choices	<a href="#">Trace</a>	<a href="#">Monitor Pins</a>	<a href="#">Help</a>
	<a href="#">Monitor Pins</a>		

## Function Block Monitor Window

The Hybrid Control Utilities provides live monitoring of all Function Blocks.

To access, select "Monitor Function Block" from the "Monitor" menu or from the Monitor toolbar.



Or

Right Click a function block or variable in Monitor Mode and select the Monitor Block menu item.

The summary will provide status of the parameters shown in the list.

For "Loop" blocks, the current mode will be shown in the lower right of the window

LSP AUTO = Local Setpoint, Automatic Output

LSP MAN = Local Setpoint, Manual Output

RSP AUTO = Remote Setpoint, Automatic Output

RSP MAN = Remote Setpoint, Manual Output

To change Mode settings of a loop block, click on a radio button to select

*Local or Remote Setpoint*

*Automatic or Manual Output*

Click the "Change Mode" button to change the mode.

### Changing a Parameter

Some blocks allow you to change some parameters. Click on a parameter name, if allowed the "Write" field will become active. Enter an override value in the field.

### Channel/Sensor Status

I/O blocks display a parameter called Channel/Sensor Status to indicate any abnormalities. See I/O Channel/Sensor Status for details.

Click on "X" to exit box.

**Attention:** All function blocks dialog boxes have a "MONITOR" button when in Monitor mode that will access this window.

Below is an example of a Monitor Window for a PID block.

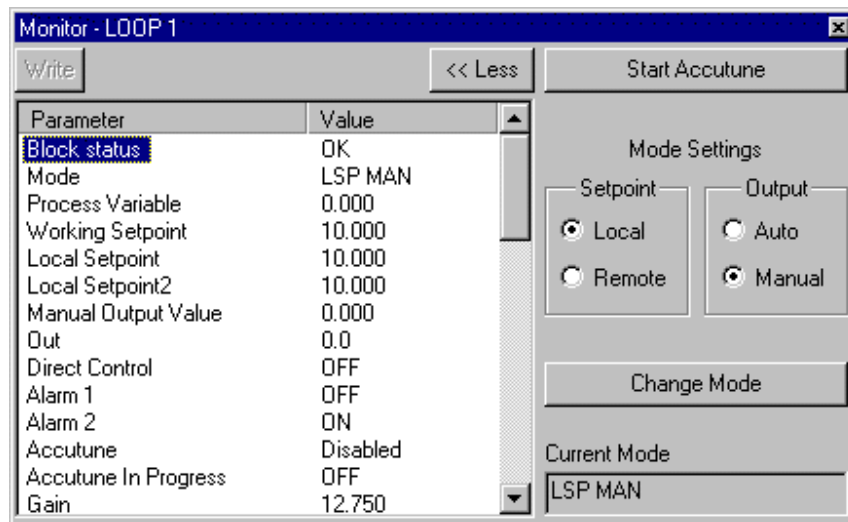

## Forced Blocks Window

The Hybrid Control Utilities lets you see all the function blocks that have forced outputs .

Select "Forced Blocks" from the "Monitor" drop-down menu or from the Monitor toolbar.



(This window can be launched from the "Utilities Worksheet"

The "Forced Blocks" dialog box will appear.

The summary shows a list of Block I.D.s that have a forced output pin.



Click on "X" to close the box.

## How Do I Stop Monitoring

Press the MONITOR button on the main toolbar.



This will return the associated configuration to VIEW mode.

Feedback will be the monitor button (unpressed), and all open monitor windows will disappear. The FBD Worksheet background returns to white and the eye disappears from the cursor.

**Attention:** If you return from VIEW mode to Monitor mode, all your previously opened monitor windows will appear (if the same configuration)

## Logic Flow

### Overview

In Monitor Mode, Logic Flow is shown within the Configuration Worksheet Monitor Window.

Soft Wires are identified to represent the Logic state at the pin of the source in monitor mode.

Function Block pin values can be monitored briefly or you can stick the values on display until you dismiss them. Analog Values are in decimal format and Digital States are On/Off.

Digital Signal Tags and corresponding Connectors at the block pins include color-coded representations for state changes.

Page Connectors include color-coded representations for state changes.

Logic Inversion indicators are pictorially identified on the block and are color-coded to identify logic states impeding or permitting logic flow.

### CAUTION

During Live-Monitoring (especially fast scan), it is possible to see transient states where the block output is inconsistent with its input values. This occurs because it is possible for the input values and outputs values to be taken from different controller execution cycles. Therefore, either the viewed inputs or outputs may be "older". Logic monitoring is appropriate for static conditions.

### Soft Wire Identification

Solid/Green = On, Dotted/Red = Off

Logic State at the Output Pin = ON

The Digital Signal Tag and its corresponding Connector/Page Connector will have the entire length of its tail drawn in solid GREEN.

Logic State at the Output Pin = OFF

The Digital Signal Tag and its corresponding Connector/Page Connector will have the entire length of its tail drawn in dashed RED.

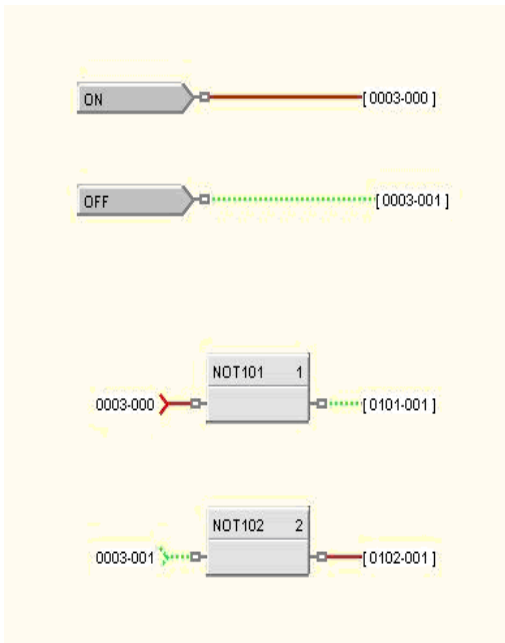

Solid/Red = On, Dotted/Green = Off

Logic State at the Output Pin = ON

The Digital Signal Tag and its corresponding Connector/Page Connector will have the entire length of its tail drawn in solid RED.

Logic State at the Output Pin = OFF

The Digital Signal Tag and its corresponding Connector/Page Connector will have the entire length of its tail drawn in dotted GREEN.

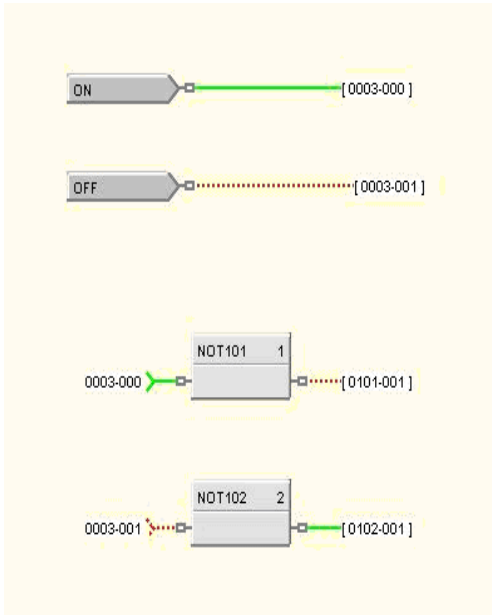

### Signal Tags and Connectors/Page Connectors

Digital Signal Tags and Connectors/Page Connectors include color-coded representations for state changes as substitutes for soft-wires. To select one of the following color schemes, go to Monitor menu, then [Set Logic State Colors](#).

#### Solid/Green = On, Dotted/Red = Off

Logic State at the Output Pin = **ON**

The Digital Signal Tag and its corresponding Connector/Page Connector will have the entire length of its tail drawn in solid GREEN.

Logic State at the Output Pin = **OFF**

The Digital Signal Tag and its corresponding Connector/Page Connector will have the entire length of its tail drawn in dashed RED.

#### Solid/Red = On, Dotted/Green = Off

Logic State at the Output Pin = **ON**

The Digital Signal Tag and its corresponding Connector/Page Connector will have the entire length of its tail drawn in solid RED.

Logic State at the Output Pin = **OFF**

The Digital Signal Tag and its corresponding Connector/Page Connector will have the entire length of its tail drawn in dotted GREEN.

## Displaying Function Block's Pin Values

Function Block pin value(s) can be monitored **briefly** and you can set one or all of the values on display (**constant display**) until you dismiss them. Analog Values are in decimal format and Digital States are On/Off.

### Displaying a Single Pin Value

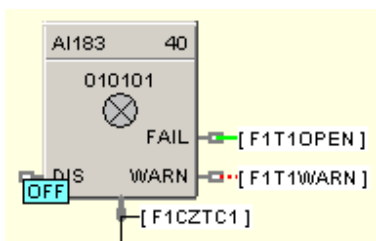

### Displaying Briefly

Hover the cursor over any pin momentarily. The pin's value will be displayed next to the pin as long as the cursor remains motionless over the pin.

To **remove** the briefly displayed value:  
remove the cursor from the pin.

### Displaying Until Dismissed (Constant Display)

Hover the cursor over any pin and left-click while the pin value is displayed, or right-click and select "Monitor Pins" from the menu.

To **remove** the constantly displayed value:  
left-click on the pin again, or  
right-click and select "Monitor Pins" again from the menu.

### Displaying All Function Block Pin Values

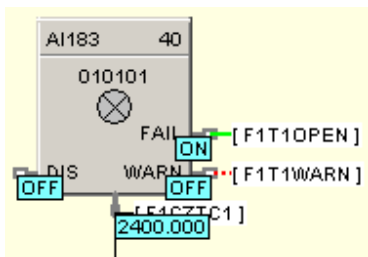

### Displaying Briefly

Hover the cursor over the interior of a function block momentarily. All of the Function Blocks pin values will be displayed next to the pins as long as the cursor remains motionless over the block.

To **remove** the briefly displayed values:  
remove the cursor from the block.

### Displaying Until Dismissed

Hover the cursor over the interior of a function block and left-click while the pin values are displayed, or right-click and select "Monitor Pins" from the menu.

To **remove** the constantly displayed value:  
left-click on the pin again, or  
right-click and select "Monitor Pins" again from the menu.

### toggling All Pin Values on Worksheet



Select  on the Monitor Toolbar or select "Monitor Pins" from the Monitor menu.

**NOTE:** Any pin values shown when monitor mode is exited will be re-shown when Monitor mode is re-entered. This only applies to the current session of the application and not between sessions of the application.

### Logic Inversion Color Codes

Logic Inversion indicators are pictorially identified on the block and are color-coded to identify logic states impeding or permitting logic flow.

#### Logic Blocks Inversion Indicators

**RED = OFF**  
**GREEN = ON**

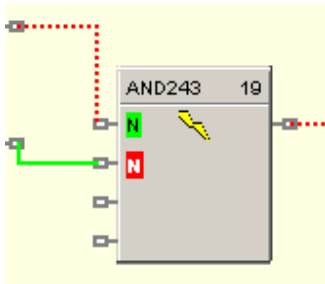

#### Digital Input Blocks Inversion Indicators

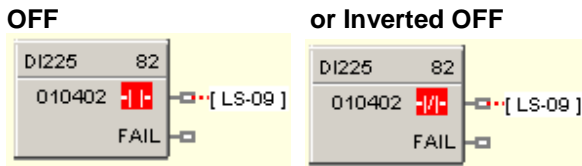
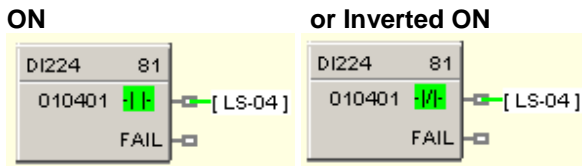

#### Digital Output Blocks Inversion Indicators

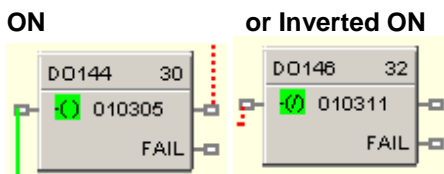

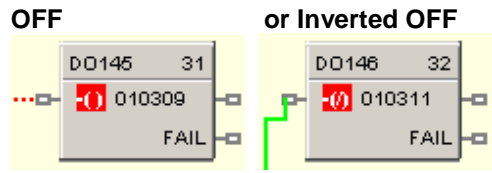

## Watch Summary Window

### Watch Summary Window

#### Overview



accesses the Watch Summary Window from the Monitor Toolbar

Or, the menu item "Watch Summary" from the Monitor Menu on the main menu.

This is a view of the Watch Summary Window. It is a Dockable (movable), sizable window.

[Press and hold the CTRL key down to prevent Docking when moving the window]

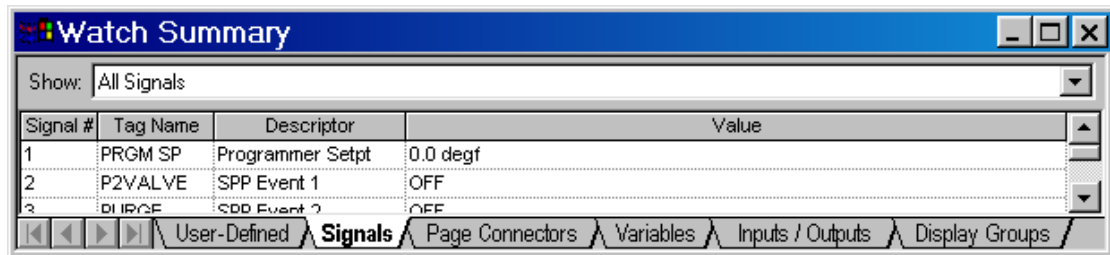

There are five tabs at the bottom of the window that lets you monitor the following groups of data from the controller. Click on any of the tab titles below **to view an example** of the selected data for that tab. All parameter listings may be **sorted** by column.

User Defined (Customized list of Variables, Signal Tags, Page Connectors)

Signals (can be filtered by type - All, Analog, Digital)

Page Connectors (can be filtered by type - All, Analog, Digital)

**Variables** (can be filtered by type - All, Analog, Digital)

I/O (can be filtered by type - AI, AO, DI, DO)

OI Display groups (Overviews, Panel Meters, Alarms, Trends, etc)

#### Docking and Undocking the Window

Double clicking in the Title Bar area of the Watch Summary Window will toggle its docked state. If the window is docked, double clicking in the title bar area will undock the window.

If the window is Undocked

- double-clicking in the title bar area will dock the window at it last docked position
- Dragging the window to the top, bottom, left, or right edge of the main viewing area of the application will dock the window at that location

[Press and hold the CTRL key down to prevent Docking when moving the window]

#### Hot Links

You can click on any I/O function block or Signal on the Controller Worksheet or any I/O function block, Signal, or Variable in the Watch Window and that item will be located on the Function Block Diagram.

As you move the mouse over a HOT LINK, the text changes to Underlined Blue and

the cursor changes to a Hand. 

### **Writes or Forces**

By clicking on the item in the Value column, you may write a value such as for a Variable or force a value for an analog input or digital input. For I/O, a Forced column will indicate that the I/O point is forced.

### **Find Feature**

You can click on any I/O function block or Signal on the Controller Worksheet or any I/O function block, Signal, or Variable in the **Watch Window** and that item will be located on the Function Block Diagram.

As you move the mouse over a HOT LINK, the text changes to Underlined Blue and

the cursor changes to a Hand. 

You can also find within the Watch Summary window itself any tag, descriptor, signal number, variable number, as well as rack number, module number, channel number, or block on the Inputs / Outputs tab. For example, to find a tag in the Watch Summary window, click anywhere in the Tag Name column and start typing the characters of the tag you want to find. The tag matching the characters you type will scroll into view. To find a tag name and prevent the tag hot link from re-positioning the Function Block Diagram, right-click the tag name instead of left-clicking it.

### **Sort Function**

The Sort function in the Watch Summary lets you sort the tag list by:

**Signal #**

**Variable #**

**Tag Name**

**Descriptor**

**Block**

At the top of the Watch Window, click on the **Column title**. The list will be sorted accordingly. Clicking the column title the first time sorts the list in ascending (alphabetical) order. Clicking the column title a second time sorts the list in descending (reverse alphabetical) order, and so forth.

### **Watch Summary - User Defined**

In the User-Defined Watch Window, you can create a list of tags that you want to monitor.

You can add the following to the list:

**Signals**

**Page Connectors**

**Variables**

The Watch Summary window doesn't have to be visible in order to add items to the User-Defined tab of it, nor does the "Show" drop-down menu on the User-Defined tab have to match what you'll be adding.

For example, you can add a signal to the User-Defined tab of the Watch Summary window even if the window is not visible or the User-Defined tab's "Show" drop-down menu is set to All Variables. As long as you are in monitor mode, you can add items at any time.

Also note that you can re-order the items in the list by selecting a single range of rows in the list and dragging the rows to another position in the list. A red line will appear as you drag the rows to show you where they will be dropped when you release the mouse button. Select the rows by positioning the cursor until it is over the gray cell at the beginning of the first (or last) row you want to drag. The cursor will then change to an arrow. While holding down the left mouse button, drag the cursor until it is over the gray cell at the beginning of the last (or first) row you want to drag. Release the mouse button. Then position the cursor over any gray cell in the selected rows and drag and drop the rows to their new position. You can delete items in the list by selecting their rows and pressing the Delete key.

Note that there is no limit to the number of items that you can add to the list, but the list is not saved between sessions of the software.

### How to Create User-defined Watch Summary

From the Monitor menu or Monitor toolbar , select "Watch Summary...".

From the tabs at the bottom of the window, select the **"User-Defined"** tab.

At the top of the window, from the **"Show"** drop-down menu, select what you want shown in the window: All, All Signals, All Page Connectors, All Variables.

On the diagram, select a tag to monitor and Right-Click on the tag.

Select **"Add to Watch Summary"** from the drop-down menu

The tag selected will be listed in the "User-Defined" Watch Window.

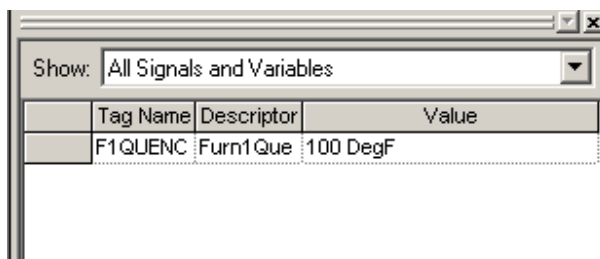

Repeat steps 4 and 5 for each tag you want included in the list.

Use the "Find Feature" to Find a specific tag on the Function Block Diagram.

Use the "Sort Function" to sort the tag list by a specific column.

### Watch Summary - Signals

Select a Signal type to show from the drop-down menu at the top of the dialog box.

**All Signals** - Shows both Analog and Digital Signals in the window.

**Analog Signals** only

**Digital Signals** only

Each signal is identified by Signal Number, Tag Name, Descriptor, and Value and is READ Only.

The screenshot shows the 'Watch Summary' window with a dropdown menu set to 'All Signals'. The window contains a table with the following data:

Signal #	Tag Name	Descriptor	Value
9	SP 6		105
10	SP 7		-5
11	SP 8		105
12	SCHEDFLG		2
13	PROGRAM		0
14	SEGMENT		1
15	STATE		1
16	G HOLD		OFF
17	READY		ON
18	HOLD		OFF
19	RUN		OFF

At the bottom of the window, there are navigation buttons and a tabbed interface with 'Signals' selected.

Use the "Find Feature " to Find a specific tag on the Function Block Diagram.

Use the "Sort Function " to sort the tag list by a specific column.

### Watch Summary - Page Connectors

Select a Page Connector type to show from the drop-down menu at the top of the dialog box.

**All Page Connectors** - Shows both Analog and Digital Page Connectors in the window.

**Analog Page Connectors** only

**Digital Page Connectors** only

Each page connector is identified by Tag name and Value and is READ Only.

The screenshot shows the 'Watch Summary' window with a dropdown menu set to 'All Page Connectors'. The window contains a table with the following data:

Tag Name	Value
0289-021	OFF
0111-019	0.000000
0111-019	0.000000

At the bottom of the window, there are navigation buttons and a tabbed interface with 'Page Connectors' selected.

Use the "Find Feature " to Find a specific page connector on the Function Block Diagram.

Use the "Sort Function " to sort the page connector list by a specific column.

### Watch Summary - Variables

Select a Variable type to show from the drop-down menu at the top of the dialog box.

**All Variables** - Shows both Analog and Digital Variables in the window.

**Analog Variables** only

**Digital Variables** only

Each Variable is identified by Variable Number, Tag Name, Descriptor, and Value.

**You can change a variable** by clicking on a variable value and entering a new value for an analog variable or selecting the appropriate user-configured OFF or ON label from a drop-down menu for a Digital variable.

**Note:** *the new value entered is not written to the controller until you move off of the current cell either by tabbing out of the cell using the Shift+Tab keys or clicking on another cell using the mouse. If the value you want to change also shows engineering units, as in "100.0 LBS", for example, you just need to change the number portion; you don't need to delete the engineering units or type it in again.*

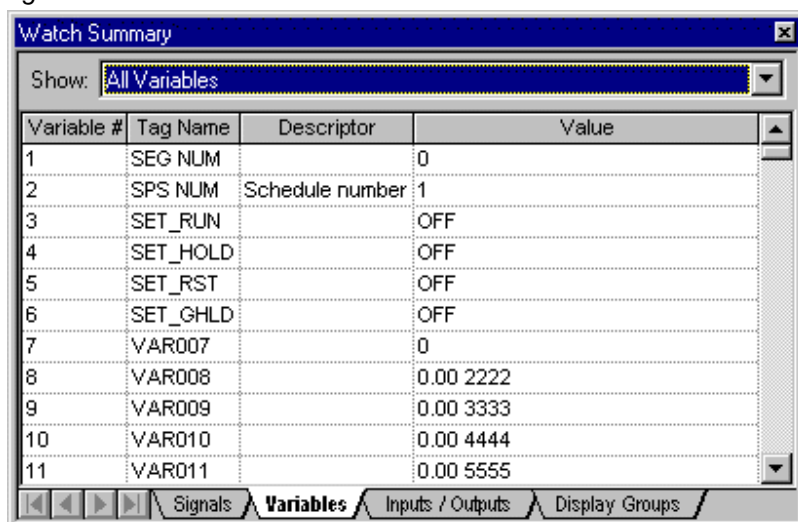

The screenshot shows a window titled "Watch Summary" with a dropdown menu set to "All Variables". Below the menu is a table with the following data:

Variable #	Tag Name	Descriptor	Value
1	SEG NUM		0
2	SPS NUM	Schedule number	1
3	SET_RUN		OFF
4	SET_HOLD		OFF
5	SET_RST		OFF
6	SET_GHLD		OFF
7	VAR007		0
8	VAR008		0.00 2222
9	VAR009		0.00 3333
10	VAR010		0.00 4444
11	VAR011		0.00 5555

At the bottom of the window, there are navigation buttons: "Signals", "Variables" (which is selected), "Inputs / Outputs", and "Display Groups".

Use the "Find Feature " to Find a specific tag on the Function Block Diagram.

Use the "Sort Function " to sort the tag list by a specific column.

### Watch Summary - Inputs/Outputs

Select an Input or Output type to show from the drop-down menu at the top of the dialog box.

**Analog Inputs**

**Analog Outputs**

**Digital Inputs**

**Digital Outputs**

Each Input/Output is identified by Rack, Module, Channel Number, Block Name, Tag Name, Descriptor, Value, and Status.

**NOTE:** *Only "assigned" inputs and outputs are shown in this window. Inputs and outputs whose rack, module, and channel that are all zero are not shown in this window. These unassigned inputs and outputs are shown on the controller worksheet, however.*

**You can Force an Output** by clicking on a value and entering a new value for an analog input or selecting the appropriate user-configured OFF or ON label from a drop-down menu for a digital input or output.

A Checked Box will appear in the Status column indicating that the Output is forced. [Click off the value cell to see the box]

To **Remove a Force**, double-click to deselect the checked box.

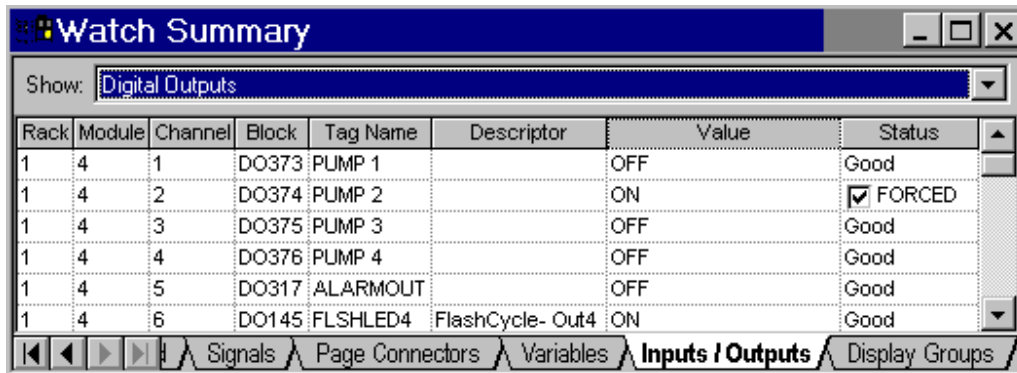

**Notes:**

Analog outputs cannot be forced

Time Proportioning outputs and Three position Step outputs cannot be monitored since the live value is maintained only on the D.O. module itself. The text "n/a" (for "not available") is shown as the value for these outputs.

Use the "Find Feature " to Find a specific tag on the Function Block Diagram.

Use the "Sort Function " to sort the tag list by a specific column.

**Watch Summary - Display Groups**

Watch Summary - Display Groups lets the user monitor the same points configured on the Operator Interface displays.

Select a **Display Group**(Show Menu) then a **Group Number** (Group Menu) from the drop-down menus at the top of the dialog box. The window will monitor the Display Group selected. Note that new values can be written to the variables shown in this window.

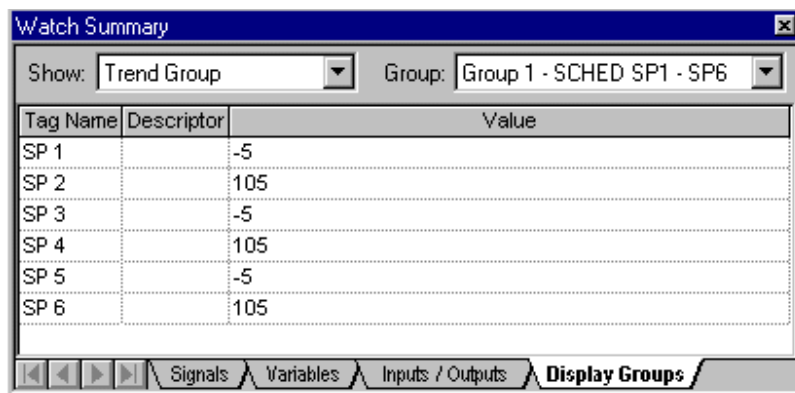

Use the "Find Feature " to Find a specific tag on the Function Block Diagram.

Use the "Sort Function " to sort the tag list by a specific column.



## Diagnostics

### Controller Diagnostics

#### Introduction

The Hybrid Control Utilities provides live monitoring of Controller diagnostics. The instrument executes diagnostic routines during instrument start-up and during on-line operation and displays the controller status and diagnostics.

Select "Controller Diagnostics" from the "Monitor" drop-down menu, from the Monitor toolbar.



(This window can be launched from the "Utilities Worksheet")

The Controller Diagnostics (C30/C50/C70) or Diagnostic Overview (C70R) window will appear.  
See below.

The "Controller Diagnostic Status Indications" explains the parameters and their values.

Click on "X" to exit box.

#### C30/C50/C70:

Parameter	Value
Controller Time	10/27/01 9:51:35 AM
System Diagnostics	Good
CPU Diagnostics	Good
Memory Diagnostics	Good
Real-Time Clock Diagnostics	Good
Rack I/O Diagnostics	Module Error
Communication Port Diagnostics	Good
Hardware okay	OFF
Controller Mode	RUN
Code Revision	99.40
Code Build Revision	D
Loop Capacity	32
Product Type	HC900
Cycle Time (S)	0.51
CPU % used	3.29
Peak Time (S)	0.01
CB Overruns	0
Fast Cycle Time (S)	0.05
Fast CPU % used	0.00
Fast Peak Time (S)	0.00
Fast CB Overruns	0

**C70R:**

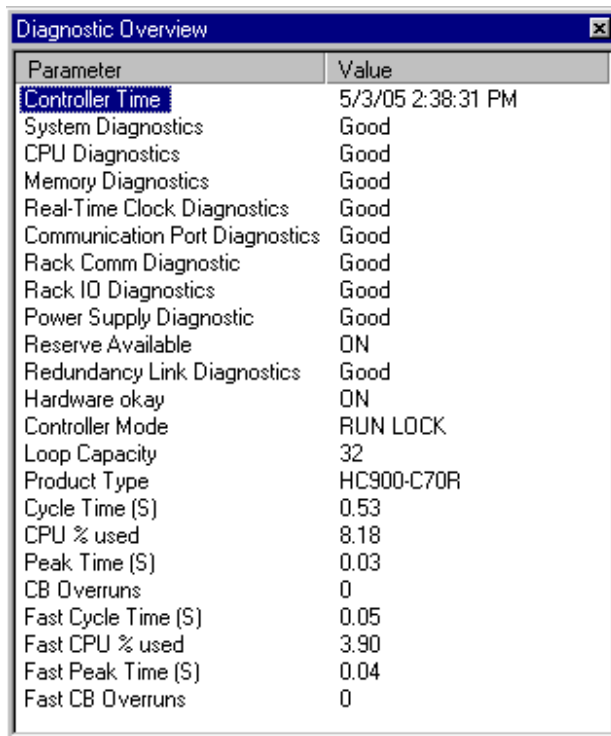

The image shows a screenshot of a software window titled "Diagnostic Overview". The window contains a table with two columns: "Parameter" and "Value". The "Controller Time" parameter is highlighted in blue. The table lists various diagnostic parameters and their current values, including system health, hardware status, and performance metrics.

Parameter	Value
Controller Time	5/3/05 2:38:31 PM
System Diagnostics	Good
CPU Diagnostics	Good
Memory Diagnostics	Good
Real-Time Clock Diagnostics	Good
Communication Port Diagnostics	Good
Rack Comm Diagnostic	Good
Rack IO Diagnostics	Good
Power Supply Diagnostic	Good
Reserve Available	ON
Redundancy Link Diagnostics	Good
Hardware okay	ON
Controller Mode	RUN LOCK
Loop Capacity	32
Product Type	HC900-C70R
Cycle Time (S)	0.53
CPU % used	8.18
Peak Time (S)	0.03
CB Overruns	0
Fast Cycle Time (S)	0.05
Fast CPU % used	3.90
Fast Peak Time (S)	0.04
Fast CB Overruns	0

## Controller Diagnostics Status Indications

For C30/C50/C70, the "Controller Diagnostics" window appears. For C70R, the "Diagnostics Overview" window appears.

### C30/C50/C70 Controller Diagnostics parameters

Parameter	Value	Possible Cause	Controller Action	User Action
System Diagnostics	Good	Controller is in RUN mode.	Executes the run mode. Outputs are updated.	None
	Forced Output	A block has an output that is forced.	None	Remove force on block output.
	Invalid Config.	A configuration that exceeds the loop capacity of the controller was downloaded or an invalid configuration exists.	An empty database is created.	Download a valid configuration.
	Switch Fault	A failure is detected in the switch reading.	All control blocks stop running All I/O scanning ceases. This forces the modules into failsafe.	Replace CPU.
CPU Diagnostics	Good	N/A	N/A	N/A
	Watchdog	Watchdog reset resulting from software failure	Associated rack monitor block's RACK OK pin is turned off. ASYS block's HW OK pin is turned off.	Force a cold start. Upgrade control file software. Replace CPU board. Contact Honeywell Personnel.
	Prefetch Abort	CPU failed when attempting to fetch an instruction from the prefetch register.	Controller performs a restart Associated rack monitor block's RACK OK pin is turned off. ASYS block's HW OK pin is turned off.	Force a cold start. Isolate system from noise and force a cold start. Replace CPU board
	Address Error	The reserved exception occurred for an unknown reason.	Same as above	Same as above
	Undefine Error	Bad Instruction Detected	Same as above	Same as above
	Data Abort	CPU failed when attempting to access data.	Same as above	Same as above
	Software Interrupt Error	Software Interrupt occurred which is not supported by the software.	Same as above	Same as above

Diagnostics  
 Controller Diagnostics Status Indications

Parameter	Value	Possible Cause	Controller Action	User Action
Memory Diagnostics	Good	N/A	N/A	N/A
	5 Day Low Battery Warning	Estimated battery life is less than 5 days.	Associated rack monitor block's RACK OK pin is turned off. ASYS block's HW OK pin is turned off.	Replace battery.
	Low Battery	Battery voltage is low.	Associated rack monitor block's RACK OK pin is turned off. ASYS block's LOW BATTERY pin is turned on. ASYS block's HW OK pin is turned off.	Replace battery.
	Flash Error	Flash failed to burn	Associated rack monitor block's RACK OK pin is turned off. ASYS block's HW OK pin is turned off.	Force a cold start. Replace CPU board.
Real Time Clock Diagnostics	Good	N/A	N/A	N/A
	Not Programmed	RTC not programmed	Time and date is set to 00:00:00, January 1, 1970. Associated rack monitor block's RACK OK pin is turned off. ASYS block's HW OK pin is turned off.	Program RTC.
	Bad Data	Bad date and time	Same as above	Program RTC. Cycle power. Replace CPU. Replace boards in rack. Replace rack
	Programming Failure	RTC failed to program	Same as above	Same as above
	Read Failure	Unable to read RTC	Same as above	Same as above
Rack I/O	Good	N/A	N/A	N/A

Diagnostics  
Controller Diagnostics Status Indications

Parameter	Value	Possible Cause	Controller Action	User Action
Diagnostics	Module Error	One of the module diagnostics in the associated rack is set to WRONG MODULE, MODULE NO COMM (if the communications is failing due to the module not installed), BAD MODULE, or BAD CHANNEL.	Refer to related Module diagnostic.	Access the I/O Module diagnostics screen.
	Hi Temp	One of the module diagnostics in the associated rack is set to HI CJ TEMPERATURE.	Refer to HI CJ TEMPERATURE in Module diagnostics	Access the I/O Module diagnostics screen
	Rack Backplane Fail	The Main CPU/Scanner is unable to successfully communicate to any modules that are in its SPI backplane.	All associated module diagnostics are set to MODULE NO COMM.  Refer to MODULE NO COMM diagnostic for further details.	<ul style="list-style-type: none"> <li>• Remove modules and check for bent pins on connectors.</li> <li>• Reinsert modules one at a time and note which module the diagnostic reoccurs, and replace that module.</li> <li>• Cycle power to the rack.</li> <li>• Replace the power supply.</li> <li>• Replace the rack.</li> <li>• Replace the CPU board.</li> </ul>
	Rack Comm Fail	The Main CPU is unable to successfully communicate to an expansion rack that is in its configuration.  <b>Please note that there are NO expansion racks permitted on the HC900-C30 controller.</b>	Same as above	<p>Verify that the expansion rack should be in the configuration</p> <p>Verify that the jumpers on the scanner are setup for the correct rack address.</p> <p>Check that expansion rack is on.</p> <p>Check the expansion rack's status LED for diagnostic information.</p> <p>Check that cable is connected to expansion rack.</p> <p>If a hub is used, check that all cables are properly connected to the hub, proper crossover cables are used, and that hub is powered.</p> <p>Cycle power to the rack.</p> <p>Cycle power to the hub.</p> <p>Replace the expansion rack's power supply.</p> <p>Replace the expansion rack.</p> <p>Replace the expansion rack's scanner board.</p>

Diagnostics  
Controller Diagnostics Status Indications

Parameter	Value	Possible Cause	Controller Action	User Action
	Rack SW Incompatibility	The Main CPU determined that its software is not compatible with the scanner module.	All associated module diagnostics are set to MODULE NO COMM.  Refer to MODULE NO COMM diagnostic for further details.	Upgrade the scanner software either by replacing the module or doing a code-download.  Update Main CPU software either by replacing the module or doing a code download.
Comm Port Diagnostics	Good	N/A	N/A	N/A
	Warning	One of the comm port's is reporting an application error	<i>Refer to related Comm port diagnostic</i>	Access the Comm port diagnostics screen
	Failed	One of the Comm port's is reporting a physical or data link failure	<i>Refer to related Comm port diagnostic</i>	Same as above

**C70R Diagnostic Overview parameters**

Parameter	Value	Possible Cause	Controller Action	User Action
System Diagnostics	Good	Controller is in RUN mode.	Executes the run mode. Outputs are updated.	None
CPU Diagnostic	Good	System is functional	None	None
	Rack 'n'	Rack 'n' is reporting a diagnostic	Diagnostic may cause a failover  Diagnostic may prevent a failover	Refer to the Rack Diagnostics for more details
	Multiple Racks	More than one Rack is reporting a diagnostic	Diagnostic may cause a failover  Diagnostic may prevent a failover	Refer to the Rack Diagnostics for more details
	Lead CPU	The Lead CPU is reporting a diagnostic	None	Refer to the Lead CPU Diagnostics for more details
	Reserve CPU	The Reserve CPU is reporting a diagnostic	None	Refer to the Reserve CPU Diagnostic for more details
	Serial Port S1 or S2	There is a diagnostic on the Lead CPU Serial Port (S1 or S2)	None	Refer to the Serial Port S1 or Serial Port S2 Diagnostic Screen for more details
	Network E1 or E2	There is a diagnostic on the Lead CPU Network Port E1 or E2	None	Refer to the Network Port Diagnostic Screen for more details

Diagnostics  
Controller Diagnostics Status Indications

Parameter	Value	Possible Cause	Controller Action	User Action
	Scanner Link	Lead CPU is reporting a diagnostic on the Scanner Link	None	Refer to the Lead CPU Diagnostic and the Scanner Link Diagnostic screens for more details
	Redundancy Link	Lead CPU is reporting a diagnostic on the Redundancy Link. There is a problem with the communications between the Lead and Reserve CPUs.	None	Refer to the Lead and Reserve CPU Diagnostic screens for more details.  Check the Redundancy Link Diagnostic screen for more details
Memory Diagnostic	See CPU Diagnostic for possible values			
Real-Time Clock Diagnostic	See CPU Diagnostic for possible values			
Communication Port Diagnostics	See CPU Diagnostic for possible values			
Rack IO Diagnostics	See CPU Diagnostic for possible values			
Rack Comm Diagnostic	See CPU Diagnostic for possible values			
Power Supply Diagnostic	See CPU Diagnostic for possible values			
Reserve Available	On	There is a Reserve CPU Available for failover		
	Off	No Reserve CPU is available Reserve CPU may be powered off Reserve CPU is powered on but synchronizing with the Lead CPU There may be other physical problems with the Reserve CPU	System will not be able to perform a failover	Check that Reserve CPU is powered ON If powered ON, check the Reserve status LED on the Reserve CPU and the RSM Module  Check Reserve CPU Diagnostics for additional details
Redundancy Link	Good			

Diagnostics  
 Controller Diagnostics Status Indications

Parameter	Value	Possible Cause	Controller Action	User Action
Diagnostics				
	Data Link Failure	No Reserve CPU is available Reserve CPU may be powered off Reserve CPU is powered on but synchronizing with the Lead CPU There may be other physical problems with the Reserve CPU	System will not be able to perform a failover	Check that Reserve CPU is powered ON If powered ON, check the Reserve status LED on the Reserve CPU and the RSM Module Check Reserve CPU Diagnostics for additional details
	Hardware Failure	There may be physical problems with the Lead CPU	System will not be able to perform a failover	Replace the Lead CPU

## Rack Diagnostics

### Introduction

The Hybrid Control Utilities provides live monitoring Rack diagnostics. The instrument executes diagnostic routines during instrument start-up and during on-line operation.

Select the "Rack Diagnostics" from the "Monitor" drop-down menu or from the Monitor Toolbar.



(This window can be launched from the "Utilities Worksheet"

The "Rack Diagnostic Summary" dialog box will appear.

Select a Rack from the "Monitoring Rack" drop-down menu on the dialog box. The information for the selected rack will appear on the dialog box.

The summary window will provide Controller status and diagnostic information **for the selected Rack:**

**Rack in Configuration** - ON or Off

**High CJ Temp status** - On or Off

**Revision Level of the Rack** - Read Only

**Number of Slots** - Read Only

**Rack Diagnostics** - The status of the selected rack. Refer to "Controller Diagnostics Status Indications" for diagnostic messages. Not all diagnostics appear for expansion racks.

**Power Supply Diagnostics** – C70R only. Status of the rack's power supply/supplies. See Rack Diagnostics: Power Supply .

**Expansion I/O Comm Diagnostics (except C30 CPU)** - The status of the Expansion I/O Comm Diagnostics. Refer to "Expansion I/O Comm Diagnostic Status Indicators". Read the diagnostics for a particular rack.

**I/O Module Diagnostics** - Status of the Modules shown in the list:

Physical Type

Configured as (type)

Error Status. – Refer to "I/O Rack Diagnostic Status indicators" for status indications, possible cause, and actions to correct the problem.

Model Number & Rev Level (scroll horizontally to view)

For status of individual I/O channels, see Function Block Monitor Window .

Click on upper right X to exit box.

**C30/C50/C70:**

**Rack Diagnostics**

Monitoring Rack: Rack 2

Rack in Config: OFF

Hi CJ Temp: OFF

Rev Level: 0.00-

# Slots: 0

**Rack Diagnostics**

System: n/a for this rack  
Real-Time Clock: n/a for this rack  
Comm Ports: n/a for this rack  
CPU: Good  
Memory: Good  
I/O: Good

**Expansion I/O Comm Diagnostics**

Rack Comm: Good  
Number of Messages: 0  
Data Link Errors: 0

Clear Statistics

**I/O Module Diagnostics**

Module	Physical Type	Configured As	Error Status
1	None	None	
2	None	None	
3	None	None	
4	None	None	
5	None	None	
6	None	None	
7	None	None	
8	None	None	
9	None	None	
10	None	None	
11	None	None	
12	None	None	

**C70R:**

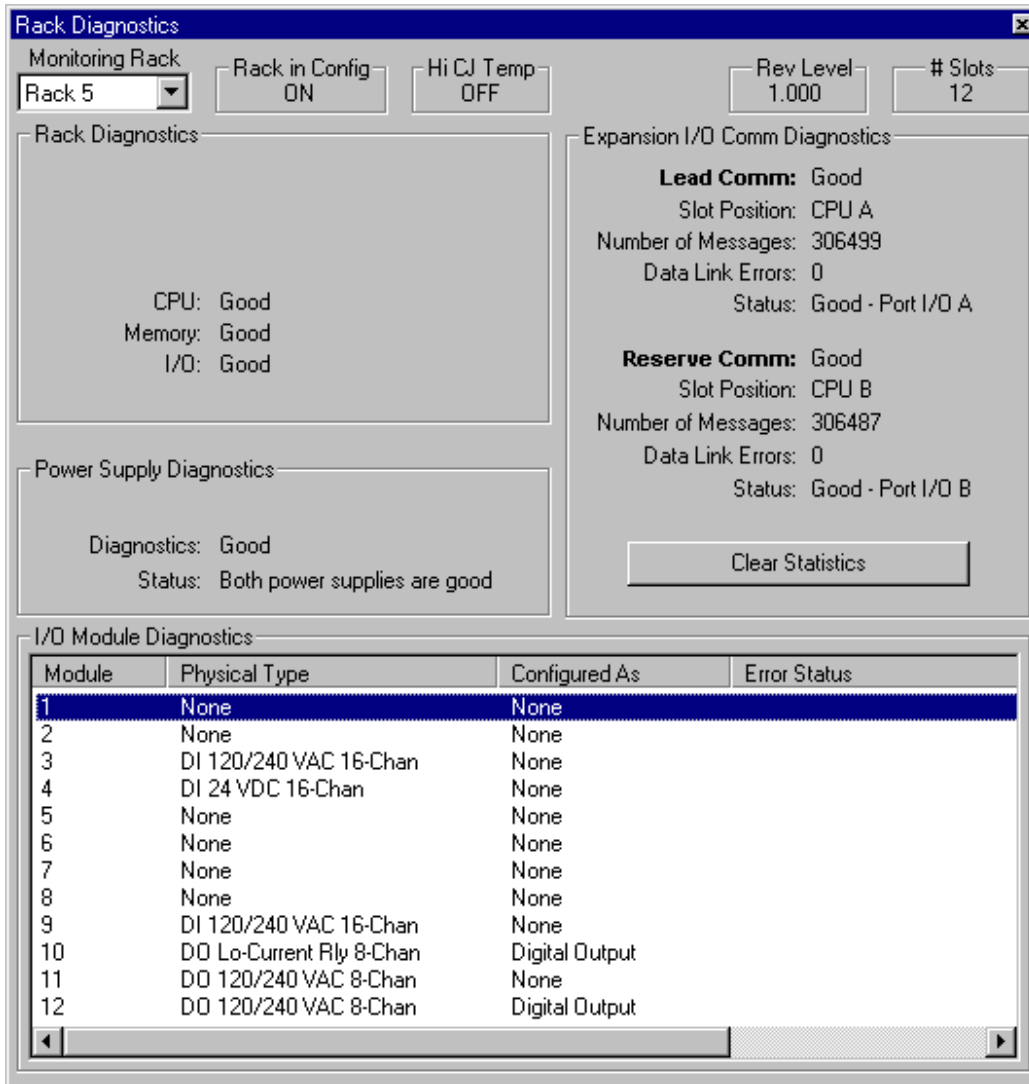

## Rack Diagnostics: Power Supply

The Power Supply diagnostics provide status of the parameters shown in the list.

Parameter/Message	Value	Possible Cause	Controller Action	User Action
Power Supply Status	Unknown	No rack communication.	If under power I/O will switch to failsafe values Loss of Comms	Determine & correct cause of communication failure
			If not powered (un-powered outputs) Loss of AC mains	Restore rack operation Restore AC main power, reset breaker

Diagnostics  
 Rack Diagnostics: Power Supply

Parameter/ Message	Value	Possible Cause	Controller Action	User Action
			Bad power supply Failed scanner2	Replace Power supply Replace scanner2
	Redundant P/S is not present	Single power supply configuration	Status reported Rack continues to function properly	No action required if single power supply rack.
		Redundant Power Backplane not detected	Status reported Rack continues to function properly	If dual power supplies installed Replace Redundant Power Backplane Replace rack backplane Replace Scanner2.
	Power Supply PS-1 Failed (PS-1 LED is OFF)	No AC Mains on PS-1	Diagnostic reported. Rack continues to function properly. Status posted.	Restore AC main power, reset breaker.
		Failed Power Supply		Replace Power Supply
		Failed Redundant Power Backplane detection circuit		Requires unit shutdown - Replace Redundant Power Backplane
	(PS-1 LED is ON)	Failed rack backplane status signal		Requires unit shutdown - Replace rack backplane.
		Failed Scanner2 status input		Requires unit shutdown - Replace Scanner2.
	Power Supply PS-2 Failed (PS-2 LED is OFF)	No AC Main on PS-2	Diagnostic reported. Rack continues to function properly. Status posted.	Restore AC main power, reset breaker.
		Failed Power Supply		Replace Power Supply
		Failed Redundant Power Backplane detection circuit		Requires unit shutdown - Replace Redundant Power Backplane
	(PS-2 LED is ON)	Failed rack backplane status signal		Requires unit shutdown - Replace rack backplane.
		Failed Scanner2 status input		Requires unit shutdown - Replace

Parameter/ Message	Value	Possible Cause	Controller Action	User Action
				Scanner2
	Both Power Supplies are Good	NA	None	None
Power Supply Diagnostic	See Power Supply Status for possible values			

## I/O Module Diagnostics Status Indications

The "I/O Module Diagnostic Summary" dialog box will provide status of the parameters shown in the list.

The following table lists the possible Error Statuses.

Error Status	Possible Cause	Controller Action	User Action
Good	N/A	N/A	N/A
Hi CJ Temperature	<p>Possible causes of this diagnostic are:</p> <p>One of the two C.Js on the module is indicating a temperature reading greater than 70 degrees C.</p> <p>Both cold-junction sensors are failing to convert.</p> <p>The C.Js are converting properly, but their differential is greater than 10 degrees C.</p>	<p>Associated AI blocks that are configured as T/Cs set their fail pin on, their warn pin off, and their output pin to the failsafe value.</p> <p>Associated AI blocks that are configured as T/Cs set their IO status to "CJ High Temperature" for reason 1 or "CJ Failure" for possible causes 2 and 3.</p> <p>Associated rack monitor block's module fail pin is turned on.</p> <p>Associated rack monitor block's RACK OK pin is turned off.</p> <p>Associated rack monitor block's HITEMP pin is turned on.</p> <p>ASYS block's HITEMP pin is turned on.</p> <p>ASYS block's HW OK pin is turned off.</p>	<p>Improve ventilation to rack</p> <p>Replace AI module</p>
Wrong Module	The module does not agree with the module required for the control scenario	<ol style="list-style-type: none"> <li>1. Associated blocks set their fail pin on, their warn pin off, and their output pin to the failsafe value.</li> <li>2. Associated blocks set their IO status to "Channel No Comm".</li> <li>3. Associated rack monitor block's module fail pin is turned on.</li> <li>4. Associated rack monitor block's RACK OK pin is turned off.</li> <li>5. ASYS block's HW OK pin is turned off.</li> </ol>	<ol style="list-style-type: none"> <li>1. Verify configuration</li> <li>2. Replace module with the correct one.</li> </ol>

Error Status	Possible Cause	Controller Action	User Action
#Module No Comm	<p>Main CPU is unable to communicate to the module for one of the following reasons:</p> <ul style="list-style-type: none"> <li>Module is not installed</li> <li>The module cannot communicate with the controller CPU or the expansion rack CPU because of a backplane problem. Module is on an expansion rack and the expansion rack communications are failing</li> </ul>	See Wrong Module.	<p>Action is based on the IODIAG indication. If IODIAG is not MODULE ERROR, then follow the prescribed action defined for that diagnostic.</p> <p>For MODULE ERROR, do the following:</p> <p>Verify configuration Install module. Check the communication cables that connect the expansion rack(s) to the Main Rack. Replace the controller or expansion rack backplane.</p>
Bad Module	Module is bad. Module LED flashes to indicate the problem.	N/A	See HC900 Controller Manual 51-52-25-107, I/O Module Indicators. A table describes the LED flashes and what they mean.
Bad Channel	One or more channels in the module is bad.	The I/O rack's Scanner status LED and the Controller rack's status LED (not the module or channel LED) flash 6 times.	<p>1) To determine which channel(s) are bad, monitor the function blocks corresponding to the channels in this module. See <a href="#">Function Block Monitor Window</a> Check each I/O function block's "<a href="#">Channel/Sensor Status</a>".</p> <p>2) To determine the cause, see HC900 Controller Manual 51-52-25-107, I/O Module Indicators, Bad I/O Channel Diagnostics. A table describes the channel statuses and what they mean.</p>

## I/O Channel/Sensor Status

When [monitoring blocks](#) of the type in the table below, the Channel/Sensor Status is displayed. Statuses vary in severity; the more serious will trigger an error message/indicator elsewhere, such as a I/O Module Diagnostic Error or a flashing LED on the I/O rack.

Here is an alphabetical list of possible statuses for each I/O channel type.

Channel/Sensor Status	Channel type											Possible Cause	User Action
	AI	AO	DI	DO	TPO	TPSC	PI	PO	FI	QUAD			
Good	√	√	√	√	√	√	√	√	√	√	√	Normal operation	
Bad Channel		√							√			There are two possible causes for this error:  1. If the channel is an Analog Output: There is no physical output device connected to this channel, or the output device is showing an "open" connection.  2. If the channel is a Pulse Output: The channel is failing to output the correct value.  A BAD CHANNEL I/O module diagnostic is posted.	Check terminal connections.  Replace module.
Burnout Failure		√										The sensor – T/C, RTD, or mV source -- is failing burnout checks. A BAD CHANNEL I/O module diagnostic is posted.	Check terminal block connections  Replace source element  Replace module.
CJ Failure		√										Two conditions can create this failure.  1. Both cold-junction sensors are failing to convert.  2. The CJs are converting properly, but their differential is greater than 10 degrees C.  In either case a HI CJ TEMP I/O module diagnostic is posted.	Improve ventilation to rack.  Replace AI module.
CJ High Temperature		√										One of the CJs is indicating a temperature reading above 70 degrees C. A HI CJ TEMP I/O module diagnostic is posted.	Improve ventilation to rack.  Replace AI module.
CJ Warning		√										One of the cold-junction sensors is failing to convert. The temperature compensation for the thermocouple readings could have a slight error because only the good CJ is being used in the temperature calculation.	
Clamp High		√										The AO block's input is greater than the block's configured high range value.	

Diagnostics  
I/O Channel/Sensor Status

Channel/Sensor Status	Channel type										Possible Cause	User Action	
	AI	AO	DI	DO	TPO	TPSC	PI	PO	FI	QUAD			
Clamp Low		√										The AO block's input is less than the block's configured low range value.	
Disabled	√											AI channel is programmatically disabled	
Failed to convert	√											When attempting to take a reading, the analog-to-digital (ADC) fails. This can occur if the incoming signal is either too large or too small. It also could result if the ADC circuit is failing. If the problem is the ADC circuit, most likely other channels will have the same failure. A BAD CHANNEL I/O module diagnostic is posted.	Check the signal level being applied to the terminals. Replace module.
Forced	√		√	√								The point has been manually forced to its present value, probably via a PC host.	
No Channel Available	√		√	√				√	√	√	√	There is no hardware on the I/O module to support this channel. For example, the customer configured Channel #15 for a given module, but there is an 8-channel module installed in the rack. A BAD CHANNEL I/O module diagnostic is posted.	
No Comm	√	√	√	√	√	√						The Main CPU is unable to communicate to the channel. Possible reasons are module missing, wrong module installed, SPI backplane is failing, expansion rack is missing.	
Over current				√				√	√	√	√	A Digital Output module detected an excessive amount of current on its output terminals. Note that this message will only appear for the 32-channel DO module. A BAD CHANNEL module diagnostic is posted.	
Over range	√											The signal at the terminals is more than 10% over the range of the sensor.	Check the signal level being applied to the terminals. Replace module.
Sensor & Range type not available	√											The AI module installed in the rack does not support the range or sensor type	

Channel/Sensor Status	Channel type										Possible Cause	User Action
	AI	AO	DI	DO	TPO	TPSC	PI	PO	FI	QUAD		
T/C Failing	√										configured for this channel. For example, this channel's AI function block is configured as a thermocouple, but there is a high-level AI module installed in the rack.	
T/C Warning	√										When burnout check occurs on the T/C, the measured resistance indicates that the T/C's resistance is to a point where the burnout failure will result.	
Under range	√										The signal at the terminals is less than 10% below the range of the sensor.	Check the signal level being applied to the terminals.  Replace module.
Wrong Firmware Rev	√										The firmware in the AI module is not compatible with the firmware in the controller or scanner CPU, or  AI module does not support slidewire as an input type.	

## Controller Ports Diagnostics







### Accessing Port Diagnostics

#### Overview

The Hybrid Control Utilities provides live monitoring of Controller Ports diagnostics. The instrument executes diagnostic routines during instrument start-up and during on-line operation.

Select "Controller Ports Diagnostics" from the "Monitor" drop-down menu or from the Monitor toolbar.

There is a sub-menu from which you can choose the type of port you want to monitor:

Toolbar	Menu
	Serial Port S1 (RS232 Default) Configuration Port Diagnostics
	Serial Port S2 (RS485 default) OI Port Diagnostics
	Network Port Diagnostics
	Expansion I/O Comm Diagnostics (except C30 CPU)
	Host Connections Diagnostics
	Peer-to-Peer Connections Diagnostics

The specific monitoring dialog box for that selection will open.

#### Serial Port S1 (RS232 Default) Configuration Port Diagnostics

The Hybrid Control Utilities provides live monitoring of the Serial Port S1 Configuration Port (default RS232). The instrument executes diagnostic routines during instrument start-up and during on-line operation.

Select "Controller Ports Diagnostics" from the "Monitor" drop-down menu then select "Serial Port S1" from the list provided or from the Monitor toolbar.



The "Serial Port S1 Diagnostic Summary" dialog box will appear. It shows Port Status, Diagnostics, Statistics and parameters for the Serial Port S1 Configuration Port.

(This window can be launched from the "Utilities Worksheet")

The summary will provide status of the parameters shown in the list.

Click on "X" to exit box.

Refer to the Serial Port S1 (RS232 default) Configuration Port Diagnostics Status Indicators for status indications, possible cause, and actions to correct the problem.

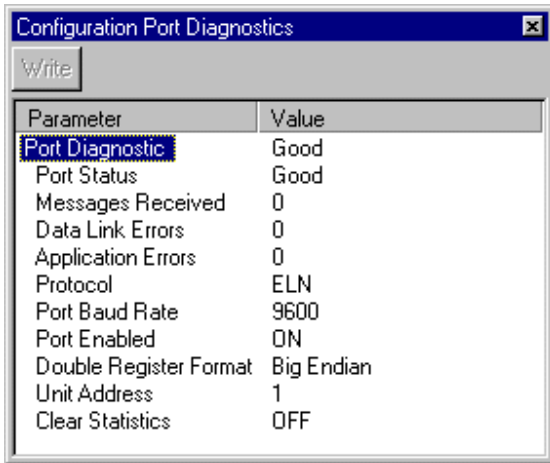

### Serial Port S1 (RS232 default) Configuration Port Diagnostics Status Indicators

The "Serial Port S1 Diagnostic Summary" dialog box will provide status of the parameters shown in the list.

Value	Possible Cause	Controller Action	User Action
Good	N/A	N/A	N/A

Diagnostics  
Controller Ports Diagnostics

Value	Possible Cause	Controller Action	User Action
Data Link Failure	A large number of messages are resulting in data link errors.	<p>Rack 1 monitor block's COMPORT DIAG is set to FAILED.</p> <p>Rack 1 monitor block's RACK OK pin is turned off.</p> <p>ASYS block's HW OK pin is turned off.</p> <p>If configured as a Modbus master: ASYS and FSYS blocks' Modbus Master Fail pins are turned on.</p> <p>Slave and read blocks associated with the slaves experiencing the failure have their read pins frozen to the last value read.</p> <p>Slave blocks associated with the slaves experiencing the failure have their BAD COMM and NO SCAN pins turned on.</p> <p>IN SCAN STATUS is set to NO for all slaves experiencing the failure.</p> <p>COMM STATUS is set to BAD for all slaves experiencing the failure.</p> <p>The slaves with the data link errors have a non-zero data link error count.</p> <p>The slaves experiencing the failure are moved to the background scan rate.</p>	<p>Check baud rate</p> <p>Check connectors</p> <p>Check cable polarity</p> <p>Isolate cabling from electrical interference</p> <p>If RS232 to RS485 converter is used, check its power, switch/jumper settings, and polarity.</p> <p>If configured as a Modbus master, use the slave status screens to determine which slaves are experiencing the problem. For those slaves check:</p> <ul style="list-style-type: none"> <li>• power</li> <li>• connections</li> <li>• address</li> <li>• baud rate</li> <li>• parity</li> <li>• number of stop bits</li> <li>• for electrical interference</li> <li>• grounding</li> <li>• termination resistor (if at end of link)</li> </ul> <p>The diagnostic is cleared by clearing the port's statistics.</p>

Value	Possible Cause	Controller Action	User Action
HW Failure	The DUART is failing to operate properly.	Rack 1 monitor block's COMPORT DIAG is set to FAILED. Rack 1 monitor block's RACK OK pin is turned off. ASYS and FSYS blocks' HW OK pins are turned off. If configured as a Modbus master: ASYS and FSYS blocks' Modbus Master Fail pins are turned on.  All Modbus slave and Modbus read blocks have their read pins frozen to the last value read.  All slave blocks have their BAD COMM and NO SCAN pins turned on.  IN SCAN STATUS is set to NO for all slaves.  COMM STATUS is set to BAD for all slaves in the function block diagram.  Statistical data for all slaves is frozen.  All slaves in the function block diagram are scanned at the background scan rate.	Replace CPU module

### Serial Port S2 (RS485 default) OI Port Diagnostics

The Hybrid Control Utilities provides live monitoring of the S2 (RS485 default) OI Port. The instrument executes diagnostic routines during instrument start-up and during on-line operation.

Select "Controller Ports Diagnostics" from the "Monitor" drop-down menu then select "Serial Port S2" from the list provided or from the Monitor toolbar.



The "Serial Port S2 Diagnostic Summary" dialog box will appear.

It shows Port Status, Diagnostics, Statistics and parameters for the Serial S2 Port (default RS485 for Operator Interface).

(This window can be launched from the "Utilities Worksheet"

The summary will provide status of the parameters shown in the list.

Click on "X" to exit box.

Refer to the Serial Port S2 (RS485 default) OI Port Status Indicators for status indications, possible cause, and actions to correct the problem.

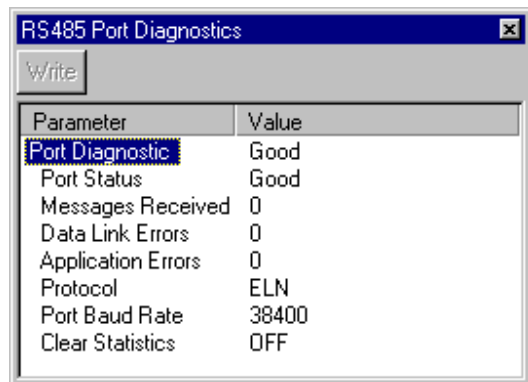

### Serial Port S2 (RS485 default) OI Port Status Indicators

The "Serial Port S2 Diagnostic Summary" dialog box will provide status of the parameters shown in the list.

Value	Possible Cause	Controller Action	User Action
Good	N/A	N/A	N/A
Application Error	At least 1 response to a host resulted in an exception code or NAK.	Rack 1 monitor block's COMPORT DIAG is set to WARNING. Rack 1 monitor block's RACK OK pin is turned off. ASYS block's HW OK pin is turned off.	At host, determine which message is causing the exception code and fix.
Data Link Failure	A large number of messages are resulting in data link errors.	Rack 1 monitor block's COMPORT DIAG is set to FAILED. Rack 1 monitor block's RACK OK pin is turned off. ASYS block's HW OK pin is turned off. If configured as a Modbus Master port, associated slave blocks have their read pins frozen to the last value read.	Check baud rate Check connectors Check cable polarity Isolate cabling from electrical interference If RS232 to RS485 converter used, check its power, switch/jumper settings, and polarity.
HW Failure	The DUART is failing to operate properly.	Same as above	Replace CPU module

### Network Port Diagnostics

The Hybrid Control Utilities provides live monitoring of the Ethernet Network Port. The instrument executes diagnostic routines during instrument start-up and during on-line operation.

Select "Controller Ports Diagnostics" from the "Monitor" drop-down menu then select "Network Port" from the list provided or from the Monitor toolbar.



(This window can be launched from the "Utilities Worksheet"

The "Network Port Diagnostic Summary" dialog box will appear. It shows Port Status, Diagnostics, Statistics and parameters for the Ethernet Network Port.

The summary will provide status of the parameters shown in the list.

Click on "X" to exit box.

Refer to "Network Port Diagnostics Status Indicators" for status indications, possible cause, and actions to correct the problem.

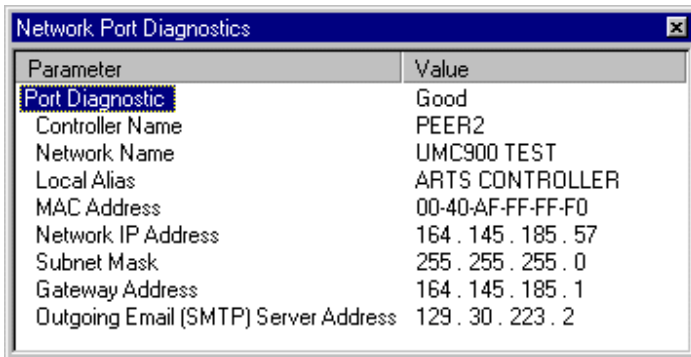

### Network Port Diagnostic Status Indicators

The "Network Port Diagnostic Summary" dialog box will provide status of the parameters shown in the list.

Value	Possible Cause	Controller Action	User Action
Good	N/A	N/A	N/A
Network Setup Error	Controller/network names determined on network are illegal	Rack 1 monitor block's COMPORT DIAG is set to FAILED. Rack 1 monitor block's RACK OK pin is turned off. ASYS block's HW OK pin is turned off.	Correct the setup problem.
No IP Address	DHCP and IP address are not configured	Same as above	If a DHCP server is present, download a configuration that uses DHCP. Enter an IP address
Hardware Failure	Ethernet port tests failed during power-up.	Same as above	Replace CPU Module

### Expansion I/O Comm Diagnostics

The Hybrid Control Utilities provides live monitoring of the Expansion I/O Comm subsystem. The instrument executes diagnostic routines during instrument start-up and during on-line operation.

Select "Controller Ports Diagnostics" from the "Monitor" drop-down menu then select "Expansion I/O Comm" from the list provided or from the Monitor toolbar.

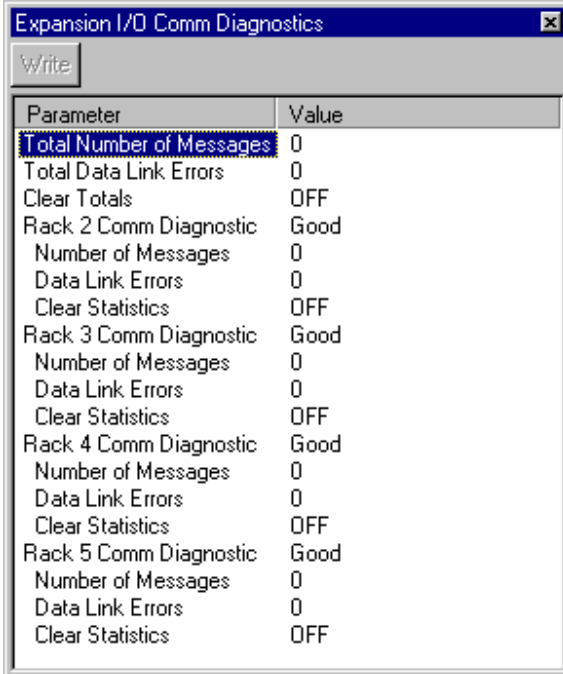

Parameter	Value
Total Number of Messages	0
Total Data Link Errors	0
Clear Totals	OFF
Rack 2 Comm Diagnostic	Good
Number of Messages	0
Data Link Errors	0
Clear Statistics	OFF
Rack 3 Comm Diagnostic	Good
Number of Messages	0
Data Link Errors	0
Clear Statistics	OFF
Rack 4 Comm Diagnostic	Good
Number of Messages	0
Data Link Errors	0
Clear Statistics	OFF
Rack 5 Comm Diagnostic	Good
Number of Messages	0
Data Link Errors	0
Clear Statistics	OFF

(This window can be launched from the "Utilities Worksheet")

The "Expansion I/O Comm Diagnostic Summary" dialog box will appear. It shows Port Status, Diagnostics, Statistics and parameters for the I/O Expansion I/O Comm subsystem.

The summary will provide status of the parameters shown in the list.

Click on "X" to exit box.

Refer to "Expansion I/O Comm Diagnostics Status Indicators" for status indications, possible cause, and actions to correct the problem.

### Expansion I/O Comm Diagnostics Status Indicators

The "Expansion I/O Comm Diagnostic Summary" dialog box will provide status of the parameters shown in the list. **(C50, C70 and C70R CPU only)**

Value	Possible Cause	Controller Action	User Action
Good	N/A	N/A	N/A
Data Link Failure	The communications to a particular rack is resulting in a lot of DLL errors.	Related rack monitor block's RACK OK pin is turned off. Depending on the nature of the DLL errors, the associated rack monitor block's module diagnostics, and pins could be affected.	Use the OI to determine which rack is experiencing the DLL errors. Verify that the expansion rack should be in the configuration Verify that the jumpers on the scanner are setup for the correct rack address.  If a hub is used, check that all cables are properly connected to the hub, proper crossover cables are used, and that hub is powered.  Cycle power to the rack. Cycle power to the hub. Replace the HC900-C50 expansion rack's power supply. Replace the HC900-C50 expansion rack. Replace the HC900-C50 expansion rack's scanner board. Replace the main CPU.
Hardware Failure	The power-up test of the expansion rack Ethernet controller failed.	All rack monitor block XIO PORT DIAG are set to HWFAIL. All rack monitor block RACK OK pin are turned off.  All modules in the configuration have their diagnostic set to MOD_NOCOMM, their rack monitor module fail pin is turned on., and the rack monitor block's RACK OK pin is turned off.  ASYS block's HW OK pin is turned off.  The statuses for the AO and AI channels that are affected are set to BAD_CHANNEL.	Replace main-CPU module
Port A/B Cable Mismatch	C70R only. The I/O cables from CPUA and CPUB are connected to the wrong ports on the I/O scanner CPU	Controller continues to run but is not able to access the I/O on the associated rack	Swap the cables so that I/O A is connected to I/O on CPUA and I/O B is connected to I/O on CPUB
Protocol Mismatch	C70R only. The firmware version in the controller CPU is not compatible with the firmware version in the I/O scanner	Controller continues to run but is not able to access the I/O on the associated rack	Upgrade the firmware in the CPU and/or scanner to be compatible versions

### Host Connections Diagnostics

The Hybrid Control Utilities provides live monitoring of the Host Connections. The instrument executes diagnostic routines during instrument start-up and during on-line operation.

Select "Controller Ports Diagnostics" from the "Monitor" drop-down menu then select "Host Connections" from the list provided or from the Monitor toolbar.



(This window can be launched from the "Utilities Worksheet")

The "Host Connections Diagnostic Summary" dialog box will appear.

The summary will provide status of the parameters shown in the list.

Click on "X" to exit box.

Refer to "Host Connections Diagnostics Status Indicators" for status indications, possible cause, and actions to correct the problem.

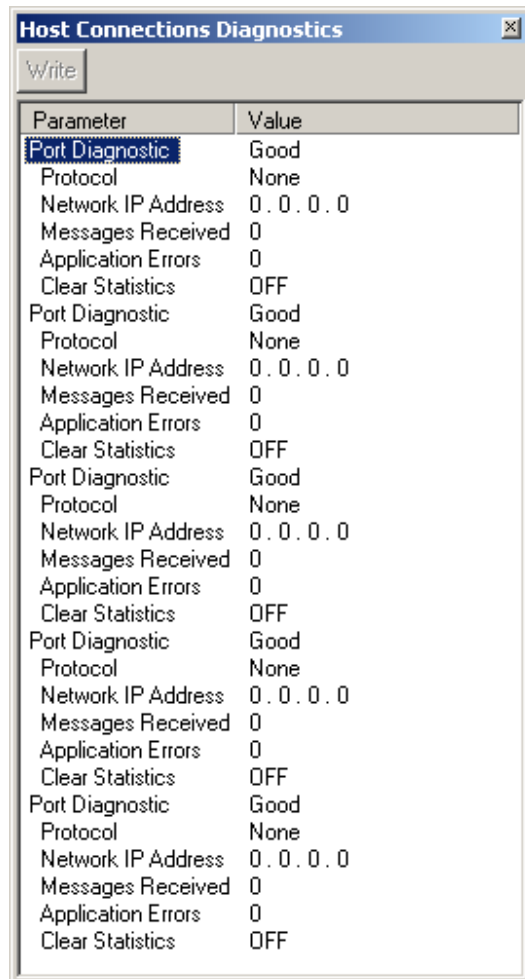

Parameter	Value
Port Diagnostic	Good
Protocol	None
Network IP Address	0 . 0 . 0 . 0
Messages Received	0
Application Errors	0
Clear Statistics	OFF
Port Diagnostic	Good
Protocol	None
Network IP Address	0 . 0 . 0 . 0
Messages Received	0
Application Errors	0
Clear Statistics	OFF
Port Diagnostic	Good
Protocol	None
Network IP Address	0 . 0 . 0 . 0
Messages Received	0
Application Errors	0
Clear Statistics	OFF
Port Diagnostic	Good
Protocol	None
Network IP Address	0 . 0 . 0 . 0
Messages Received	0
Application Errors	0
Clear Statistics	OFF

### Host Connections Diagnostics Status Indicators

The "Network Host Connections Diagnostic Summary" dialog box will provide status of the parameters shown in the list.

Parameter	Value	Possible Cause	Controller Action	User Action
Network Host Connections Diagnostics	Good	N/A	N/A	N/A
	Application Error	At least 1 response to a host resulted in an exception code	Rack 1 monitor block's COMPORT DIAG is set to WARNING. Rack 1 monitor block's RACK OK pin is turned off. ASYS block's HW OK pin is turned off.	At host, determine which message is causing the exception code and fix.

### Peer-to-Peer Connections Diagnostics

The Hybrid Control Utilities provides live monitoring of the Peer-to-Peer Connections. The instrument executes diagnostic routines during instrument start-up and during on-line operation.

Select "Controller Ports Diagnostics" from the "Monitor" drop-down menu then select "Peer-to-Peer Connections" from the list provided.

(This window can be launched from the "[Utilities Worksheet](#)") Select "Controller Diagnostics" icon then select "Controller Ports Diagnostics" then "Peer-to-Peer" Connections.

The "Peer-to-Peer Connections" dialog box will appear.

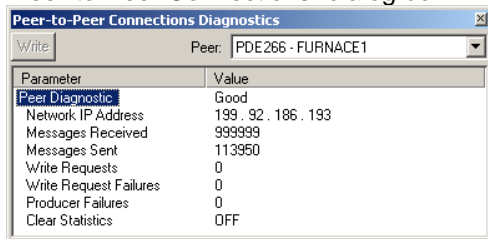

The summary will provide status of the parameters shown in the list.

Click on "X" to exit box.

Refer to "[Peer -to-Peer Connections Diagnostics Status Indicators](#)" for status indications, possible cause, and actions to correct the problem.

### Peer-to-Peer Connections Diagnostics Status Indicators

The “Peer-to-Peer connections” dialog box will provide status of the parameters shown in the list.

The “[Peer-to-Peer connections](#)” dialog box contains a parameter “Peer Status”. Following are the possible statuses.

Value	Possible Cause	Controller Action	User Action
Good	N/A	N/A	N/A
Application Error	The peer connection could not be established due to an internal program problem.	N/A	<ol style="list-style-type: none"> <li>1. Reset the controller to restart the UDP/IP protocol stack and reset buffer allocations.</li> <li>2. Contact Honeywell Technical Assistance if the problem exists.</li> </ol>
Setup Error	The peer device indicated that one or more data item is not valid.	<p>The error will occur when an incompatibility exists between peer devices with regard to variable or signal assignments.</p> <p>This error should not occur when exchanging data between HC900 controllers.</p>	Contact Honeywell Technical Assistance if the status occurs.
Peer Fail	The assigned peer could not be located on the network.	N/A	<ol style="list-style-type: none"> <li>1. Check the controller name and network name of the peer device to assure that they match that specific PDE block.</li> <li>2. Check that the IP addresses of the peer devices are all within the range of the IP mask.</li> <li>3. Check that the peer devices have the same IP subnet mask. See Network parameters for IP mask setting.</li> </ol>
Port Fail	The peer data exchange IO subsystem could not be started due to internal resource problem.	N/A	<ol style="list-style-type: none"> <li>1. Reset the controller to restart the Ethernet IO hardware and reassign processor IO mapping.</li> <li>2. Contact Honeywell Technical Assistance if the problem exists.</li> </ol>

Value	Possible Cause	Controller Action	User Action
Not Started	The assigned peer IO connection has not yet been attempted. Normal state during startup and during configuration mode. This status should automatically change to GOOD after both peer controllers are in the RUN mode.	N/A	<ol style="list-style-type: none"> <li>1. If this status persists during run time, check that the peer device is properly connected and that the control name and network name is correct.</li> <li>2. Check that the IP masks of all peer devices to assure that all IP addresses are within the same subnet.</li> <li>3. Check that all external network components such as switches and routers allow passing of UDP packets on port 502.</li> <li>4. Check that the peer device is powered on and is in RUN mode.</li> </ol>

## Reports

### Print Report



Select "Print Report" from the File menu. If you selected the icon from the Custom Modbus Map toolbar it will print the currently displayed partition.



Print Report lets you print a report for various functions.

Click on the Icon on the toolbar and select a report from the drop-down menu that appears.

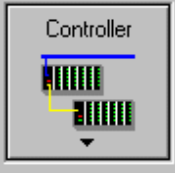
The "Print" dialog box will open to let you print a specific report.

You can also print a report from "Print Report Preview" from the File menu.

Toolbar Icon	Reports Available
	<p><b>E-Mail</b> - Shows how E-mail notification is configured.</p> <p><b>I/O Configuration</b> - Shows configuration of all I/O on all racks.</p>
	<p><b>All FBD Worksheets</b> - <i>Prints all active FBD worksheets) - not available in "Print Preview" mode.</i></p> <p><b>FBD Worksheet</b> - Select worksheet from drop-down list)- Shows the selected worksheet of the function block diagram.</p> <p><b>Block Parameters</b> - Shows a detailed report of each function block's parameters.</p> <p><b>Modbus Register Map (appears if using fixed map)</b></p> <p><b>Detailed Function Block Report</b> - Shows the starting address of each function block, as well as the addresses of all its parameters. Click here for details .</p> <p><b>Summary Function Block Report</b> - Shows the starting address of each function block. Click here for details</p> <p><b>User Defined Signals and Variables</b> - Shows the user-defined Modbus addresses of signals and variables.</p> <p><b>Modbus Map Partitions (appears if using custom map)</b> – Select a partition. Shows the addresses and contents of the selected partition.</p> <p><b>Summary Function Block Report (appears if using custom map)</b>- Shows the address of each function block in the custom map.</p> <p><b>Tag Information</b> - Shows a detailed report of signal tags and/or variables. Choose from Signal Tags, Variables, or Signal Tags and Variables. See sample of this report.</p> <p><b>Where Used</b> - Shows location (worksheet and page) of every item in the function block diagram.</p> <p><b>File statistics</b> - Shows useful file statistics. Schema # is a database revision code used by the controller, OI and the software to ensure compatibility.</p>
	<p><b>General Settings</b> – Shows Operator Interface settings (security, startup display, filenames).</p> <p><b>Help Screens</b> - Shows Operator Interface help screens.</p> <p><b>Assigned Display Keys</b> - Shows Operator Interface displays and contents for each display button.</p> <p><b>Data Storage Settings</b> - Shows data storage settings (trend group data points, batch enable, etc.)</p>

Toolbar Icon	Reports Available
	<p><b>Recipes (Variables)</b> – Shows contents of the selected recipe (variables, descriptions).</p> <p><b>Setpoint Profiles</b> - Shows contents of the selected Setpoint Profile.</p> <p><b>Setpoint Schedules</b> - Shows contents of the selected Setpoint Schedule.</p> <p><b>Sequences</b> - Shows contents of the selected Sequence.</p>
	<p><b>All Alarm Groups</b> - Shows contents of each Operator Interface alarm group display.</p> <p><b>All Events</b> – Shows all configured events and their triggers.</p>

### Sample report

Here is a sample report. All reports have a similar layout. You can also do a print report preview to see what a report looks like. Modbus addresses shown are the default addresses unless identified as user-defined addresses.

File Name: HC900-C50 Rev 2.0x : Config1 from FIVERACK on PEERNET *	Controller: FIVERACK	Title:	Author:
--	----------------------	--------	---------

### Signal Tag and Variable Information Report

Hex Addr	Dec Addr	Tag Name	Description	Type	#	Data Type	EU	Decimal Places	Tag Type	'On' Label	'Off' Label	Initial/Source
0x18C0	6337	VAR001		Variable	1	float 32		0	Analog			1.00
0x18C2	6339	VAR002		Variable	2	float 32		0	Analog			0.00
0x18C4	6341	VAR003		Variable	3	float 32		0	Analog			0.00
0x18C6	6343	VAR004		Variable	4	float 32		0	Analog			0.00
0x18C8	6345	VAR005		Variable	5	float 32		0	Analog			0.00
0x2000	8193	R1S1		Signal Tag	1	float 32			Digital	ON	OFF	Block 103 Output 1
0x2002	8195	R1S2		Signal Tag	2	float 32			Digital	ON	OFF	Block 106 Output 1
0x2004	8197	R1S3		Signal Tag	3	float 32			Digital	ON	OFF	Block 109 Output 1
0x2006	8199	R1S4		Signal Tag	4	float 32			Digital	ON	OFF	Block 112 Output 1
0x2008	8201	R1S5		Signal Tag	5	float 32			Digital	ON	OFF	Block 115 Output 1
0x200A	8203	R1S6		Signal Tag	6	float 32			Digital	ON	OFF	Block 118 Output 1
0x200C	8205	R1S7		Signal Tag	7	float 32			Digital	ON	OFF	Block 121 Output 1
0x200E	8207	R1S8		Signal Tag	8	float 32			Digital	ON	OFF	Block 124 Output 1
0x2010	8209	R1S9		Signal Tag	9	float 32			Digital	ON	OFF	Block 127 Output 1
0x2012	8211	R1S10		Signal Tag	10	float 32			Digital	ON	OFF	Block 130 Output 1
0x2014	8213	R1S11		Signal Tag	11	float 32			Digital	ON	OFF	Block 133 Output 1
0x2016	8215	R1S12		Signal Tag	12	float 32			Digital	ON	OFF	Block 136 Output 1
0x2018	8217	R2S1		Signal Tag	13	float 32			Digital	ON	OFF	Block 139 Output 1
0x201A	8219	R2S2		Signal Tag	14	float 32			Digital	ON	OFF	Block 142 Output 1
0x201C	8221	R2S3		Signal Tag	15	float 32			Digital	ON	OFF	Block 145 Output 1
0x201E	8223	R2S4		Signal Tag	16	float 32			Digital	ON	OFF	Block 148 Output 1
0x2020	8225	R2S5		Signal Tag	17	float 32			Digital	ON	OFF	Block 151 Output 1
0x2022	8227	R2S6		Signal Tag	18	float 32			Digital	ON	OFF	Block 154 Output 1
0x2024	8229	R2S7		Signal Tag	19	float 32			Digital	ON	OFF	Block 157 Output 1
0x2026	8231	R2S8		Signal Tag	20	float 32			Digital	ON	OFF	Block 160 Output 1
0x2028	8233	R2S9		Signal Tag	21	float 32			Digital	ON	OFF	Block 163 Output 1
0x202A	8235	R2S10		Signal Tag	22	float 32			Digital	ON	OFF	Block 166 Output 1
0x202C	8237	R2S11		Signal Tag	23	float 32			Digital	ON	OFF	Block 169 Output 1
0x202E	8239	R2S12		Signal Tag	24	float 32			Digital	ON	OFF	Block 172 Output 1
0x2030	8241	R3S1		Signal Tag	25	float 32			Digital	ON	OFF	Block 241 Output 1
0x2032	8243	R3S2		Signal Tag	26	float 32			Digital	ON	OFF	Block 242 Output 1
0x2034	8245	R3S3		Signal Tag	27	float 32			Digital	ON	OFF	Block 243 Output 1
0x2036	8247	R3S5		Signal Tag	28	float 32			Digital	ON	OFF	Block 245 Output 1
0x2038	8249	R3S6		Signal Tag	29	float 32			Digital	ON	OFF	Block 246 Output 1
0x203A	8251	R4S1		Signal Tag	30	float 32			Digital	ON	OFF	Block 253 Output 1
0x203C	8253	R3S7		Signal Tag	31	float 32			Digital	ON	OFF	Block 179 Output 17
0x203E	8255	R3S8		Signal Tag	32	float 32			Digital	ON	OFF	Block 180 Output 17
0x2040	8257	R3S9		Signal Tag	33	float 32			Digital	ON	OFF	Block 181 Output 17
0x2042	8259	R3S10		Signal Tag	34	float 32			Digital	ON	OFF	Block 182 Output 17
0x2044	8261	R3S11		Signal Tag	35	float 32			Digital	ON	OFF	Block 183 Output 17
0x2046	8263	R3S12		Signal Tag	36	float 32			Digital	ON	OFF	Block 184 Output 17
0x2048	8265	SP		Signal Tag	37	float 32		3	Analog			Block 102 Output 43
0x204A	8267	AUX		Signal Tag	38	float 32		0	Analog			Block 102 Output 44
0x204C	8269	STMR		Signal Tag	39	float 32		0	Analog			Block 102 Output 45
0x204E	8271	STME		Signal Tag	40	float 32		0	Analog			Block 102 Output 46

Created Date: 9/3/2002 1:11:46 PM	Modified Date: 7/17/2003 12:27:13 PM	Page: 1 of 2
-----------------------------------	--------------------------------------	--------------

## Print Report Preview

Lets you preview an on-screen version of any printable report.

See Print Report for available reports and their content.

Note: All FBD Worksheets not available in Print Preview mode.

### Navigation

A toolbar at the top of the report screen lets you navigate through the reports:

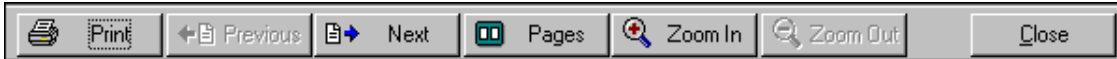

The functions from left to right are:

**Print** - prints the active report without going to "Print Report" in the file menu.

**Previous Page** - selects the previous page on the report for display

**Next Page** - selects the next page on the report for display

**Two Pages** - shows two report pages at once

**Zoom Out** - Makes the report larger on the screen

**Zoom In** - makes the report smaller on the screen

**Close** - closes the Print Report Preview

## Export Report

Select "Export Report" from the File menu or select the icon from the Custom Modbus Map toolbar. Export Report lets you export some reports as files in comma delimited (.csv) or tab delimited (.txt) format. The files contain the same data as shown in the printed report, just formatted differently. Exported reports can then be imported by other applications such as third party operator interface configurations.

Not all printable reports can be exported; choices are limited.

Click on the Icon on the toolbar and select a report from the drop-down menu that appears. Name the report and save it as .csv or .txt.

To change the default export file type, see Export Delimiter.

Exported Files have the following format for their Header sections.

<u>Header</u>	<u>Example</u>	<u>Description</u>
<b>RevisionID:</b>	0115.0030.0002.0002.0003	AAAA.BBBB.CCCC.DDDD.EEEE Where  AAAA = Export ID: 0103 = IO Configuration Information Report 0106 = Variable and Signal Tag Information Report 0115 = Modbus Address Detailed Report 0116 = User Defined Modbus Registers Report 0117 = Signal Tag Report 0118 = Variable Report 0119 = Modbus Address Summary Report 0120 = All Function Block Modbus Addresses 5000 = Modbus Partition Registers Report 5500 = All Modbus Registers Report  BBBB = Database Schema Number  CCCC = Product type: 2 = HC950 3 = HC930 4 = HC970R 5 = HC970  DDDD = Platform type: 2 = HC900 series controllers  EEEE = Feature Set: Schema database minor revisions
<b>File Name:</b>	HC900-C50 Rev 2.1x : jjpconfig1 C50_R2.1.cde	Device Type Device Revision: Configuration Filename
<b>Controller Name:</b>	JOE	Controller name assigned within the configuration
<b>Title:</b>	Joe's Furnace Control	Optional title or description for the configuration
<b>Author:</b>	Joe	Optional author or creator of the configuration
<b>Created Date:</b>	5/20/2005 13:09	Date when configuration file was first created
<b>Modified Date:</b>	5/30/2005 14:05	Date when configuration file was last modified and saved.
<b>Report Title:</b>	Modbus Address Detailed Report	Report title: IO Configuration Information Report Variable and Signal Tag Information Report Modbus Address Detailed Report User Defined Modbus Registers Report Signal Tag Report Variable Report Modbus Address Summary Report All Function Block Modbus Addresses Modbus Partition Registers Report – Partition Name All Modbus Registers Report



## Modbus Register Addresses

### Modbus Register Map Overview

Modbus addressing is available in revision 2.0 and later. The map is view-only in HC Utilities.

In your controller's configuration certain parameters are each automatically assigned a Modbus address. These include certain types of function blocks (such as loops and set point programmers), signals and variables, among other items. Through their addresses these parameters can be accessed or displayed remotely, such as by a third-party operator interface. Collectively, these Modbus addresses and parameters are known as the Modbus map. You can use a predefined fixed map where common parameters are mapped out automatically at fixed addresses, or you can create a custom map for configurations rev. 4.0 or higher.

### Fixed or custom map

There are two kinds of Modbus maps available: fixed or custom. Basically, the fixed and custom maps both can contain the same types of items but the custom map has more flexibility with those items' quantities, addresses and data types. The maps have these characteristics.

Fixed map	Custom map
The items that can be in the fixed map are limited to certain types of function blocks and other configuration data.	The items that can be in the custom map are limited to certain types of function blocks and other configuration data, same as fixed map.
Items are automatically assigned to the fixed map.	At the moment you switch from fixed to custom map mode, any items in your configuration maintain their addresses from the fixed map. However, once you are in custom map mode, if you add more items to your configuration they are not automatically added to the custom map, you must add them manually.
Each item type is grouped in a fixed address range of the map. For example, the address range designated for Loops is restricted to Loops only, it can not contain Setpoint Programmers.	You can create partitions with custom names and address ranges. Partitions can contain any item types, you can mix and match items if needed.
Quantities of each item type are at a fixed maximum (such as 32 loops, 8 programmers). Good for smaller configurations or pre-4.0 configurations. If your configuration exceeds these maximums a message reminds you to consider switching to the custom map.	Quantities are limited only by the amount of free space in the map or partition. Use custom map when you need to access data from more than 32 loops, for example.
Every parameter of a function block is automatically added to the map. You don't need to specify which of the block's parameters are mapped, they're all there. For example, all of a PID block's 40-plus parameters are added to the map.	Lets you pick and choose which block parameters to add. For example, a PID block contains over 40 parameters. The fixed map adds them all; the custom map lets you add only the ones you need to access, thus freeing up more addresses for other parameters. You can create templates to apply to any or all function blocks of a type. For example, you can select 5 of a PID block's parameters then save them to a PID template. You can load that template into other PID blocks so they each address the same

Fixed map	Custom map
	5 parameters.
You can reorder items within a group, such as switching Loop 1 with Loop 10. You can assign signals and variables to a user-defined area of the map.	You can reorder items. More generally you can put any parameter at any address or at multiple addresses or partitions.
The fixed map has a fixed range (45057-46056) for assigning configured signal tags and variables to another data type, such as integer 16.	The custom map lets you assign any data type to any address (float 32, integer 16, etc.). A default data type is applied but can be changed.
The fixed map contains several gaps of unused (and unusable) addresses.	Since you can put any parameter at any address you can eliminate gaps of unused addresses, thus increasing the map's capacity.
The fixed map is the default map for all configurations. Unless and until you switch to the custom map, the fixed map is in use. Items are automatically added to the map when you access the map, up to the quantity limits (such as 32 loops, 8 programmers). The only items that are not automatically added are user-defined signals and variables.	Uses the fixed map as a starting point*. Any edits to the fixed map (such as reordered items within a group or user-defined signals and variables) are carried over when you switch to the custom map. The custom map's default partitions are based on the fixed map's groups. Conversely, if you switch from custom map to fixed map, any customized partitions or addresses are lost.  *You can revert to this starting point at any time by using the Replace feature in the custom map.

## Fixed Map

### Overview

Certain items in your configuration are automatically assigned Modbus addresses in the fixed Modbus map. These items include signal tags, variables and principal function blocks like loops and setpoint programmers. As each item is added to your configuration it is assigned to the first (lowest) available Modbus address within the range reserved for that item type. If you delete an item from your configuration it is removed from that Modbus address and that address becomes available for another item.

Also available is a range of 1000 addresses (45057 for assigning user-defined signal tags and variables to any address or multiple addresses. Within these 1000 addresses the data type of each signal tag or variable can be changed, for example, from float 32 to integer 16.

### Access

To access the fixed Modbus register map to view an address, select the main menu Edit item, Edit Fixed Modbus Register Map, or right-click on a configured signal, variable, or function block. The map is view-only in HC Utilities.

The following tabs are presented.

#### User Defined Signals and Variables Tab

Select an address range. There are 20 ranges of 50 addresses each for a total of 1000 addresses.

To view all addresses of an item, display its Properties.

- Signal Tag Properties
- Variable Properties

**Function Blocks Tab**

Procedure for viewing function block addresses.

Use Filter to list all configured function blocks of a certain type. Types are:

Loops (PID, On-Off, Carbon Potential, 3 Position Step, Auto-Manual Bias)

Alternator

Hand/Off/Auto Switch

Sequencer

Setpoint Programmer

Setpoint Scheduler

Stage

Device Control

Ramp

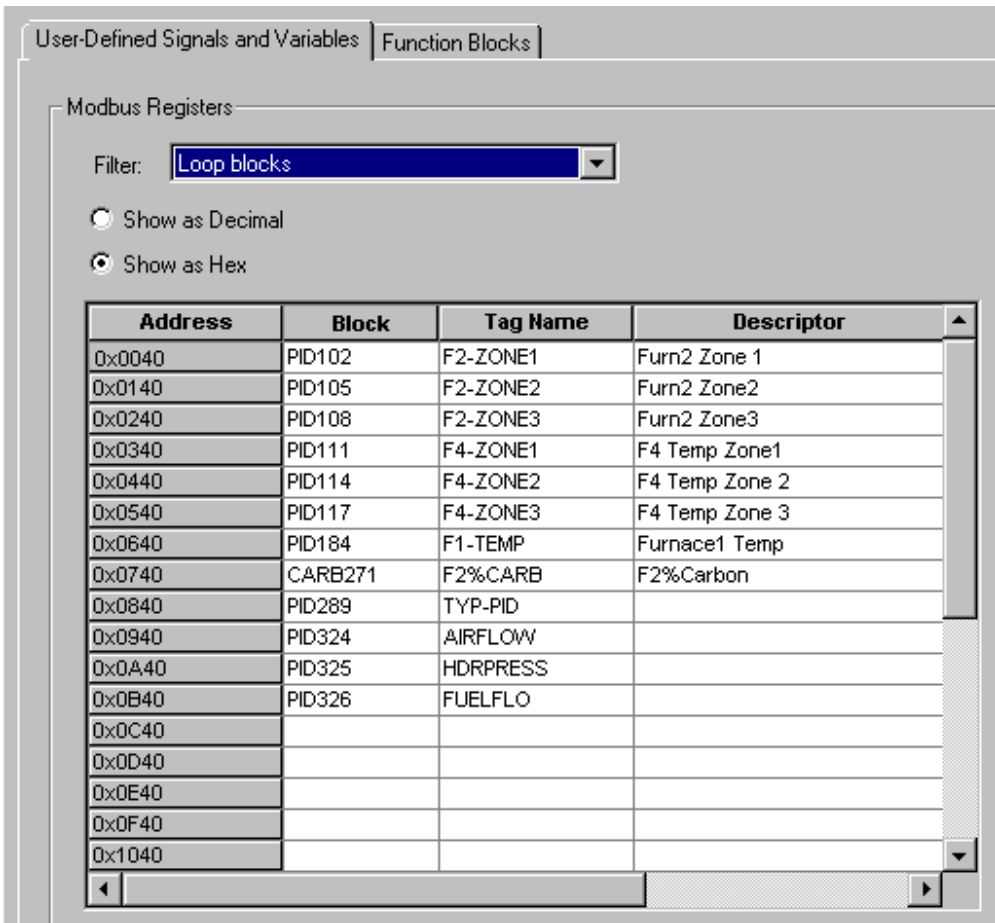

Addresses containing that type of function block are shown in numerical order.

Unlike signals and variables, only one Modbus address is allowed per function block.

To view the address of any function block, display its Properties by right-clicking on the function block in the configuration diagram under the Controller tab.

## Custom Map

### Access

To access the custom Modbus register map to view an address, click on the Modbus Map tab at the bottom of the display. This tab is visible only after you configure your map type as custom.

The map is view-only in HC Utilities.

### Overview

The custom Modbus map is applicable to the array of Modbus registers classified as "holding registers" or "4xxxx" registers using decimal addressing where "xxxxx" equals the Modbus address ranging from 1-65535 decimal (0-FFFE hex).

### Working with partitions

You can view addresses in defined partitions only. Addresses in undefined partitions are not available until you create a new partition with those addresses. Partitions need not be empty to be edited. If you need more addresses in a partition you can combine it with adjacent partitions, or resize it using space from an adjacent undefined partition.

### Functions

Function	Description
Select a partition	You must select a partition whose contents you want to display. The map takes a few seconds to build the contents. Default partitions are based on the fixed map.
Currently displayed partition	Name of the current partition. See Select a partition.
Show Register Address as	Select whether to display addresses in hexadecimal or decimal.
Item	View only. Block name or signal/variable name.
Parameter Name	View only. If the item is a function block this is the parameter name. If the item is a signal tag or variable this is the tag name.
Description	Read only. Description of signal tag or variable.
Data Type	View only. Choices: Unsigned 16 Signed 16 Unsigned 32 (requires 2 registers) Signed 32 (requires 2 registers) Float 32 (requires 2 registers)  If 2 registers are required the higher register is grayed out and not assignable. Note: For signals and variables, when changing data type from float 32 to integer 16, keep in mind the decimal point location. For example, 1000.1 translates to 10001. Note: For function blocks, when changing data type from float 32 to integer 16, the value is rounded. For example, 1000.1 translates to 1000 and 1000.5 translates to 1001.
Decimals	Read only. Decimal places of signal tag or variable.
R/W	View only. Type of access to the parameter. ReadWriteRead/Write
Register	Number of the address in decimal or hex.

---

Function	Description
Horizontal Scroll	Use to scroll to offscreen areas of the map.
Vertical Scroll	Lets you scroll through the partition.
Toolbar	Print a Partition Report. Export a Partition Report. Lock/unlock Worksheet

**Further information**

For details on Modbus parameters, see the HC900 Hybrid Controller Communications User Guide, document number 51-52-25-111.



## Redundancy

C70R controllers/networks have their own diagnostics that are accessed under

[Utilities Worksheet Overview](#)

[Monitor Menu](#)

Redundancy diagnostics are grouped as follows.

[Redundancy System](#)

[Redundancy Link](#)

[Lead CPU](#)

[Reserve CPU](#)

[Scanner 2 Link](#)

## Redundancy System Status Indicators

The Redundancy System Diagnostics dialog box will provide status of the parameters shown in the following list.

Parameter	Value	Possible Cause	Controller Action	User Action
Redundancy Status	Available	Normal operation	N/A	N/A
	No RSM module detected	Switch on RSM is set between two positions. RSM Module is not inserted RSM Module has failed	The controller will continue to operate with a missing RSM. Automatic failover is still possible if required.	Make sure switch is in desired position Install RSM module Replace RSM
	RSM switch is bad	RSM Switch is indicating an invalid position	The controller will continue to operate with a bad RSM. Automatic failover is still possible if required.	Replace RSM
	I/O comm error on reserve	Reserve CPU is unable to communicate with one or more of the I/O racks.	The lead controller will continue to control the process. Failover to the reserve is still possible if a subsequent failure renders the current lead less capable than the reserve.	Verify all cabling between the reserve CPU and the scanners. Replace any Ethernet switches between the reserve CPU and the I/O rack(s). Replace the reserve CPU Replace the scanner CPU Contact Honeywell service
	Database Not Synchronized	Hardware failure on the reserve CPU Hardware failure on the lead CPU Hardware failure on the	The lead controller will continue to control the process, but failover is not possible.	Replace the reserve CPU Replace the lead CPU Replace the CPU rack backplane

Redundancy  
Redundancy Link Status Indicators

Parameter	Value	Possible Cause	Controller Action	User Action
		CPU rack backplane		Contact Honeywell service
	Invalid Configuration	Neither CPU has a valid configuration database	An empty database is created.	Download the desired configuration file and perform a cold start.
	Firmware Version Mismatch	The reserve controller does not have the same version of controller firmware installed	The lead controller will continue to control the process, but failover is not possible.	Upgrade the CPU firmware so both the lead and reserve have the same version.
Redundancy Diagnostics	Good			
	Database Not Synchronized	Hardware failure on the reserve CPU Hardware failure on the lead CPU Hardware failure on the CPU rack backplane	The lead controller will continue to control the process, but failover is not possible.	Replace the reserve CPU Replace the lead CPU Replace the CPU rack backplane Contact Honeywell service
	Invalid Configuration	Neither CPU has a valid configuration database	An empty database is created.	Download the desired configuration file and perform a cold start.
	Firmware Version Mismatch	The reserve controller does not have the same version of controller firmware installed	The lead controller will continue to control the process, but failover is not possible.	Upgrade the CPU firmware so both the lead and reserve have the same version.

## Redundancy Link Status Indicators

The Redundancy Link Diagnostics dialog box will provide status of the parameters shown in the following list.

Parameter	Value	Possible Cause	Controller Action	User Action
Redundancy Link Port Status	Good	Lead and Reserve CPUs working ok	N/A	N/A
	Reserve not present	Reserve CPU module is not plugged in.	N/A	Install Reserve CPU
	Reserve Bad Comm	Reserve CPU module is plugged in but not communicating.	Reserve or Lead CPU module could be bad. Backplane could be bad.	Replace faulty CPU. Replace rack.
	Hardware failure	Bad Lead module Bad backplane	N/A	Replace faulty CPU. Replace rack.
Redundancy Link	Good	N/A	N/A	N/A

Parameter	Value	Possible Cause	Controller Action	User Action
Port Diagnostics	Data Link Failure	Reserve CPU module is not plugged in.  Reserve CPU module is plugged in but not communicating.	The lead CPU will continue to control the process but failover is not possible.	Replace faulty CPU  Replace rack
	Hardware Failure	Bad Redundancy link hardware detected on the lead CPU	The lead CPU will continue to control the process but failover is not possible.	Replace faulty CPU

## Lead CPU Status Indicators

The Lead Diagnostics Overview dialog box will provide status of the parameters shown in the following list. These parameters are also shown for the Reserve Diagnostics Overview.

Parameter	Status	Possible Cause	Controller Action	User Action
CPU Diagnostics	Good	N/A	N/A	N/A
	Watchdog	Watchdog reset resulting from software failure	ASYS block's HW OK pin is turned off.	Force a cold start.  Upgrade control file software.  Replace CPU board.  Contact Honeywell Personnel.
	Prefetch Abort	CPU failed when attempting to fetch an instruction from the prefetch register.	Controller performs a restart  ASYS block's HW OK pin is turned off.	Force a cold start.  Isolate system from noise and force a cold start.  Replace CPU board
	Address Error	The reserved exception occurred for an unknown reason.	Same as above	Same as above
	Undefined Error	Bad Instruction Detected	Same as above	Same as above
	Data Abort	CPU failed when attempting to access data.	Same as above	Same as above
	Software Interrupt Error	Software Interrupt occurred which is not supported by the software.	Same as above	Same as above
	Good	N/A	N/A	N/A

Redundancy  
Lead CPU Status Indicators

Parameter	Status	Possible Cause	Controller Action	User Action
	Watchdog	Watchdog reset resulting from software failure	ASYS block's HW OK pin is turned off.	Force a cold start. Upgrade control file software. Replace CPU board. Contact Honeywell Personnel.
Memory Diagnostics	Good	N/A	N/A	N/A
	5 Day Low Battery Warning	Estimated battery life is less than 5 days.	ASYS block's HW OK pin is turned off.	Replace battery.
	Low Battery	Battery voltage is low.	ASYS block's LOW BATTERY pin is turned on. ASYS block's HW OK pin is turned off.	Replace battery.
	Flash Error	Flash failed to burn	ASYS block's HW OK pin is turned off.	Force a cold start. Replace CPU board.
Real-time Clock Diagnostics	Good	N/A	N/A	N/A
	Not Programmed	RTC not programmed	1. Time and date is set to 00:00:00, January 1, 1970. 2. ASYS block's HW OK pin is turned off.	<u>Program RTC.</u>
	Bad Data	Bad date and time	Same as above	<u>Program RTC.</u> Cycle power. Replace CPU. Replace boards in rack. Replace rack
	Programming Failure	RTC failed to program	Same as above	Same as above
	Read Failure	Unable to read RTC	Same as above	Same as above
Port S1/S2 Diagnostic	Good	N/A	N/A	N/A

Parameter	Status	Possible Cause	Controller Action	User Action
	Data Link Error	A large number of messages are resulting in data link errors.	SYSTEM MONITOR block's HW OK pin is turned off.	<ol style="list-style-type: none"> <li>1. Check baud rate.</li> <li>2. Check connectors.</li> <li>3. Check cable polarity.</li> <li>4. Isolate cable from electrical interference.</li> <li>5. If RS232-to-RS485 converter used, check its power, switch/jumper settings, and polarity.</li> </ol>
	Hardware Failure	The UART is failing to operate properly.		Replace the controller CPU module.
Lead Port E1/E2: Network Port Diagnostics	Good	N/A	N/A	N/A
	Hardware Failure	Ethernet port tests failed during power-up.	Same as above	Replace CPU module
Rack Comm Diagnostic	Good	See <a href="#">Expansion I/O Comm Diagnostics Status Indicators</a>		
	Data Link Failure	See <a href="#">Expansion I/O Comm Diagnostics Status Indicators</a>		
	Hardware Failure	See <a href="#">Expansion I/O Comm Diagnostics Status Indicators</a>		
	Port A/B Cable Mismatch	See <a href="#">Expansion I/O Comm Diagnostics Status Indicators</a>		
	Protocol Mismatch	See <a href="#">Expansion I/O Comm Diagnostics Status Indicators</a>		
Scanner2 Rack n Network Status	No Comm	See <a href="#">Scanner 2 Link Status Indicators</a> .		
	Marginal - Port I/O A	See <a href="#">Scanner 2 Link Status Indicators</a> .		
	Marginal - Port I/O B	See <a href="#">Scanner 2 Link Status Indicators</a> .		
	Good - Port I/O A	See <a href="#">Scanner 2 Link Status Indicators</a> .		
	Good - Port I/O B	See <a href="#">Scanner 2 Link Status Indicators</a> .		

Redundancy  
Lead CPU Status Indicators

Parameter	Status	Possible Cause	Controller Action	User Action
	Not in Configuration	See <a href="#">Scanner 2 Link Status Indicators</a> .		
Scanner2 Rack n Network Diagnostics	Good	See <a href="#">Scanner 2 Link Status Indicators</a> .		
	Data Link Failure	See <a href="#">Scanner 2 Link Status Indicators</a> .		
	Hardware Failure	See <a href="#">Scanner 2 Link Status Indicators</a> .		
	Port A/B Cable Mismatch	See <a href="#">Scanner 2 Link Status Indicators</a> .		
	Protocol Mismatch	See <a href="#">Scanner 2 Link Status Indicators</a> .		
CPU Slot Position	CPU A	CPU A is the Lead/Reserve.	N/A	N/A
	CPU B	CPU B is the Lead/Reserve.	N/A	N/A
	CPU is missing	Reserve CPU is not installed or not powered.  CPU rack backplane failure.	The lead CPU will continue to control the process but failover is not possible.	Install reserve CPU.  Apply power to reserve CPU.  Replace CPU rack backplane.  Call Honeywell service.
Power Supply Type	Unknown	CPU cannot identify the Power Supply Type	None	None
	24VDC	CPU identified a 24VD DC power supply	None	None
	Low Wattage	CPU identified a Low wattage power supply	None	None
	High Wattage	CPU identified a High wattage power supply	None	None

## Reserve CPU Status Indicators

Contains same information as for the [Lead CPU Status Indicators](#).

## Scanner 2 Link Status Indicators

The Redundancy Scanner 2 Link Diagnostics dialog box will provide status of the parameters shown in the following list.

Parameter	Value	Possible Cause	Controller Action	User Action
Scanner-2 Network Status	No Comm	Controller is communicating to none of the Scanner 2s that are in the configuration.  or  Controller may be communicating to a Scanner 2 that is not in the configuration	If scanners are in the configuration, see <a href="#">Expansion Rack Link Diagnostics</a> below.	See <a href="#">Expansion Rack Link Diagnostic</a> below.
	Marginal - Port I/O A	Controller is experiencing marginal communications on the respective Scanner 2 link to one or more Scanner 2s in the configuration  and/or  Controller is communicating to some of the Scanner 2s in the configuration but not all	If a scanner 2 in the configuration is not communicating, then a communication diagnostic is posted for that rack. Refer to the <a href="#">Expansion I/O Comm Diagnostic Summary</a> dialog box	Refer to the <a href="#">Expansion I/O Comm Diagnostic Summary</a> dialog box
	Marginal - Port I/O B	Controller is experiencing marginal communications on the respective Scanner 2 link to one or more Scanner 2s in the configuration  and/or  Controller is communicating to some of the Scanner 2s in the configuration but not all	Same as above	Same as above
	Good - Port I/O A	Controller is experiencing good communications on the respective	Lead CPU is operating normally using the I/O Port A to communicate with the Scanner Racks	none

## Redundancy

Parameter	Value	Possible Cause	Controller Action	User Action
		Scanner 2 link. Scanner 2s not in the configuration have no effect on the status		
	Good - Port I/O B	Controller is experiencing good communications on the respective Scanner 2 link. Scanner 2s not in the configuration have no effect on the status	Lead CPU is operating normally using the I/O Port B to communicate with the Scanner Racks	none
	Not in Configuration	No Scanner 2s in the configuration	N/A	N/A
Expansion Rack Link Diagnostics	Good		N/A	N/A
	Data Link Failure	The ratio of the number of data link errors and the number of good messages exceeds a certain threshold	See the "Rack Comm Diagnostics" parameter in the <a href="#">Expansion I/O Comm Diagnostic Summary</a> dialog box	See the "Rack Comm Diagnostics" parameter in the <a href="#">Expansion I/O Comm Diagnostic Summary</a> dialog box
	Hardware Failure	The expansion I/O port's hardware is indicating a failure	See the "Rack Comm Diagnostics" parameter in the <a href="#">Expansion I/O Comm Diagnostic Summary</a> dialog box	See the "Rack Comm Diagnostics" parameter in the <a href="#">Expansion I/O Comm Diagnostic Summary</a> dialog box
	Port A/B Cable Mismatch	At least one Scanner 2 has its A and B ports swapped with the Lead and Reserve	See the "Rack Comm Diagnostics" parameter in the <a href="#">Expansion I/O Comm Diagnostic Summary</a> dialog box	See the "Rack Comm Diagnostics" parameter in the <a href="#">Expansion I/O Comm Diagnostic Summary</a> dialog box

## Index

<b>A</b>	
Accessing Port Diagnostics	160
Alarm/Event Storage Configuration	65
Auto Calibration Procedure	90
<b>B</b>	
Backup Controller Information	82
Batch File Management	101
<b>C</b>	
Calibrate AI Channel	87
Calibrate AO Channel	88
Calibrate CJ Temp	87
Calibrate Modules	86
Calibrate Position Proportional Output	89
Closing a Menu	16
Communications Statistics	44
Configuration File	29
Saving	29
Configuration Functions	103
Configuration Overview	96
Configuration Port Diagnostics	160
Configuration Port Diagnostics Status Indicators	161
Connecting the PC to the Controller	8
Connectors	132
Context Sensitive Help	67
Controller Configuration Toolbar	51
Controller Diagnostics	143
Controller Diagnostics Status Indications	145
Controller Identification	76
Controller Port Diagnostics	161
Controller to PC Connection Settings	42
Controller Utility Functions	69
Converting a UMC800 Database	30
Copy	19
Create/edit Data Storage File	60
Create/edit Recipe-Variables-File	104
Create/edit Schedule file	113
Create/edit Sequence File	117
Create/edit Setpoint Profile File	107
Cut	19, 26, 67
<b>D</b>	
Data Storage Configuration	60
Data Storage Configuration Access	60
Data Storage Conventions	53
Data Storage Enable Conditions	56
Data Storage File	60
Data Storage Overview	53
Data Storage Utility	81
Diagnostics	86, 143, 145, 151, 155, 156, 160, 161, 163, 164, 165, 166, 167, 168, 169, 172
configuration port	160, 161
controller	143, 145
expansion I/O comm	166, 167
host connections	168, 169
I/O module	155, 156
network port	164, 165
peer to peer	172
port	160
rack	151
RS485 OI port	163
Displaying Function Block Pin Value	133
Download Firmware Error Messages	38
Downloading a File to the Controller	34
Downloading Controller Firmware	36
<b>E</b>	
Edit Menu	19
E-Mail Notification	51
Enter Monitor Mode	125
Expansion Port Diagnostics	166
Expansion Port Diagnostics Status Indicators	167
Export Delimiter	19
Export Report	175
<b>F</b>	
File Browser Window	11
File Properties	38
File Protection	38
File Read Protection	38
Find Feature	137
Find Where Used	26, 67
Finding a Tag Name	137
Finding an Item on the FBD Worksheet	137
Forced Blocks Window	130
Function block	133
how to display pin value	133
Function Block Monitor Window	128
<b>H</b>	
Hand Calibration Procedure	92
Host Connections Diagnostics	168
Host Connections Diagnostics Status Indicators	169
How Do I Start Monitoring	127
How Do I Stop Monitoring	130
How to Manage PC Comm Ports and Connections	39

<b>I</b>		Peer-to-Peer Connections Diagnostics Status Indicators	172
I/O Module Diagnostics Status Indications	155, 156	Pin Value	133
<b>K</b>		Point Log Storage Configuration	62
Keyboard Navigation	27	Position Proportional Output Calibration	89
<b>L</b>		PPO Block Auto Calibration	90
Logic Inversion Color Codes	134	PPO Block Calibration	89
<b>M</b>		PPO Block Hand Calibration	92
Main Menu	16	PPO Block Semi-Auto Calibration	91
Main Menus	16	Print Report	172
Main Toolbar Functions	24	Print Report Preview	174
Manually Write Database to Flash	85	<b>R</b>	
Menu	15, 16	Rack Module and Channel Assignments	5
Closing	16	Rack Diagnostics	151
Selecting	16	Rack Diagnostics Power Supply	153
Menu Conventions	15	Recipe	105
Modbus Address	177	Setup/Edit	105
edit	177	Recipe Configuration Overview	103
view	177	Recipe Overview	101
Modbus Register Map	177	Recipe Pool	105
edit	177	Recipe Properties	106
view	177	Recipes Menu	23, 102
Monitor menu	22	Recipe-Variables	103
Monitor Mode	125	configuration overview	103
indicator	125	Recipe-Variables- File	104
Monitor Toolbar	126	Redo	19
Monitor Update Rate	125	Remote Loopback Test	43
Monitoring	123, 127, 130	Report	172, 174, 175
how to start	127	Export	175
how to stop	130	Preview	174
<b>N</b>		Print	172
Navigational Tools	26	Restore Controller Information	83
Network Port Diagnostic Status Indicators	165	Restore Factory Calibration	89
Network Port Diagnostics	164	Right Mouse Click	26, 67
<b>O</b>		RS485 OI Port Diagnostics	163
Overview	130	RS485 OI Port status Indicators	164
Logic Flow	130	<b>S</b>	
Overview On Line Monitoring	123	Saving A Configuration File	29
<b>P</b>		Saving A Function Block Diagram	29
Page connectors	132	Select the Number to Call	44
Paste	19, 26, 67	Selecting a Menu	16
PC Comm ports and connection	39	Semi-Auto Calibration Procedure	91
how to manage	39	Sequence	119
PC Network Port Set Up For Controller Access	39	setup/edit	119
PC Serial Com Port Setup	41	Sequence File	117
PC to Controller Connection Settings	42	Sequence Pool	119
Peer-to-Peer Connections Diagnostics	172	Sequence Properties	120
		Sequencer Configuration Overview	99
		Serial ports	71
		set controller serial ports	71
		Set Controller IP Address	75
		Set Controller Mode	75
		Set Controller Network Parameters	75

Set Controller Time	78	Converting	30
Set Instrument Time	78	Undo	19
Set Serial Port	71	Unlock the Worksheet	51
Setpoint Profile	107, 110	Uploading a File from the Controller	31
properties	110	Utilities Worksheet Overview	69
Setpoint Profile Pool	110		
Setpoint Profile Properties	110	<b>V</b>	
Setpoint Program	94, 96	Variables	67
configuration	96	View Menu	21
What is	94	Visual Indicators for Monitor Mode	125
Setpoint Schedule File	113		
Setpoint Schedule Overview	98	<b>W</b>	
Setpoint Schedule Pool	116	Watch Summary - Display Groups	141
Setpoint Schedule Properties	117	Watch Summary - Inputs/Outputs	140
Setup/Edit a Recipe	105	Watch Summary - Page Connectors	139
Setup/Edit Sequence	119	Watch Summary - Signals	139
Signal Tags	132	Watch Summary - User Defined	137
Sort Function	137	Watch Summary - Variables	140
Starting the Application	7	Watch Summary Window	14, 136
Status Bar	15	Watch Window	12
		What is Sequence Control	99
<b>T</b>		What is Sequence Control?	99
Terms and Definitions	93	Window Menu	24
To Use This Help	4	Worksheet	47, 51
Traceback Window	12	unlock	51
Trend Storage Configuration	61	What is	47
		Worksheet Category Tabs	48
<b>U</b>		Worksheet Overview	69
UMC800 Database	30	Write Protect a File	38

## Sales and Service

For application assistance, current specifications, pricing, or name of the nearest Authorized Distributor, contact one of the offices below.

### ASIA PACIFIC

**Control Products**  
Asia Pacific Headquarters  
Phone: +(65) 6355-2828  
Fax: +(65) 6445-3033

### Asia Pasific Global Technical Support

**Field Instruments**  
Phone: +65 6580 3156  
Fax: +65 6445-3033  
**Process Instruments**  
Phone: (603) 76950 4777  
Fax: (603) 7958 8922

### Australia

Honeywell Limited  
Phone: +(61) 7-3846 1255  
FAX: +(61) 7-3840 6481  
Toll Free 1300-36-39-36  
Toll Free Fax: 1300-36-04-70

### China – PRC - Beijing

Honeywell China Inc.  
Phone: +(86-10) 8458-3280  
Fax: +(86-10) 8458-4650

### China – PRC - Shanghai

Honeywell China Inc.  
Phone: (86-21) 5257-4568  
Fax: (86-21) 6237-2826

### China – PRC - Chengdu

Honeywell China Inc.  
Phone: +(86-28) 8678-6348  
Fax: +(86-28) 8678-7061

### China – PRC - Xi'an

Honeywell China Ltd - Xi'an.  
Phone: +(86-29) 8833-7490  
Fax: +(86-29) 8833-7489

### China – PRC - Shenzhen-

Honeywell China Inc.  
Phone: +(86) 755-2518-1226  
Fax: +(86) 755-2518-1221

### Indonesia

PT Honeywell Indonesia  
Phone: +(62) 21-535-8833  
FAX: +(62) 21-5367 1008

### India Automation India Ltd.

Honeywell Ltd.  
Phone: +(91) 5603-9400  
Fax: +(91) 5603-9600

### Japan

Honeywell Inc.  
Phone: +(81) 3 6730 7150  
Fax: +(81) 3 6730 7228

### Malaysia

Honeywell Engineering Sdn Bhd  
Phone: +(60-3) 7950-4776  
Fax: +(60-3) 7958-8922

### New Zealand

Honeywell Limited  
Phone: +(64-9) 623-5052  
Fax: +(64-9) 623-5060  
Toll Free (0800) 202-088

### Philippines

Honeywell Systems (Philippines) Inc.  
Phone: +(63-2) 633-2830-31/  
636 1661-62  
Fax: +(63-2) 638-4013

### Singapore

Honeywell Pte Ltd.  
Phone: +(65) 6580 3278  
Fax: +(65) 6445-3033

### South Korea

Honeywell Korea Co Ltd  
Phone: +(822) 799 6315  
Fax: +(822) 792 9015

### Thailand

Honeywell Systems (Thailand) Ltd.  
Phone: +(662) 693-3099  
FAX: +(662) 693-3089

### Taiwan R.O.C.

Honeywell Taiwan Ltd.  
Phone: +(886-2) 2245-1000  
FAX: +(886-2) 2245-3241

### SE Asia Countries

see Honeywell Pte Ltd (Singapore) for:  
Pakistan  
Cambodia  
Guam  
Laos  
Myanmar  
Vietnam  
East Timor

### SE Asia Countries

see Honeywell Automation India Ltd for:  
Bangladesh  
Nepal  
Sri Lanka

## EUROPE

### Austria

Honeywell Austria GmbH  
Phone: +43 (316)400123  
FAX: +43 (316)40017

### Belgium

Honeywell SA/NV  
Phone: +32 (0) 2 728 24 07  
FAX: +32 (0) 2 728 22 45

### Bulgaria

Honeywell EOOD  
Phone: +(359) 2 40 20 900  
FAX: +(359) 2 40 20 990

### Czech Republic

Honeywell spol. s.r.o.  
Phone: +420 242 442 232  
FAX: +420 242 442 131

### Denmark

Honeywell A/S  
Phone: +(45) 39 55 55 55  
FAX: +(45) 39 55 55 58

### Finland

Honeywell OY  
Phone: +358 (0) 20752 2753  
FAX: +358 (0) 20752 2751

### France

Honeywell SA  
Phone: +33 (0)1 60198075  
FAX: +33 (0)1 60198201

### Germany

Honeywell AG  
Phone: +49 (69)8064336  
FAX: +49 (69)806497336

### Hungary

Honeywell Kft.  
Phone: +36-1-451 4300  
FAX: +36-1-451 4343

### Italy

Honeywell S.p.A.  
Phone: +39 02 92146 307/  
395  
FAX: +39 0292146377

### The Netherlands

Honeywell B.V.  
Phone: +31 (0) 20 5656200  
FAX: +31 (0) 20 5656210

### Norway

Honeywell A/S  
Phone: (45) 39 55 55 55

### Poland

Honeywell Sp. zo.o  
Phone: +48-22-6060900  
FAX: +48-22-6060901

### Portugal

Honeywell Portugal Lda  
Phone: +351 21 424 5000  
FAX: +351 21 424 50 99

### Romania

Honeywell Bucharest  
Phone: +40 (0) 21 2316437  
FAX: +40 (0) 21 2316439

### Russian Federation (RF),

ZAO "Honeywell"  
Phone: +7 (095) 796 98 00  
FAX: +7 (495) 797 99 64

### Slovak Republic

Honeywell s.r.o.  
Phone: +421-2-58247 410  
FAX: +421-2-58247 415

### Spain

Honeywell S.A.  
Phone: +34 (0)91313 61 00  
FAX: +34 (0)91313 61 30

### Sweden

Honeywell AB  
Phone: +(46) 8 775 55 00  
FAX: +(46) 8 775 56 00

### Switzerland

Honeywell AG  
Phone: +41 18552448  
FAX: +(41) 1 855 24 45

### Turkey

Honeywell Turkey A.S.  
Phone: +90 216 578 71 00  
FAX: +90 216 575 66 35

### Ukraine

Honeywell  
Tel: +380-44-201 44 74  
Fax: +380-44-201-44-75

### United Kingdom

Honeywell Control Systems Ltd.  
Phone: +44 (0)1344 655251  
FAX: +44 (0) 1344 655554

## MIDDLE EAST

### Abu Dhabi U A E

Middle East Headquarters  
Honeywell Middle East Ltd.  
Phone: +971 2 4041246  
FAX: +971 2 4432536

### Sultanate of Oman

Honeywell & Co Oman LLC  
Phone: +968 24 701153/  
Ext.33  
FAX +968 24 787351

### Saudia Arabia

Honeywell Turki Arabia Ltd  
**Jubail Office**  
Phone: +966-3-341-0140  
Fax: +966-3-341-0216  
Honeywell - ATCO  
**Dammam Office**  
Phone: 0096638304584  
Fax: 0096638338059

### Kuwait

Honeywell Kuwait KSC  
Phone: +965 242 1327 to 30  
Fax: +965 242 8315  
and  
Phone: +965 326 2934/1821  
Fax: +965 326 1714

## AFRICA

### Mediterranean & African Distributors

Honeywell SpA  
Phone: +39 (02) 250 10 604  
FAX: +39 (02) 250 10 659

### South Africa (Republic of) and sub saharan

Honeywell Southern Africa  
Honeywell S.A. Pty. Ltd.  
Phone: +27 11 6958000  
FAX +27 118051504

## NORTH AMERICA

### Canada

Honeywell LTD  
Phone: 1-800-737-3360  
FAX: 1-800-565-4130

### USA

Honeywell Process Solutions,  
Phone: 1-800-343-0228  
FAX: 1-717-771-8251  
Email:sc-cp-appssales@honeywell.com

## LATIN AMERICA

### Argentina

Honeywell S.A.I.C.  
Phone: +(54-11) 4383-3637  
FAX: +(54-11) 4325-6470

### Brazil

Honeywell do Brasil & Cia  
Phone: +(55-11) 7266-1900  
FAX: +(55-11) 7266-1905

### Chile

Honeywell Chile, S.A.  
Phone: +(56-2) 233-0688  
FAX: +(56-2) 231-6679

### Mexico

Honeywell S.A. de C.V.  
Phone: +(52) 55 5259-1966  
FAX: +(52) 55 5570-2985

### Puerto Rico

Honeywell Inc.  
Phone: +(809) 792-7075  
FAX: +(809) 792-0053

### Trinidad

Honeywell Inc.  
Phone: +(868) 624-3964  
FAX: +(868) 624-3969

### Venezuela

Honeywell CA  
Phone: +(58-2) 238-0211  
FAX: +(58-2) 238-3391



**Honeywell**

---

**Honeywell Process Solutions**

512 Virginia Drive

Fort Washington, PA 19034

<http://hpsweb.honeywell.com>

51-52-25-126 06.09 Printed in USA