

Ultrasonic Transmitters

THE PROBE

Operating Instructions · 03/2010



SIEMENS

Safety Guidelines: Warning notices must be observed to ensure personal safety as well as that of others, and to protect the product and the connected equipment. These warning notices are accompanied by a clarification of the level of caution to be observed.

Qualified Personnel: This device/system may only be set up and operated in conjunction with this manual. Qualified personnel are only authorized to install and operate this equipment in accordance with established safety practices and standards.

Unit Repair and Excluded Liability:

- The user is responsible for all changes and repairs made to the device by the user or the user's agent.
- All new components are to be provided by Siemens Milltronics Process Instruments Inc.
- Restrict repair to faulty components only.
- Do not reuse faulty components.

Warning: Cardboard shipping package provides limited humidity and moisture protection. This product can only function properly and safely if it is correctly transported, stored, installed, set up, operated, and maintained.

This product is intended for use in industrial areas. Operation of this equipment in a residential area may cause interference to several frequency based communications.

Note: Always use product in accordance with specifications.

Copyright Siemens Milltronics Process Instruments Inc. 2010. All Rights Reserved

This document is available in bound version and in electronic version. We encourage users to purchase authorized bound manuals, or to view electronic versions as designed and authored by Siemens Milltronics Process Instruments Inc. Siemens Milltronics Process Instruments Inc. will not be responsible for the contents of partial or whole reproductions of either bound or electronic versions.

Disclaimer of Liability

While we have verified the contents of this manual for agreement with the instrumentation described, variations remain possible. Thus we cannot guarantee full agreement. The contents of this manual are regularly reviewed and corrections are included in subsequent editions. Please check the website shown below for the latest manual revisions. We welcome all suggestions for improvement.

Technical data subject to change.

MILLTRONICS® is a registered trademark of Siemens Milltronics Process Instruments Inc.

Contact SMPI Technical Publications at the following address:

Technical Publications
Siemens Milltronics Process Instruments Inc.
1954 Technology Drive, P.O. Box 4225
Peterborough, Ontario, Canada, K9J 7B1
Email: techpubs.smpi@siemens.com

European Authorized Representative

Siemens AG
Industry Sector
76181 Karlsruhe
Deutschland

- For a selection of Siemens Milltronics level measurement manuals, go to: **www.siemens.com/level**. Choose **Instructions and Manuals** under the More Info list.
- For a selection of Siemens Milltronics weighing manuals, go to: **www.siemens.com/weighing**. Choose **Support**, and then **Manuals / Operating Instructions**.

Introduction

Notes:

- This product is intended for use in industrial areas. Operation of this equipment in a residential area may cause interference to several frequency based communications.
- The Probe is to be used only in the manner outlined in this instruction manual.

The Probe is an ultrasonic level monitor combining sensor and electronics in a single package. It is designed to measure liquid levels in closed vessels. The sensor is PVDF or ETFE, allowing The Probe to be used in a wide variety of industries. The optional sanitary version affords quick removal and ease of cleaning as demanded by the food, beverage and pharmaceutical industries.

The sensor houses the ultrasonic transducer and temperature sensing element. The Probe emits a series of ultrasonic pulses from the transducer. Each pulse is reflected as an echo from the material and sensed by the transducer. The echo is processed by The Probe using Milltronic's proven 'Sonic Intelligence' techniques. Filtering is applied to help discriminate between the true echo from the material, and false echoes from acoustical and electrical noises and agitator blades in motion. The time for the pulse to travel to the material and back is temperature compensated and then converted into distance for display, mA output and relay actuation.

Installation

Environmental

The Probe should be mounted in an area that is within the temperature range specified and that is suitable to the housing rating and materials of construction. The front lid should be accessible to allow programming, wiring and display viewing.

It is advisable to keep The Probe away from high voltage or current runs, contactors and SCR control drives.

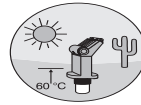
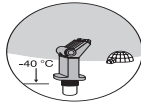

Location

Locate The Probe so that it will have a clear sound path perpendicular to the liquid surface

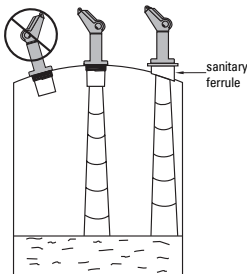

The Probe's sound path should not intersect the fill path rough walls, seams, rungs, etc

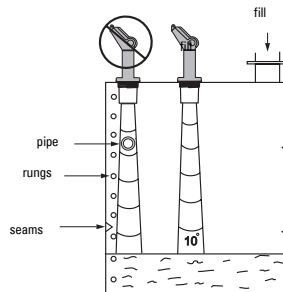

Mounting

Note: Mount The Probe so that the face of the sensor is at least 25 cm above the highest anticipated level.

Threaded

The Probe is available in three thread types:
2" NPT, 2" BSP or PF2.

Note: Before inserting The Probe into its mounting hole, ensure that the threads are of the same type to avoid damaging The Probe threads.

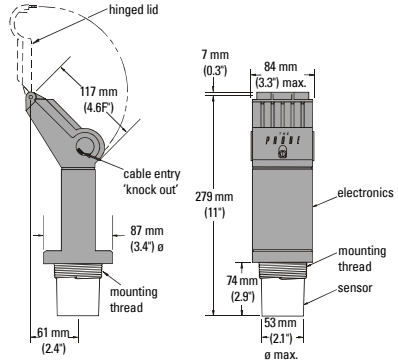

Flange Adapter (optional)

The Probe can be fitted with the optional 75 mm (3") flange adapter for mating to 3" ANSI, DIN 65PN10 and JIS 10K3B flanges.

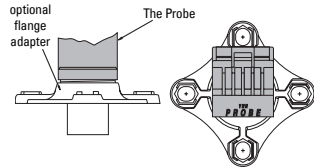

Sanitary

- Notes:**
- Mount The Probe so that the face of the sensor is at least 25 cm above the highest anticipated level.
 - The sanitary Probe is suitable for chemical clean-in-place applications to 60 °C (140 °F) only. Ensure your cleaning chemicals are compatible with PVDF.

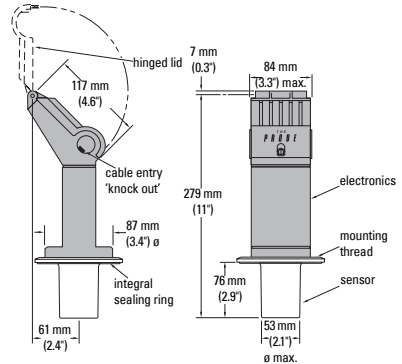

- mount The Probe onto the top of the tank's sanitary ferrule
- secure mating by surrounding the joint with the clamp
- tighten adjusting wing nut

Note: Inside of sanitary ferrule must be smooth, free of burrs, seams or ridges.

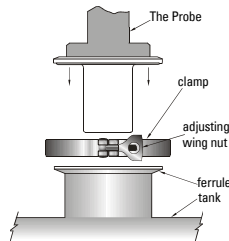

4" Sanitary Ferrule

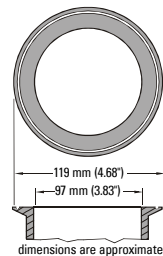

Interconnection

- Notes:**
- Installation shall only be performed by qualified personnel and in accordance with local governing regulations.
 - Separate cables and conduits may be required to conform to standard instrumentation wiring practices, or electrical codes.

- With lid closed, remove cable entry 'knock out' on either side as required.
- Open lid by loosening the lid screw.
- Run cable to The Probe.
- Connect mA output, power supply and relay wiring
- Close lid. Tighten screw to 1.1 to 1.7 N-m (10 to 15 in-lb)

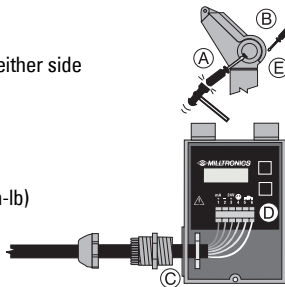

Note: Non-metallic enclosure does not provide grounding between conduit connections. The use of approved watertight conduit hubs/glands is required for Type 4X / NEMA 4X / IP65 (outdoor) applications.

- All field wiring must have insulation suitable for at least 250 V.
- dc terminals shall be supplied from a SELV source in accordance with IEC-1010-1 Annex H.

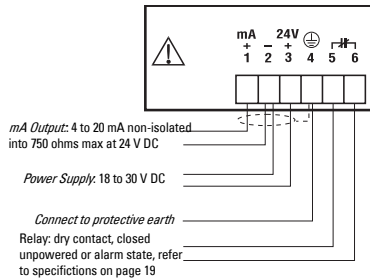

Operation

Start Up

- With The Probe correctly installed (or aimed at a wall 0.25 to 5 m away), apply power.
- The Probe starts up displaying the following:

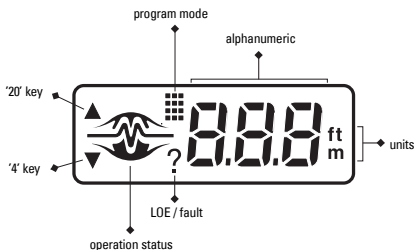

- It then defaults to the Run mode, which is the measurement reading of the distance from the transducer face to the material level in the units indicated:
- If the default display differs from that shown, refer to Operation Status on page 4.



Calibration

The calibration of the mA output may be done such that its span will be either proportional or inversely proportional to the material level.

Note: The 4 and 20 mA levels may be calibrated in any order.

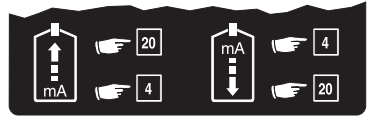



proportional span	inversely proportional span
high level = 20 mA	high level = 4 mA
low level = 4 mA	low level = 20 mA

Calibration: Reference Method

- Adjust the material level (or target) to the desired distance from the sensor face.
- Press the "4" or "20" key (as appropriate) to view the stored distance associated with that mA output value.
- Press the key a second time to set the new distance reference.
- After viewing or calibrating, Probe operation automatically reverts to the Run mode (6 sec). The calibration value is referenced from the face of The Probe sensor, in the units displayed.

4 mA calibration

Press "4" 

Press "4" again  4 mA calibration

 new 4 mA calibration

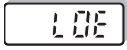
calibration invalid if 
retry

20 mA calibration

Press "20" 

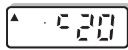
Press "20" again  20 mA calibration

 new 20 mA calibration

calibration invalid if 
retry

Note: Calibration bypasses the measurement response rate.

Operation Status

The graphic portion of the display gives the user a visual indication of The Probe's operating status. Viewing the graphic can assist the user in properly locating and installing The Probe to achieve optimum performance.

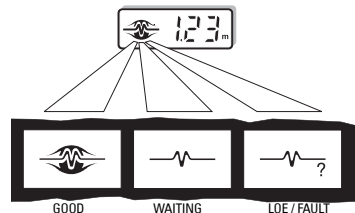

The logo will change from full to partial to indicate operation status. After the 'Waiting' period, the '?' icon will appear for an 'LOE / FAULT' indication. When a valid echo is again received, a 'Good' indication will resume. Refer to Troubleshooting on page 9.

Adjustments

There are several operating adjustments that can be made to The Probe.

- Press the "4" and "20" keys simultaneously until the desired adjustment is obtained. A viewing sequence of the stored value is automatically initiated.
- During this time, press either the "4" or "20" key to change the value. After viewing or changing, operation automatically reverts to the Run mode (6 sec).



4 mA calibration, scrolling



alarm



20 mA calibration, scrolling



fail-safe



blanking



fail-safe timer



speed of response



units

Calibration, Scrolling Method

The 4 and 20 mA calibration values can be selected where reference levels, either from the material in the vessel or from a target, cannot be provided. This method can also be used to trim the output levels obtained by the Reference Method (see page 4).

- To change the stored calibration value, obtain the 'c 4' or 'c 20' display.
- Press the "20" key to increase or the "4" key to decrease the calibration value.
- After scrolling to the desired value, stop pressing the key. The display automatically reverts to the Run mode (6 sec).

4 mA calibration



4 mA calibration initiated



view stored 4 mA calibration value i.e. 4.50 m



press "20" to increase to new calibration value i.e. 4.60 m



new calibration value

20 mA calibration



20 mA calibration initiated



view stored 20 mA calibration value
i.e. 0.50 m



press "4" to decrease to new calibration
value i.e. 0.45 m



new calibration value

Note: For faster scrolling, hold the key depressed during the calibration adjustment and release when desired value is obtained.

Blanking

Blanking is used to ignore the zone in front of the transducer where false echoes are at a level that interfere with the processing of the true echo. It is measured outward from the sensor face. The minimum recommended blanking value is 0.25 m (0.82 ft) but can be increased in order to extend the blanking.

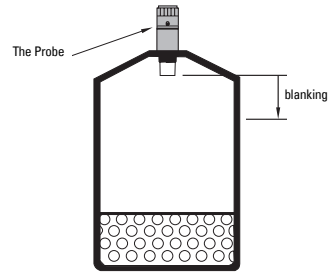

- To change the stored blanking value, obtain the 'bL' display.
- Press the "20" key to increase or the "4" key to decrease the blanking value.
- When the display has scrolled to the desired value, stop pressing the key. The display automatically returns to the Run mode (6 sec).



3 sec blanking



stored blanking value i.e. 0.25 m



press "20" to increase blanking i.e. 0.36 m



press "4" to decrease to desired blanking value i.e. 0.35 m



6 sec new blanking value

Note: For faster scrolling, hold the key depressed during the blanking adjustment and release when desired value is obtained.

Speed of Response

The speed of response adjustment allows the user to collectively set a number of operating parameters.

measurement response:	is the limit to which The Probe will be able to keep up with rates of change. If The Probe measurement cannot keep up with the rate of level change, set the adjustment from '1' to '2'. If The Probe still cannot keep up with the rate of level change, set the adjustment option to '3'. Avoid choosing an option that is too fast for your application.
agitator discrimination:	discriminates between agitator blades in motion, and the material (target) surface.
filter:	discriminates between false echoes from acoustical and electrical noise and the material (target) surface.
fail-safe timer:	establishes the 'Waiting' period from the time a loss of echo or operating fault condition starts until the fail-safe default is effected. Adjusting the speed of response will set the fail-safe timer to the default values in the chart. If a different response is required, adjust the 'FST' option (see page 13).

SP	measurement response	agitator discrimination	filter	fail-safe timer
1*	1 m/min (3.3 ft/min)	on	on	10 min
2	5 m/min (16.4 ft/min)	on	on	3 min
3	immediate	off	off	3 min
4	0.03 m/min (0.1 ft/min)	on	on	10 min

* = factory setting

- To change the speed of response, obtain the `SP' display.
- Scroll forward through the options (1-2-3) by pressing the "20" key. Scroll backward through the options (3-2-1) by pressing the "4" key.
- When the desired option is displayed, stop pressing the key. The display will automatically return to the Run mode (6 sec).

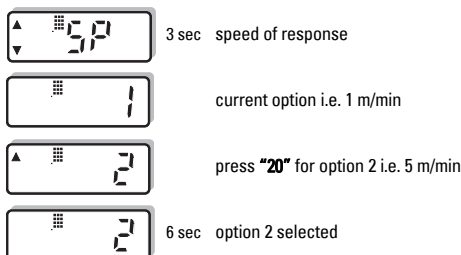

Alarm

The alarm adjustment assigns one of the following functions to the relay.

- 0 = loss of echo / fault alarm (factory setting)
The relay is energized with the contacts open during normal operation (see Fail-safe on page).
- Ø = process alarm
The non zero value entered becomes the alarm setpoint, referenced to The Probe's sensor face. The relay de-energizes and the contacts close when the material is within the alarm zone. There is a hysteresis equivalent to 5% of the empty calibration distance.

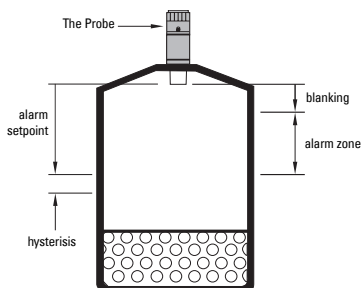

- To change the alarm function or setpoint, obtain the `AL' display.
- Press the "20" key to increase or the "4" key to decrease the setpoint.
- When the display has scrolled to the desired value, stop pressing the key. The display automatically returns to the Run mode (6 sec).

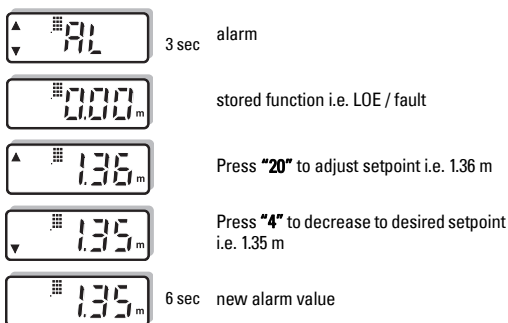

Note: For faster scrolling, hold the key depressed during the setpoint adjustment and release when the desired value is obtained.

Fail-Safe

In the event a loss of echo or fault condition exceeds the `Waiting' period (see Speed of Response on page 6 or Fail-safe Timer below), the `?' icon appears and one of the following fail-safe defaults is immediately effected.

FLS	default	mA ^p	mA ⁱ	reading
1	full	22	4	hold
2	empty	4	22	hold
3*	hold	hold	hold	hold

p = proportional span

i = inversely proportional span

* = factory default

- To change the fail-safe default obtain the `FLS` display.
- Scroll forward through the options (1-2-3) by pressing the **"20"** key. Scroll backward through the options (3-2-1) by pressing the **"4"** key.
- When the desired option is displayed, stop pressing the key. The display will automatically return to the Run mode (6 sec).



3 sec fail-safe



current option i.e. full

Press **"20"** for option 2 i.e. empty

6 sec option 2 selected

Fail-Safe Timer

The fail-safe timer allows the user to vary the 'waiting' period from the time a loss of echo or operating fault condition begins, until the fail-safe default is effected. The 'waiting' period is adjustable from 1 to 15 minutes, in 1 minute increments.

The fail-safe timer value will default to settings determined by the speed of response (see page 11). If a different value is desired, the fail-safe timer should be adjusted *after* the speed of response is set.

- To change the fail-safe timer, obtain the `FSt` display.
- Increase the 'waiting' period by pressing the **"20"** key, and decrease it by pressing the **"4"** key, stopping when the desired value is displayed.
- The display automatically reverts to the Run mode (6 sec).

Units

The units of the measurement reading can be selected as follows:

1 = metres, m (factory setting)

2 = feet, ft

The selected units are also applicable to the `Blanking` and `Alarm` adjustments.

- To change the units obtain the `Un` display.
- Scroll forward through the options (1 - 2) by pressing the **"20"** key. Scroll backward through the options (2 - 1) by pressing the **"4"** key.
- When the desired option is displayed, stop pressing the key. The display will automatically return to the Run mode (6 sec).



3 sec units



current option i.e. m

Press **"20"** for option 2 i.e. ft

6 sec option 2 selected

Loading vs. Supply Voltage

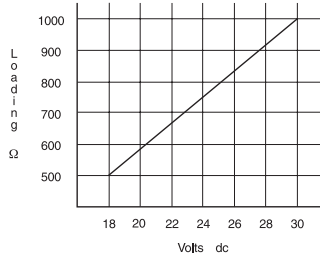

Troubleshooting



The echo is not reliable and The Probe is waiting for a valid echo before updating the measurement.

Probable causes are:

- material or object in contact with sensor face
- The Probe is too close to the fill point
- The Probe is not perpendicular to the liquid surface
- change in level too fast
- measurement out of range
- foam on liquid surface
- high level of vibration in the mounting structure
- level inside the blanking zone



The 'Waiting' period has expired. Investigate the probable causes listed above.

Refer to Speed of Response on page or Fail-safe Timer on page 13 for duration of 'Waiting' periods.

Maintenance

The Probe requires no maintenance or cleaning.

Patents

Instrument Housing Design:

- Canada: 70345
- U.S.A.: 07/858/707
- Germany: M92022723
- U.K.: 2021748
- France: 921873
- Japan: 966217

Electronics / Sensor:

- U.S.A.: 5,267,219
5,339,292
- U.K.: 2,260,059
- patent applications in U.K., Canada, Europe, Africa, Australia

Specifications

Power:

- 18 to 30 V DC, 0.2 A max

Environmental:

- location: indoor / outdoor
- altitude: 2000 m max.
- ambient temperature: continuous: -40 to +60 °C (-40 to +140 °F)
-20 °C (-5 °F) if metal mounting
- relative humidity: suitable for outdoor (Type 4X / NEMA 4X / IP65 enclosure)
- installation category: II
- pollution degree: 4
- process pressure: vented to atmosphere

Range:

- 0.25 to 5 m (0.8 to 16.4 ft.), liquids only (standard 24 V model, black label)
- 0.25 to 8 m (0.8 to 26.2 ft.) (Extended Range model, green label)

Beam Angle:

- 10° at -3 dB boundary

Memory:

- non-volatile EEPROM, no battery required

Programming:

- 2 tactile keys

Temperature Compensation:

- built-in to compensate over the operating range.

Display:

- liquid crystal
- three 9 mm (0.35") digits for reading of distance between sensor face and material
- multi-segment graphic for operation status

Output

- mA:

range:	4 to 20 mA
span:	proportional or inversely proportional
accuracy:	0.25% of full scale
resolution:	3 mm (0.125")
loading:	750 ohms max at 24 V DC supply
cable:	Belden 8760, shielded, twisted pair, 28 AWG (0.75 mm ²) or equivalent
- Relay: 1 normally closed contact rated at 5 A at 250 V AC non-inductive or 24 V DC fault on power, application or device failure

Construction:

- combined sensor and electronics package
- sensor housing: material: PVDF or ETFE
mounting:
 - threaded: 2" NPT, 2" BSP PF2
 - flanged: flange adapter, threaded Probe to 3" ANSI, DIN 65PN10 and JIS 10K3B
 - sanitary: 4" sanitary ferrule with integral sealing ring c/w 304 stainless steel clamp (5 m model only)
- electronics housing: material: PVC
access: hinged lid
 - 22 mm (0.87") dia. 'knock out' for conduit entrance, 2 places
 - 6 screw terminal block for 2.5 mm² (14 ga) solid wire / 1.5 mm² (16 ga) stranded wire max

Enclosure Rating:

- Type 4X / NEMA 4X / IP65

Weight:

- 1.7 Kg (3.7 lb)

Approvals:

- CE*, C-TICK, FM, CSA_{US/C}
 - * EMC performance available on request.

For more information

www.siemens.com/level

www.siemens.com/continuous-weighing

Siemens Milltronics Process Instruments Inc.
Industry Automation (IA)
1954 Technology Drive
P.O. Box 4225
Peterborough, ON
Canada K9J 7B1

email: techpubs.smpi@siemens.com

www.siemens.com/processautomation

Subject to change without prior notice
7ML19985GD62 Rev. 2.0

© Siemens Milltronics Process Instruments Inc. 2010



7 M L 1 9 9 8 5 G D 6 2
Printed in Canada