

Solenoid Valves

Principles of Operation

A solenoid valve is a combination of two basic functional units:

- A solenoid (electromagnet) with its core
- A valve body containing one or more orifices

Flow through an orifice is shut off or allowed by the movement of the core when the solenoid is energized or de-energized. ASCO valves have a solenoid mounted directly on the valve body. The core is enclosed in a sealed tube, providing a compact, leaktight assembly.

Direct Acting Valves (Figures 1A, 1B)

When the solenoid is energized in a direct acting valve, the core directly opens the orifice of a Normally Closed valve or closes the orifice of a Normally Open valve. When de-energized, a spring returns the valve to its original position. The valve will operate at pressures from 0 psi to its rated maximum.

The force needed to open the valve is proportional to the orifice size and fluid pressure. As the orifice size increases, so does the force required. To open large orifices while keeping solenoid size small, a Pilot Operated construction is used.

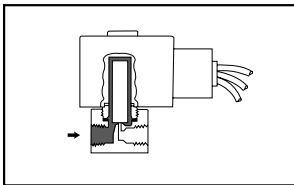

Figure 1A:
Direct Acting,
Normally Closed Valve,
De-Energized

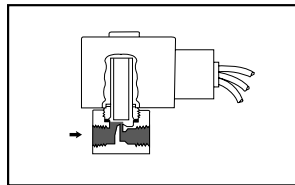

Figure 1B:
Direct Acting,
Normally Closed Valve,
Energized

Internal Pilot Operated Valves (Figures 2A, 2B)

Normally, these valves have a pilot and bleed orifice which enable them to use line pressure for operation.

When the solenoid is de-energized, the pilot orifice is closed and full line pressure is applied to the top of the piston or diaphragm through the bleed orifice, providing seating force for tight closure.

When the solenoid is energized, the core opens the pilot orifice, relieving pressure from the top of the piston or diaphragm via the outlet side of the valve. The line pressure then opens the valve by lifting the diaphragm or piston off the main orifice.

Two constructions are available for 2-way valves:

- Floating diaphragm or piston which requires a minimum pressure drop across the valve to remain in the open position (Figures 2A, 2B).
- Hung-type diaphragm or piston held open mechanically by the solenoid core. The valve opens and remains open with zero pressure drop (Figures 3A, 3B).

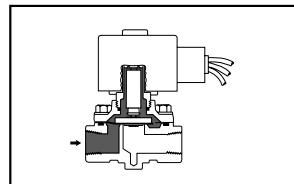

Figure 2A:
Pilot Operated, Normally
Closed Valve,
De-Energized

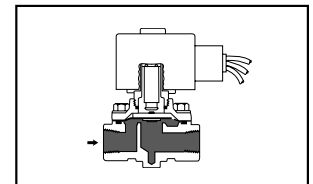

Figure 2B:
Pilot Operated,
Normally Closed Valve,
Energized

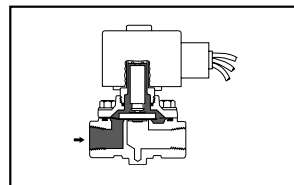

Figure 3A:
Pilot Operated, Normally
Closed Valve,
De-Energized

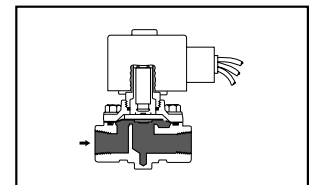

Figure 3B:
Pilot Operated,
Normally Closed Valve,
Energized

Manual Reset Valves (Figures 4A, 4B)

Manual reset valves must be manually latched into position and will return to their original position only when the solenoid has been energized or de-energized, depending on construction

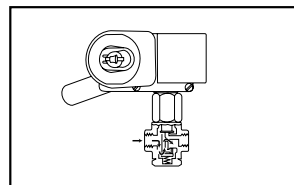

Figure 4A:
No Voltage Release
Manual Reset Valve,
Un-Latched, De-Energized

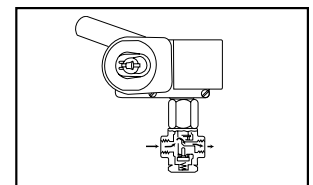

Figure 4B:
No Voltage Release
Manual Reset Valve,
Latched, Energized

Types of Solenoid Valves

2-Way Valves (Figures 1A, 1B, 2A, 2B, 3A, 3B)

Two-way valves have one inlet and one outlet pipe connection. They are used to allow or shut off fluid flow, and are available in either:

Normally Closed – closed when de-energized and open when energized.

Normally Open – open when de-energized and closed when energized.

3-Way Valves (Figures 5A, 5B)

Three-way valves have three pipe connections and two orifices (when one is open, the other is closed, and vice versa). They are commonly used to alternately apply pressure to and exhaust pressure from the diaphragm operator of a control valve, single-acting cylinder, or rotary actuator.

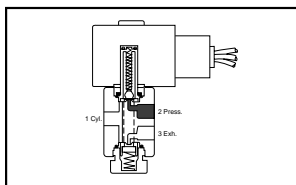

Figure 5A:
Three-Way
Normally Closed Valve,
De-Energized

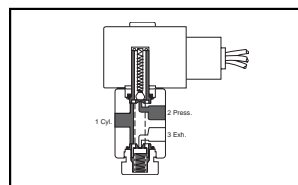

Figure 5B:
Three-Way
Normally Closed Valve,
Energized

Three modes of operation are available:

Normally Closed – when the valve is de-energized, the pressure port is closed and the cylinder port is connected to the exhaust port. When the valve is energized, the pressure port is connected to the cylinder port and the exhaust port is closed.

Normally Open – when the valve is de-energized, the pressure port is connected to the cylinder port and the exhaust port is closed. When the valve is energized, the pressure port is closed and the cylinder port is connected to the exhaust port.

Universal – allows the valve to be connected in either the Normally Closed or Normally Open position to select one of two fluids or to divert flow from one port to another.

4-Way Valves (Figures 6A, 6B)

Four-way valves are generally used to operate double-acting cylinders or actuators. They have four or five pipe connections: one pressure, two cylinder, and one or two exhausts. In Position A, pressure is connected to one cylinder port, the other is connected to exhaust. In Position B, pressure and exhaust are reversed at the cylinder ports.

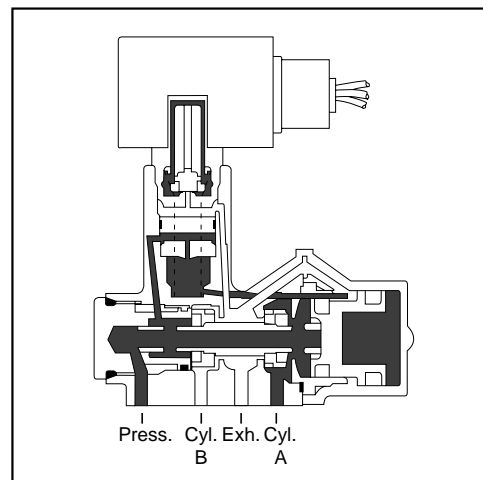

Figure 6A:
Four-Way Valve, De-Energized

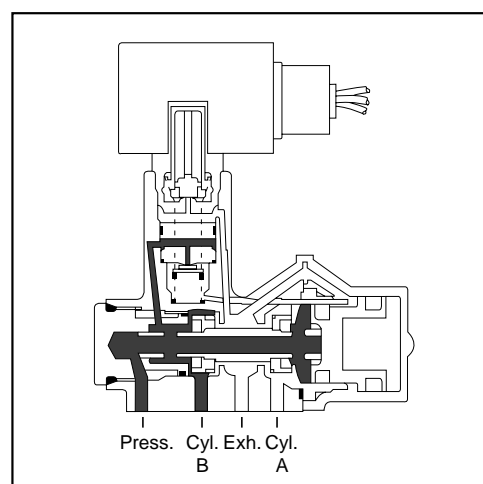

Figure 6B:
Four-Way Valve, Energized

Solenoid

Solenoid Coils (Non-Electronic*)

Except where noted, all ASCO valves are equipped with coils which can be energized continuously without danger of overheating or failure. Standard coils have 18" leads which can be connected to any controlling device. Spade, screw terminal, and DIN-type spade connector coils are also available. For three phase power systems, the two leads can be connected to any two of the three phases.

All coils are constructed in accordance with Underwriters Laboratories Inc., NEMA, IEEE, and other industrial standards ASCO Class B, F, and H insulation systems are UL listed in the Recognized Component Index (yellow book) under Guide No. OBY2.

For AC ambient capabilities, see chart to the right. DC ambient capabilities are 104°F (40°C), or 131°F (55°C) for RedHat II depending on construction. These ambients are based on a minimum available voltage of 85% of nominal. If minimum available voltage is greater, a higher ambient limitation may be possible. *Consult factory for details.*

* See Pages 469-472 for RedHat Next Generation Electronic coils.

Coil Insulation Systems and Temperature Limitations

RedHat II Solenoid Class F 311°F (155°C) and Class H 356°F (180°C)

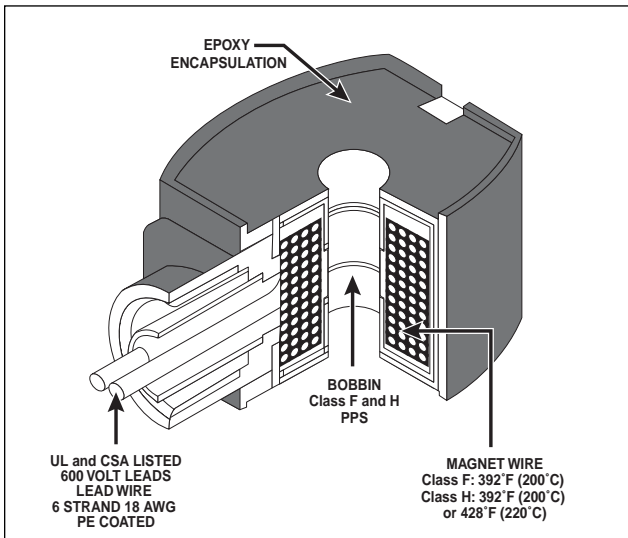

AC Ambient Capabilities

Industrial Temperature Limitations^{① ⑤} and Thermal Characteristics of ASCO RedHat II Solenoids and Coils

The typical watt ratings given show the relationship between different classes of coil insulation and the watt ratings to achieve higher temperature capabilities. The information contained in these tables applies only to Non-Explosionproof, AC constructions.^④

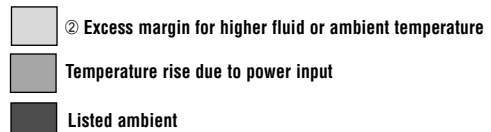

Notes:

- ① As measured by the "Resistance Method."
- ② Ambient temperatures are directly additive to coil rise — fluid temperature is not.
- ③ For M-6, 50 Hz wattage values, add 2 watts to the indicated values.
- ④ Because of explosionproof codes and surface temperature limitations, the maximum listed ambients for specific valves should not be exceeded. *Consult factory concerning explosionproof applications where higher-than-listed ambients are encountered.*
- ⑤ Maximum temperatures shown are industrial limits. For UL limits, subtract 27°F (15°C) for Class F coils and 36°F (20°C) for Class H coils.

Final Temperature °C (°F)

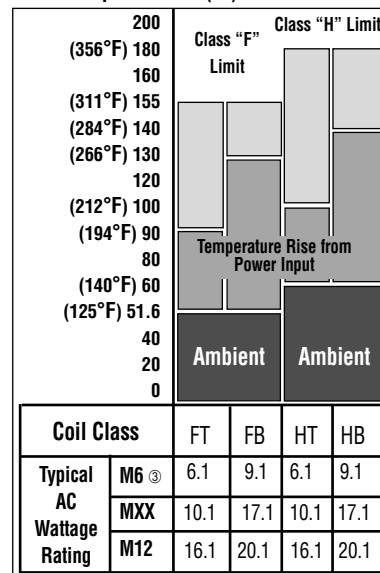

Coil Operating Voltage Ranges

All coils are designed for industrial operating voltages and can be used on the following voltage ranges:

AC		DC	
Nominal Voltage Rating	Normal Operating Range	Nominal Voltage Rating	Normal Operating Range
24	20-24	6	5.1-6.3
120	102-120	12	10.2-12.6
—	—	24	20-25
240	204-240	120	102-126
480	408-480	240	204-252

Note: Special coils are required for battery charging circuits where wider voltage ranges are typically encountered. For these applications, special continuous duty Class H coils are available that will accommodate a voltage range equivalent to 12% over nominal, 28% under nominal, and a 140°F (60°C) ambient. Standard nominal voltages are 125 and 250 DC, which translate to a voltage range of 90-140 and 180-280, respectively. Add prefix "HC" to the catalog number. "HC" prefix is only applicable to valves with coil classes FT and HT. *Consult factory for other constructions.*

Most ASCO valves, depending upon construction, will operate at 15% under nominal voltage and maximum operating pressure differential, and are capable of operating for short periods at 10% over nominal voltage. For coil classes other than FT and HT, over voltage is not recommended. *For wider voltage ranges than shown here or for operating voltage ranges for specific catalog numbers, please consult your local ASCO sales office.*

Power Consumption

Power consumption can be determined from the ratings shown on individual Series pages. For AC valves, the watts, volt-ampere "inrush" (the high momentary surge occurring at coil energization), and volt-ampere "holding" (the continuous draw following inrush) are given.

The current rating for inrush and holding may be determined by dividing the voltage into the volt-amp rating:

$$\text{Inrush Amps} = \frac{\text{volt-amp inrush}}{\text{voltage}}$$

$$\text{Holding Amps} = \frac{\text{volt-amp holding}}{\text{voltage}}$$

DC valves have no inrush current. The amp rating can be determined by dividing the voltage into the DC watt rating:

$$\text{Amps} = \frac{\text{watts (DC)}}{\text{voltage}}$$

Notes:

1. When a valve has been energized for a long period, the solenoid becomes hot and can be touched by hand for only an instant. This is a perfectly safe operating temperature. Any excessive heating will be indicated by smoke and the odor of burning coil insulation.
2. Valves for AC service can be converted to other AC voltages simply by changing the coil. Similarly, DC valves can be converted to other DC voltages. *When converting from AC to DC, or vice versa, consult your local ASCO sales office for instructions.*

Solenoid Constructions

Internal parts in contact with fluids are of non-magnetic 300 and magnetic 400 series stainless steel. In AC constructions, the shading coil is normally copper, except that silver is mostly used in valves with stainless steel bodies. Other materials are available, when required. In DC constructions, no shading coil is required. Typically, the core tubes are of 300 series stainless steel.

Solenoid Enclosures

ASCO offers two types of enclosures, each for a variety of applications: a one-piece molded epoxy construction called the RedHat II solenoid and a conventional RedHat metallic construction. Both meet ICS-6 ANSI/NEMA, and UL Standards 429, 508, and/or 1002. These standards define enclosure protection levels and the tests passed to earn each Type designation. (See Page 469 for RedHat Next Generation Solenoid Enclosures).

RedHat II

RedHat II solenoid enclosures are of one-piece molded epoxy construction, with an integral 1/2" NPT conduit hub. This epoxy encapsulation serves as the enclosure. The magnetic frame is molded into the coil.

RedHat II solenoids are offered as Type 1 General Purpose or Type 7 (A, B, C, and D) Explosionproof.

Type 1 – Solenoids are green and come equipped with three 18" long leads (the green lead is a ground wire). Also available as options are 1/4" spade connectors, screw terminals, and DIN-type terminals meeting ISO 4400 and DIN Standard 43650.

An optional junction box/terminal coil construction is also available for use with spade and screw terminal constructions. Refer to the "Optional Features" Section for details.

Type 7 – Solenoids are black and are available only in the leaded construction.

All RedHat II solenoids also meet the requirements for Types 2 Dripproof, 3 and 3S Raintight, and 4 and 4X Watertight-Corrosion Resistant.

The Following wattages carry Type 7 and Type 9 approvals as shown; for

Wattage	Type 7 Class I, Div. 1 & 2 Gas Groups	Type 9 Class II, Div. 1 Dust Groups
6.1, 10.1, 17.1	A, B, C, D	E, F, G
16.1, 20.1	A, B, C, D	E, F
10.6, 11.6	A, B, C, D	E, F, G

Enclosure Classifications and Types

Type 1	General Purpose	Intended for indoor use, primarily to provide protection for enclosed parts in locations without unusual service conditions.
Type 2	Dripproof	Intended for indoor use, primarily to provide protection against limited amounts of falling water or dirt.
Type 3	Raintight, Dusttight, and Sleet (Ice) Resistant	Intended for outdoor use, primarily to provide protection against wind-blown dust, rain, and sleet; undamaged by the formation of ice on the enclosure.
Type 3S	Raintight, Dusttight, and Sleet (Ice) Resistant	Intended for outdoor use, primarily to provide protection against wind-blown dust, rain, and sleet; external mechanism remains operable when ice laden.
Type 3R	Rainproof, Sleet (Ice) Resistant	Intended for outdoor use, primarily to provide protection against falling rain and sleet; undamaged by the formation of ice on the enclosure.
Type 4	Watertight and Dusttight	Intended for indoor or outdoor use to provide protection against splashing water, water seepage, falling or hose-directed water, and severe external condensation; undamaged by the formation of ice on the enclosure.
Type 4X	Watertight, Dusttight, and Corrosion Resistant	Same as Type 4, but provides additional protection to resist corrosion.
Type 6	Submersible	Intended for indoor or outdoor use to provide protection against entry of water during submersion at a limited depth. (Tested to 6' for 30 minutes.)
Type 6P	Submersible	Same as Type 6 Enclosure, but provides prolonged submersion protection at a limited depth. (Tested to 6' for 24 hours.)
Type 7 & Type 9	Refer to charts on next page.	

Type 7 (A, B, C, and D)

Explosionproof enclosures are designed to contain an internal explosion, without causing an external hazard, when installed in the following atmospheres or locations:

Class 1
Gasses or Vapors

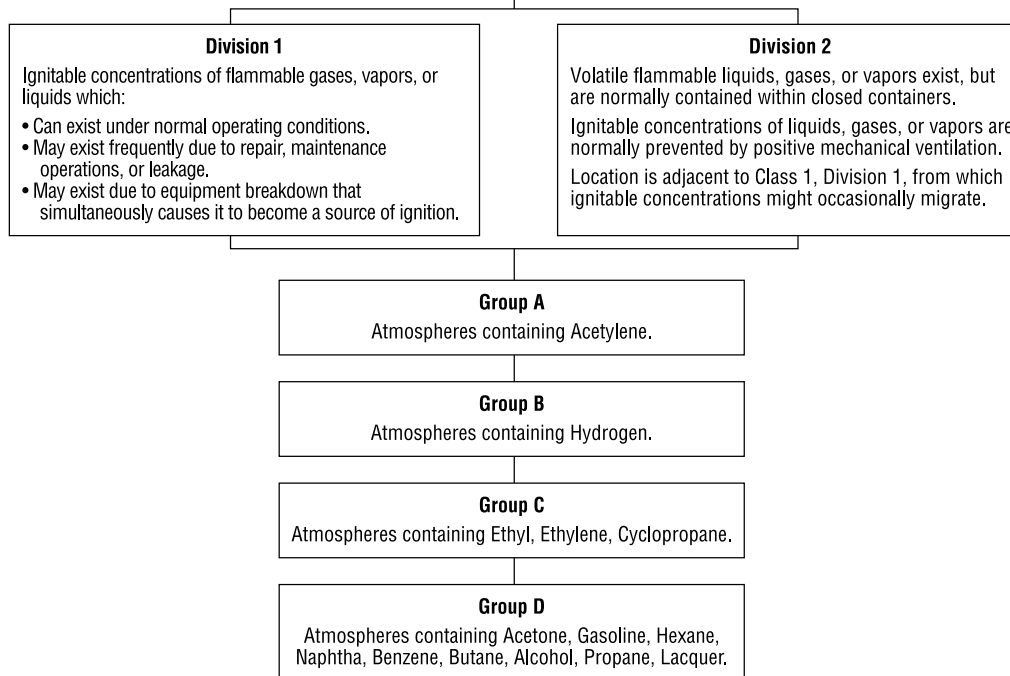

Type 9 (E, F, and G)

Dust-ignitionproof enclosures are designed to prevent the entrance of dust, and the enclosed devices do not produce sufficient heat to cause external surface temperatures capable of igniting dust on the enclosure or in the surrounding atmosphere.

Class II
Dust

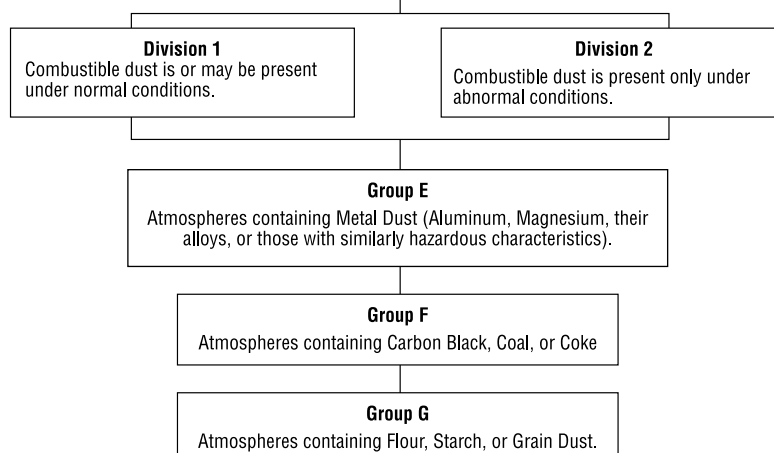

RedHat Metallic Enclosures

Conventional metallic enclosures are offered to meet Type I General Purpose enclosure applications and Type 7 (C and D) Explosionproof enclosure applications.

Type 1 — General Purpose metallic enclosures are epoxy-painted, zinc-coated steel with a 7/8" diameter hole to accept standard conduit hubs or connectors.

Type 7 (C and D) — Explosionproof metallic enclosures are epoxy-painted, zinc-plated steel or die-cast aluminum with a 1/2" threaded conduit hub.

Type 7 enclosures also meet Type 3 (Raintight) requirements as well as some also meet Type 7 (C and D) Explosionproof and Type 9 (E, F, and G) Dust-Ignitionproof requirements for Class I, Division 1, Groups C and D; Class I, Division 2, Groups C and D; and Class II, Division 1, Groups E, F, and G. *Please contact your local ASCO sales office for details.*

Also available as options are: Type 3R (Rainproof), Type 4 and 4X (Watertight), Type 6 (Submersible), Type 7B (Explosionproof for Hydrogen Atmospheres, Class I, Division 1, Group B), as well as Splice Box enclosures. *Please contact your local ASCO sales office for details on these options.*

Note: Metallic solenoid enclosures provide part of the magnetic circuit for the solenoid. Removal will affect valve operation.

Hazardous Location Solenoid Temperature Range Codes

Hazardous location solenoids are marked to indicate the maximum exposed surface temperature or temperature indicating code. This temperature is based on the maximum obtained in the temperature or burnout (blocked core) tests, whichever is higher, at a minimum ambient of 104°F (40°C) or at the rated maximum ambient temperature.

To prevent ignition of hazardous atmospheres, do not install in areas where vapors or gases having ignition temperatures lower than the marked temperatures are present.

The operating temperatures for each indicating code are shown in the following chart:

Operating Temp. Range Indicating Code No.

Maximum Temperature		Code Number
Degrees in C	Degrees in F	
450	842	T1
300	572	T2
280	536	T2A
260	500	T2B
230	446	T2C
215	419	T2D
200	392	T3
180	356	T3A
165	329	T3B
160	320	T3C
135	275	T4
120	248	T4A
100	212	T5
85	185	T6

Note: Except where otherwise noted in specific Series, all RedHat metallic enclosure solenoids have temperature range Code T3C.

Most RedHat II solenoids and/or solenoid valves are marked:

"To prevent fire or explosion, do not install where ignition temperature of hazardous atmosphere is less than 329°F (165°C). Open circuit before disassembly."
This corresponds to code number T3B.

Valves with Class H solenoids and valves used on steam service are marked:

"To prevent fire or explosion, do not install where ignition temperature of hazardous atmosphere is less than 356°F (180°C). Open circuit before disassembly."
This corresponds to code number T3A.

The Class II, Group F, Dust Location designation is not applicable for solenoids and/or solenoid valves used for steam service, or when a Class H solenoid is used.

RedHat II Explosionproof solenoids include an internal, non-resettable thermal fuse to limit solenoid temperature in the event that extraordinary conditions occur which could cause excessive temperatures. These conditions include high input voltage, a jammed valve, excessive ambient temperature, shorted coil, etc. This unique feature is standard only in RedHat II solenoids.

When used on valves having fluid temperature ratings exceeding 250°F (121°C), consult ASCO for applicable enclosure class, groups and temperature range codes. For temperature range codes of optional solenoids and features, or if a better temperature range code is desired, consult your local ASCO sales office.

Operating Pressures

Maximum Operating Pressure Differential (M.O.P.D.)

The maximum operating pressure differential refers to the maximum difference in pressure between the inlet and outlet, against which the solenoid can safely operate the valve. If the pressure at the valve outlet is not known, it is safest to regard supply pressure as the M.O.P.D.

Minimum Operating Pressure Differential

The minimum operating pressure differential is that which is required to open the valve and keep it open. For 2-way valves with a floating piston or diaphragm, the valve will start to close below the minimum operating differential pressure. For 3 and 4-way pilot valves, the minimum operating pressure is measured between the pressure and exhaust ports, and must be maintained throughout the operating cycle to ensure complete transfer from one position to the other.

Note: Direct acting, hung diaphragm or hung piston valves do not require a minimum pressure, but may not yield maximum flow on low pressure differentials.

Safe Working Pressure

Safe working pressure is the line or system pressure to which the valve may be subjected without being damaged. *Contact the factory or your local ASCO sales office if you require this value.*

Proof Pressure

Proof pressure is five times the safe working pressure. *Contact the factory or your local ASCO sales office if you require this value.*

Ambient Temperatures*

Minimum Ambient Temperature

The nominal limitation of 32°F (0°C) is advisable for any valve that might contain moisture (water vapor). Where freezing water is not a factor, minimum ambience as low as 0°F (-18°C) can be tolerated. In addition, special constructions are available for ambient temperatures down to -40°F (-40°C).

Consult your local sales office with your specific needs.

Maximum Ambient Temperature

The nominal maximum ambient temperatures listed are based primarily on test conditions used by Underwriters Laboratories, Inc. for setting safe limits for coil insulation. They are determined under continuously energized conditions and with maximum fluid temperatures in the valves. Actual conditions, in many applications, will permit use at considerably higher ambient temperatures. In addition, modifications to standard constructions are available to extend maximum ambient temperature limitations. *Consult your local ASCO sales office with your specific needs.*

Response Times*

Response time from fully closed to fully open or vice versa depends on the valve size and operating mode, electrical service, fluids, temperature, inlet pressure, and pressure drop. The response time for AC valves on air service, under average conditions, can be generalized as follows:

- Small direct acting valves: 5 to 10 milliseconds.
- Large direct acting valves: 20 to 40 milliseconds.
- Internal pilot operated valves:
 1. Small diaphragm types: 15 to 50 milliseconds.
 2. Large diaphragm types: 50 to 75 milliseconds.
 3. Small piston types: 75 to 100 milliseconds.
 4. Large piston types: 100 to 150 milliseconds

Generally speaking, operation on liquids has relatively little effect on small direct acting valves; however, response time of large direct acting and internally piloted valves will slow by 50% to 100%.

Response time of DC valves will be 50% slower than equivalent AC valves. For specific response time on any critical-timing applications, response time can be reduced to meet specific requirements.

**See Page 469 for RedHat Next Generation Solenoid Valves).*

Air Operated Valves

Principles of Operation

An air operated valve has two basic functional units:

- An operator with a diaphragm or piston assembly which, when pressurized, develops a force to operate
- A valve containing an orifice in which a disc or plug is positioned via air pressure to stop or allow flow

Operators

Two operators are offered in this catalog, each having a pressure range to suit various industrial requirements: instrument air range 3 to 30 psi (0.2 to 2.1 bar) and pneumatic range 30 to 125 psi (2.1 to 8.6 bar).

Control air for the operator is completely isolated from the main line fluid by a unique seal arrangement (see Figure 7). This permits a wide range of main line fluids to be handled.

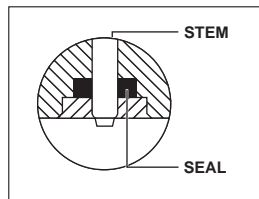

Figure 7

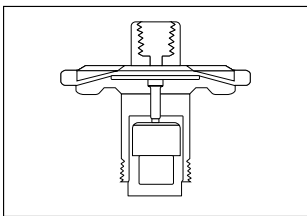

Figure 8A: Instrument Air Pressure Range Operator

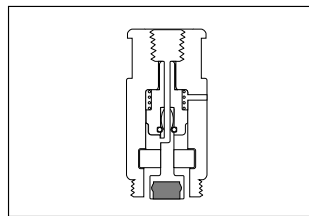

Figure 8B: Pneumatic Range Operator

When a particular valve is selected, any pressure within its pressure range will operate the valve, regardless of variations in the main line pressure.

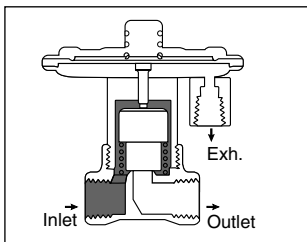

Figure 9A: Normally Closed, Direct Acting, Air Operated Valve with Operator Exhausted

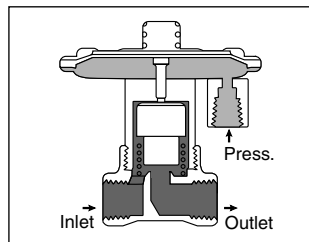

Figure 9B: Normally Closed, Direct Acting, Air Operated Valve with Operator Pressurized

The instrument air pressure range operator utilizes a diaphragm (see Figure 8A) for operation, while the pneumatic range operator has a piston (see Figure 8B). By applying pressure to and exhausting pressure from the operator, the main valve will open or close.

Direct Acting Valves (Figures 9A, 9B)

In a direct acting valve, the operator stem is moved by the diaphragm or piston and directly opens or closes the orifice, depending on whether the operator is pressurized or exhausted. The valve will operate from zero psi to its maximum rated pressure.

Internal Pilot Operated Valves (Figure 10A, 10B)

This valve is equipped with a pilot and bleed orifice and uses the line pressure for operation. When the operator is pressurized, it opens the pilot orifice and releases pressure from the top of the valve piston or diaphragm to the outlet side of the valve. This results in unbalanced pressure, which causes the line pressure to lift the piston or diaphragm off the main orifice, thereby opening the valve. When the operator is exhausted, the pilot orifice is closed and full line pressure is applied to the top of the valve piston or diaphragm through the bleed orifice, providing a seating force for tight closure.

Two types of construction are available:

- Floating diaphragm or piston, which requires a minimum pressure drop to hold it in the open position.
- Hung type diaphragm or piston, which is mechanically held open and operates from zero to the maximum pressure rating.

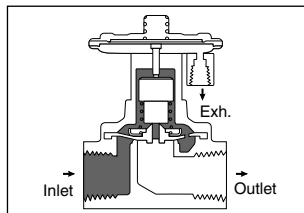

Figure 10A: Normally Closed, Internal, Pilot Operated Valve with Operator Exhausted

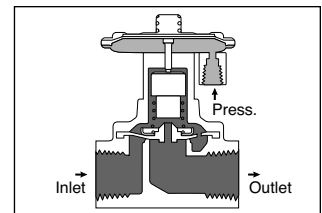

Figure 10B: Normally Closed, Internal, Pilot Operated Valve with Operator Pressurized

Types of Air Operated Valves

2-Way Valves:

Normally closed and normally open operation. Figures 9A, 9B, 10A, 10B, 11A, 11B.

3-Way Valves:

Normally closed, normally open and universal operation. Figures 12A-D, 13A-D.

4-Way Valves:

Figures 14A-D

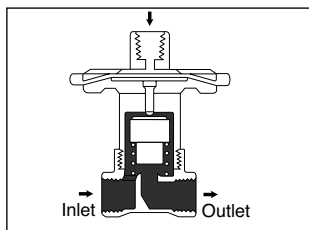

Figure 11A: Normally Open, Operator Exhausted

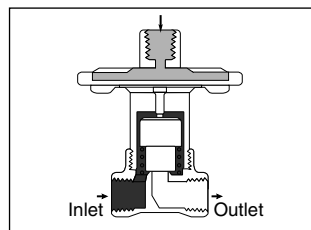

Figure 11B: Normally Open, Operator Pressurized

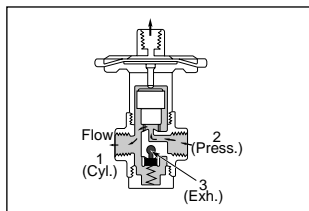

Figure 12A: Normally Open, Operator Exhausted

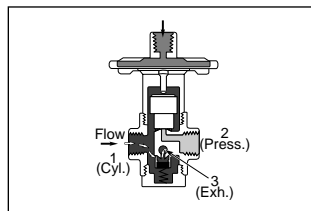

Figure 12B: Normally Open, Operator Pressurized

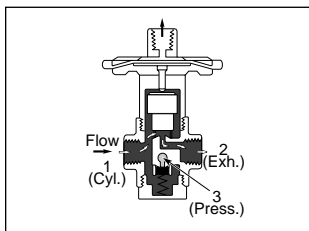

Figure 12C: Normally Closed, Operator Exhausted

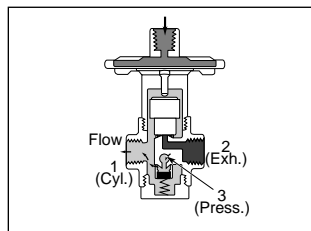

Figure 12D: Normally Closed, Operator Pressurized

Operating Pressures

Minimum Operating Pressure Differential

The minimum operating pressure differential is that which is required to open the valve and to keep it open. Two way valves with floating piston or diaphragm will start to close below the minimum differential pressure. Three and four way pilot valves must maintain the minimum operating pressure throughout the operating cycle to ensure complete transfer from one position to the other.

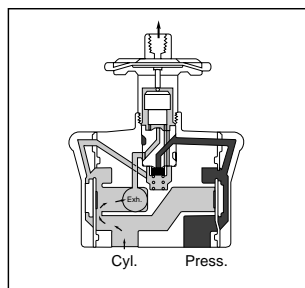

Figure 13A: Normally Closed, Operator Exhausted

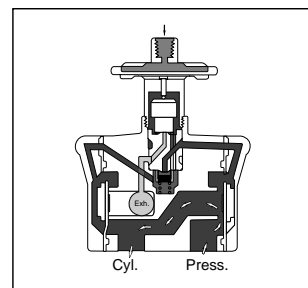

Figure 13B: Normally Closed, Operator Pressurized

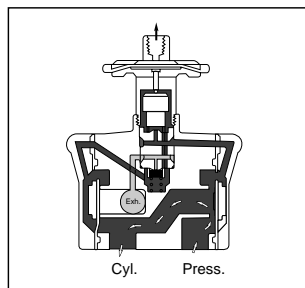

Figure 13C: Normally Open, Operator Exhausted

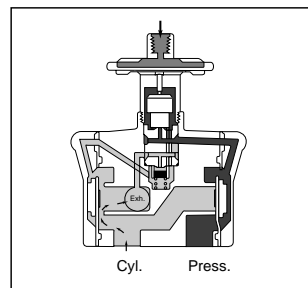

Figure 13D: Normally Open, Operator Pressurized

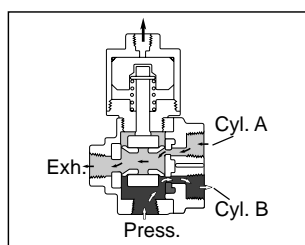

Figure 14A: Operator Exhausted

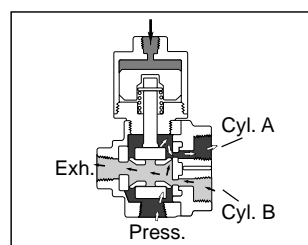

Figure 14B: Operator Pressurized

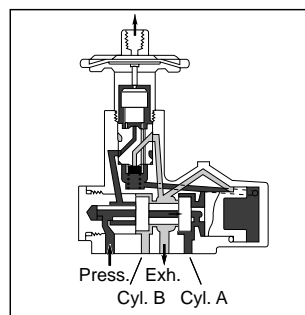

Figure 14C: Operator Exhausted

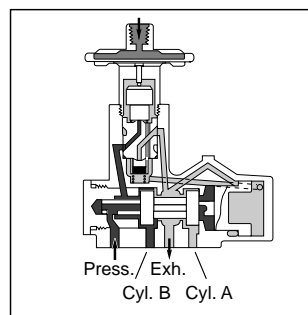

Figure 14D: Operator Pressurized

Maximum Operating Pressure

Maximum operating pressure is the highest pressure at the inlet side of the valve, against which the operator can operate the valve. This pressure may be much less than the maximum safety rating of the valve body.

Note: Direct acting valves do not require a minimum pressure.

Approvals

Approval Listing Code and Information

UL, FM, CSA listings and compliance to applicable CE directives have been indicated for each Series in this catalog. Listing codes and other information follow in this section.

In addition to approvals with the standard features and for the standard voltages listed in each Series, many valves with optional features and other voltages have also been approved. *Consult your local ASCO sales office for details.*

Agency Valve Classifications and Code Reference

General Purpose Valve – a Normally Open or Normally Closed valve intended to control the fluid flow, but not to be depended upon to act as a safety valve. This is a UL and CSA classification, and is not intended to indicate valve service or application.

Safety Shutoff Valve – a Normally Closed valve of the “on” and “off” type, intended to be actuated by a safety control or emergency device, to prevent unsafe fluid delivery. It may also be used as a General Purpose valve. A multiple port valve may be designated as a Safety Shutoff valve only with respect to its Normally Closed port. This is a UL, FM, and CSA valve classification. Safety shutoff valves are listed in UL index under Guide YIOZ or YIOZ2 for ordinary locations and YTSX or YTSX2 for hazardous locations.

Process Control Valve – an FM approved valve to control flammable gases, not to be relied upon as a Safety Shutoff valve. Refer to note under individual valve listing. Unless otherwise stated under the individual Series numbers, valves are listed as General Purpose valves.

Underwriters Laboratories, Inc.

UL standards governing solenoid valves are:
UL429, “Electrically Operated Valves,”



UL1002, “Electrically Operated Valves for Use in Hazardous Locations.”

UL1604, “Electrical Equipment for use in Class I and II, Division 2 and Class III Hazardous Classified Locations.”

UL provides two “Listing” categories for solenoid valves:

General Use. Valves authorized for general use are complete in their requirements; therefore, they may be installed in the field. They are identified by the UL symbol, followed by the word “Listed” and the valve

classification. UL Listings for ASCO “General Use” valves and solenoids can be found in the “UL Gas and Oil Equipment Directory” under Electrically Operated Valves, Guide No. YIOZ or YIOZ2 (File MP-618), and in the “UL Hazardous Location Equipment List” under Electric Valves, Guide No. YTSX or YTSX2 (File E25549) or under Solenoids, Guide No. VAPT (File E12264).

Component. Valves in this category are intended for use as factory-installed components of equipment where final acceptability must be determined by UL. They are not intended for installation in the field.



Component valves are termed “UL Recognized” and use UL’s special Recognized Component mark. UL Listings of ASCO Component Valves can be found in the “UL Recognized Component Index” under Electrically Operated Valves, Guide No. YIOZ2 and YSY12 (File MP-618).

Canadian Standards Association

Standard C22.2 No. 139, “Electrically Operated Valves,” covers the standards governing solenoid valves.



Standard C22.2 No. 213, “Electrical equipment for use in Class I, Division 2 hazardous locations.” CSA certified valves and solenoids are listed in the “CSA Certified Electrical Equipment Book” under Valves, Guide No. 440-A-0 (File 10381) and Guide No. 440-A-0.8 (File 13976).

Factory Mutual Research Corporation

FM “approves” and lists in the “Factory Mutual Approval Guide” fuel oil and fuel gas safety shutoff valves, process control valves, explosionproof/dust-ignitionproof, and intrinsically safe valves for hazardous locations. Valves designated for other fluids and operational characteristics, although not subject to FM approval, are usually “accepted” by FM on specific equipment installations.



Industrial Risk Insurers (Formerly FIA)

Industrial Risk Insurers does not approve equipment. It established "recommended good practices" in such areas as combustion safeguards on single-burner boiler-furnaces, and safeguarding Class B and Class C furnaces and ovens. Conforming to these practices results in either insurability for fire protection or in more advantageous rates for their protection.

To meet the standards of good practice, safety controls must be either listed by Underwriters Laboratories, accepted by Industrial Risk Insurers or other nationally recognized testing laboratories (NRTL). The National Fire Protection Association (NFPA) maintains similar requirements and recommendations for safety shutoff and vent valves in oil and gas burner boiler systems.

European Directives – CE



The Council of the European Communities, under the treaty establishing the European Community (EC), adopted into law a series of directives to harmonize technical standards.

Solenoid valves are controlled by:

EMC (Electromagnetic Capability) 2004/108/EC
Low Voltage 2006/95/EC

ASCO valves complying to these directives, through third-party or self-certification, display the CE mark on the nameplate or coil and on the Instruction and Maintenance sheet packaged with each valve. On request, ASCO will issue a Declaration of Incorporation and/or Declaration of Conformity for the valve supplied.

Agency Approvals – Worldwide

ASCO's Quality Assurance Program meets all the requirements of ISO-9001:2008. We are also certified to IQ Net, providing customers with the products from 17 ISO-certified facilities around the world. The US, Canada, UK, France, the Netherlands, Germany, and Japan are included.

When desired, ASCO solenoid valves can be supplied to meet the additional requirements of a variety of approval agencies around the world. The following can be requested. *Consult your local ASCO sales office for details.*

United States of America

AGA	American Gas Association
ANSI	American National Standards Institute, Inc.
CSA	Canadian Standards Association (Certified to US Standards)
EIA	Electronic Industries Association
ETL	Electronic Testing Laboratory
FM	Factory Mutual Research Corporation
IEEE	Institute of Electrical and Electronics Engineers, Inc.
IRI	Industrial Risk Insurers (formerly Factory Insurance Association)
JIC	Joint Industrial Council
MIL	Military Standards
MSHA	Mine Safety and Health Administration
NACE	National Association of Corrosion Engineers
NAVSEA	Naval Sea Systems Command
NEC	National Electric Code
NEMA	National Electrical Manufacturers Association
NFPA	National Fire Protection Association
NFPA	National Fluid Power Association, Inc.
NSF	National Sanitation Foundation
UL	Underwriters Laboratories, Inc.
USCG	United States Coast Guard

European Economic Community

CE	European Directives
CEE	International Commission on Rules for the Approval of Electrical Equipment
ATEX	Directive 94/9/EC Apparatus for Potentially Explosive Atmospheres (ATmospheres EXplosibles)
IEC	International Electrotechnical Commission
ISO	International Organization for Standardization

Austria

TÜV-A	Technischer Überwachungs-Verein Österreich
BVFA	Bunderversuchs-und Forschungsanstalt Arsenal
ETI	Elektrotechnisches Institut

Australia

AGA	Australian Gas Association
SAA	Standards Association of Australia

Belgium

CEB	Comite Electrotechnique Belge
IBN	Institut Belge de Normalisation
ISSEP	Institut Scientifique de Service Public (anciennement INIEX)
K.V.B.G.	Koninklijke Vereniging der Belgische Gasvakiieden
VERGAS	Technische Vereniging van de Gasindustrie in Belgie V.Z.W.D.

Brazil

INMETRO	Instituto Nacional de Metrologia
---------	----------------------------------

Canada

CGA	Canadian Gas Association
CSA	Canadian Standards Association
EEMAC	Electrical and Electronic Manufacturers Association of Canada
ULC	Underwriters Laboratories of Canada

China

NEPSI	National Supervision and Inspection Center for Explosion Protection and Safety of Instrumentation
CCC	China Compulsory Certification

Denmark

DEMKO	Danmarks Elektriske Materielkontrol
-------	-------------------------------------

Finland

SL	Sähkötarkastuslaitos Laboratoria
VTT	Technical Research Centre of Finland

France

AFNOR	Association Française de Normalisation
INERIS	Institut National de l'Environnement Industriel et des Risques (anciennement CERCHAR)
Bureau Veritas	
LCIE	Laboratoire Central des Industries Electriques
MDIS	Ministère du Développement Industriel et Scientifique

Germany

BVS	Bergbau-Versuchsstrecke
DIN	Deutsches Institut für Normung
DVGW	Deutscher Verein des Gas – Und Wasserfaches e.V.
Germanischer Lloyd	
PTB	Physikalisch – Technische Bundesanstalt
VDE	Verband Deutscher Electrotechniker

Italy

CEI	Comitato Elettrotecnico Italiano
-----	----------------------------------

Japan

JEM	Japan Electrical Manufacturers Association
JIS	Japanese Industrial Standards
MIL	Ministry of Labor
NK	Japan Maritime Association
RIIS	Research Institute of Industrial Safety, Department of Labor

Korea

KISCO	Korea Industrial Safety Corp.
KGSG	Korea Gas Safety Corp.

Luxembourg

Service de l'énergie de l'état	
--------------------------------	--

Northern Ireland

Industrial Science Centre, Department of Economic Development	
---	--

Norway

Det Norske Veritas	
NEMKO	Norges Elektriske Materiekkontroll

Russia

USSR	Register of Shipping
------	----------------------

South Africa

SABS	South African Bureau of Standards
------	-----------------------------------

Spain

CESI	Centro Elettrotecnico Sperimentale Italiano
LOM	Laboratorio Oficial José Maria Madariaga

Sweden

SEMKO	Svenska Elektriska Material Kontrollanstalen
SP	Swedish National Testing and Research Institute

Switzerland

ASE	Association Suisse des Electriciens
SEV	Schweizerischer Electrotechnischer Verein

The Netherlands

DGA	Direktooraat – Generaal van de Arbeid
KEMA	Koninklijk Instituut voor het Testen van Elektrische Materialen N.V.
NEC	Nederlands Elektrotechnisch Comité
NNI	Nederlands Normalisatie – Instituut
REGO	Richtlijnen Voor de Samenstelling van Elektrisch Material In Verband Met Gasontploffingsgevaar
VEG	VEG-Gasstituut N.V.
VGN	Vereniging van Gasfabrikanten In Nederland

United Kingdom

BASEEFA	British Approvals Service for Electrical Equipment in Flammable Atmospheres
BGC	British Gas Corporation
BSI	British Standard Institution
EECS	Electrical Equipment Certification Service (BASEEFA)
Lloyds	Register of Shipping
MRS	Midlands Research Station
NWC	National Water Council
SCS	Sira Certification Service
SFA	Special Flammable Atmospheres
WH	Watson House

Flow Data

Importance of Valve Sizing

Improper sizing of a solenoid valve results in below-standard performance and can involve unnecessary cost.

The basic factors in valve sizing include:

- Maximum and minimum flows to be controlled
- Maximum and minimum pressure differential across the valve
- Specific gravity, temperature, and viscosity of fluids being controlled

The Cv method of valve sizing reduces all variables to a common denominator called the Flow Coefficient. After existing or projected conditions have been converted to this coefficient (the Cv), the proper valve size can be found in the catalog pages.

This section provides the complete procedure and reference data for accurate sizing of ASCO solenoid valves in liquid, gas services, and steam. The graphs provide the simplest means of finding the required Cv factor, and are based on the formula:

$$Cv = \frac{\text{Flow Required}}{\text{Graph Factor}}$$

The graph factor can be determined by aligning known pressure conditions on the graphs.

Estimating Cv or Orifice Size:

The table below can be used to estimate a Cv if the orifice size is known or, conversely, to relate the approximate orifice size if the Cv is known. The chart is based on the ASCO designs of inline globe type valves.

The flow charts must be used for precise sizing and converting Cv factors to actual flow terms, and the catalog must be consulted for the actual Cv of a particular valve.

Approximate Orifice Size (ins.)	Approximate Cv	Approximate Orifice Size (ins.)	Approximate Cv
1/32	.02	1/2	3.5
3/64	.06	5/8	4.5
1/16	.09	11/16	5
3/32	.20	3/4	7.5
1/8	.30	1	13
9/64	.36	1 1/4	17
3/16	.53	1 1/2	25
1/4	.70	2	48
5/16	1.7	2 1/2	60
3/8	2	3	100

Sample Problems

Liquids: ①

To find Cv: What Cv is required to pass 20 GPM of oil, with a specific gravity of 0.9 and a pressure drop of 25 psi? The viscosity is less than 300 SSUs.②

Solution: Formula is:

$$Cv = \frac{GPM}{Fg \times Fsg}$$

To find Fg (Graph Factor), use Liquid Flow Graph on page 11.16. The Fg factor is that corresponding to 25 psi pressure drop and equals 5. The Fsg factor (Specific Gravity Factor) can be obtained from the Fsg Chart, and is that corresponding to .9 specific gravity and equals 1.05.

Therefore:

$$Cv = \frac{20}{5 \times 1.05} = 3.81$$

Air and Gases:

To find Cv: A valve is required to pass 500 SCFH at an inlet pressure of 60 psig and a Δp ③ of 10 psi. Find Cv if the fluid is carbon dioxide at room temperature.

Solution: Refer to 10-100 psig graph on page 11.17. The formula to be used is:

$$Cv = \frac{SCFH}{Fg \times Fsg \times Ft}$$

Locate Fg at the intersection of 60 psig inlet pressure and 10 psi Δp ③ (curved lines). Read down to Fg. Fg=1560.

Locate Fsg corresponding to specific gravity of carbon dioxide (S.G.=1.5). Fsg=0.81. (Refer to next page.) Since the gas is at room temperature, the Ft factor can be ignored.

Insert values into formula:

Steam:

To find Cv: A valve is required to pass 25 lb/hr of saturated steam at an inlet pressure of 7 psig and a Δp ③ of 3 psi. What is the Cv?

Solution: Refer to the Steam Graph on page 11.18.

Use formula:

$$Cv = \frac{lb/hr}{Fg}$$

Locate Fg on graph corresponding to 7 psig inlet pressure and 3 psi Δp ③ (curved lines). Fg = 23.5.

Insert values into formula:

$$Cv = \frac{25}{23.5} = 1.06$$

For further information, consult your local ASCO sales office.

Notes:

- ① Liquid formulas and flow graphs are based on US gallons.
- ② If viscosity is less than 300 SSU, correction factors are not necessary.
- ③ Δp stands for pressure drop.

Fsg Chart

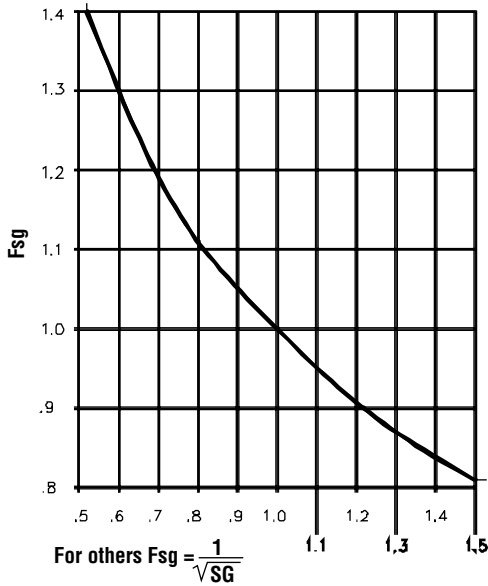

Specific Gravity @ 14.7 PSIA and 60°F.

Ft Chart

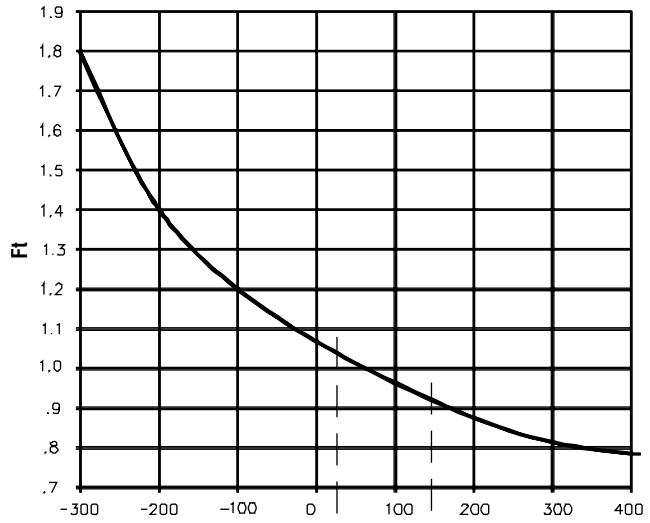

For others $F_t = \sqrt{\frac{530}{(460 + ^\circ F.)}}$

Temperature (°F)

The correction for temperature in the range of 20°F to 150°F is very small and, therefore, can be ignored in ordinary applications.

Liquid Flow Graph

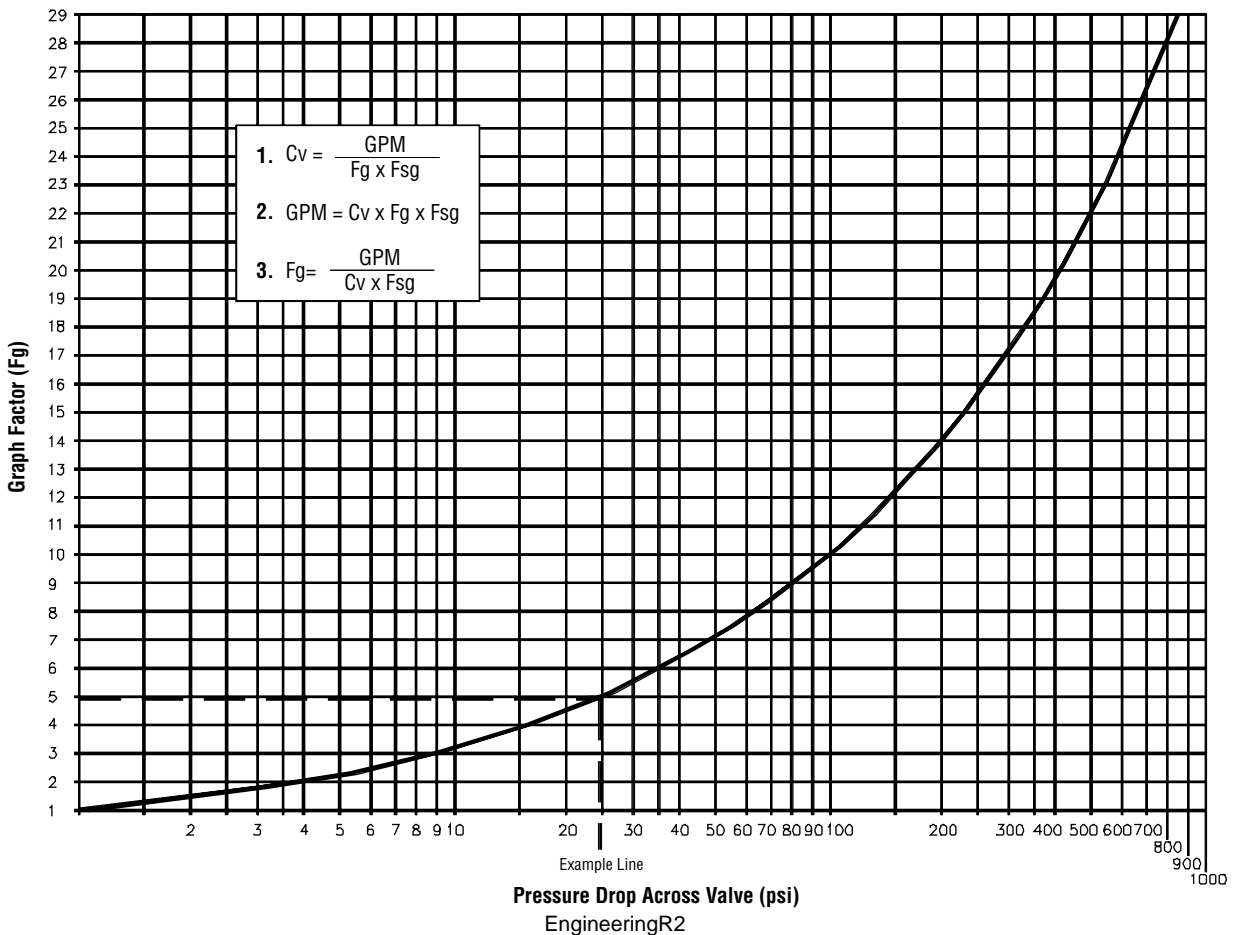

Air and Gas Flow Graphs

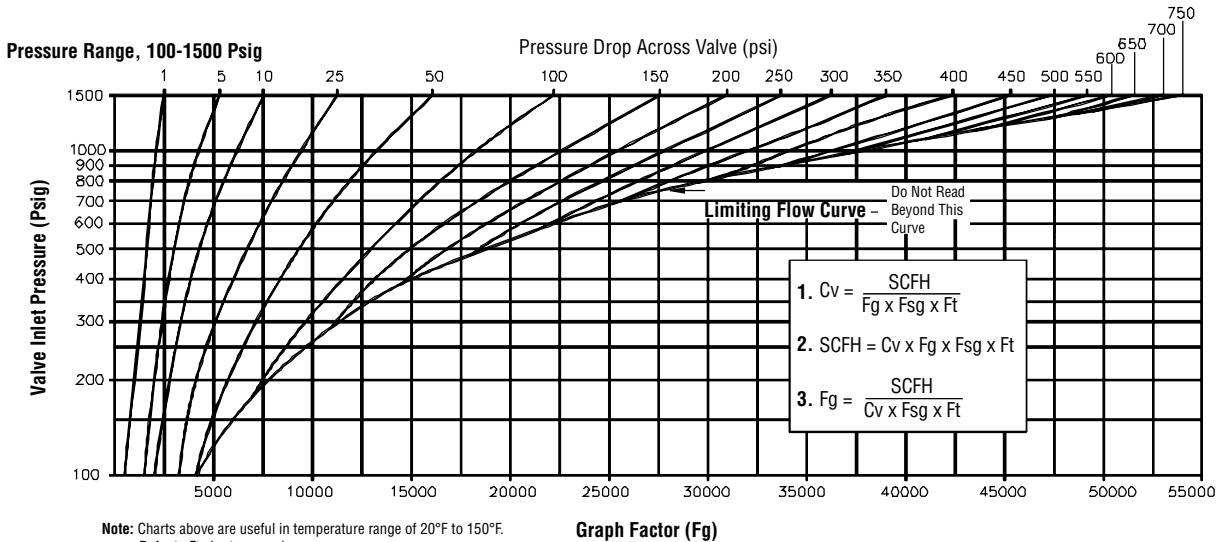
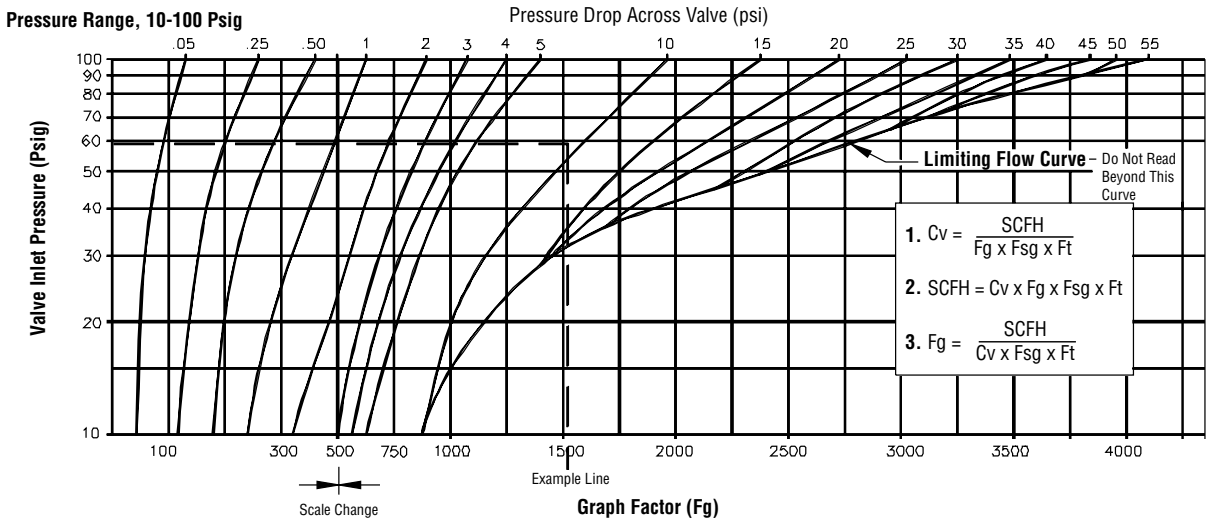
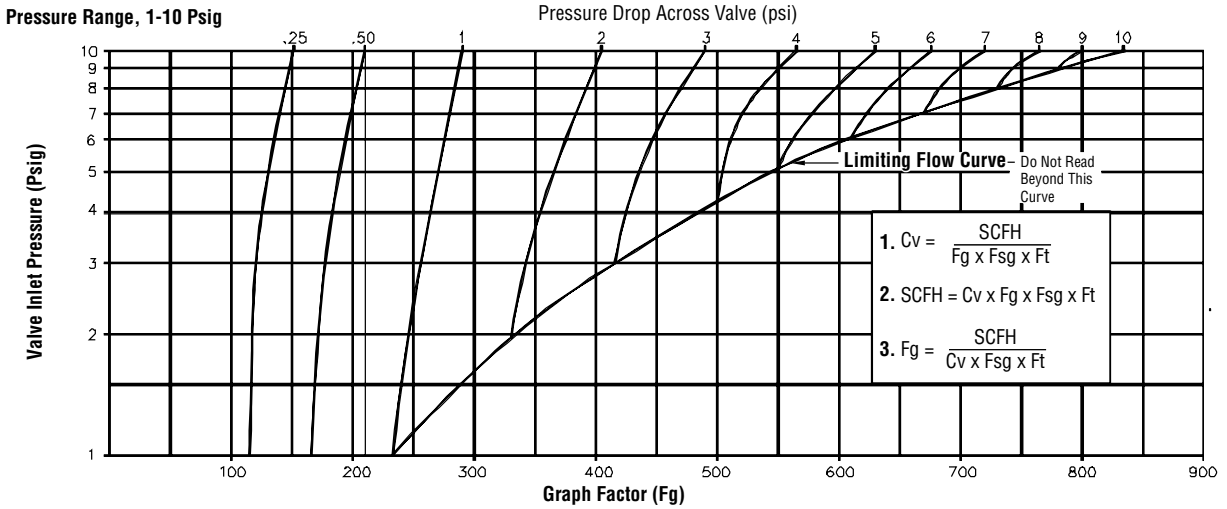

Note: Charts above are useful in temperature range of 20°F to 150°F.
Refer to Ft chart on previous page.

Steam Flow Graphs

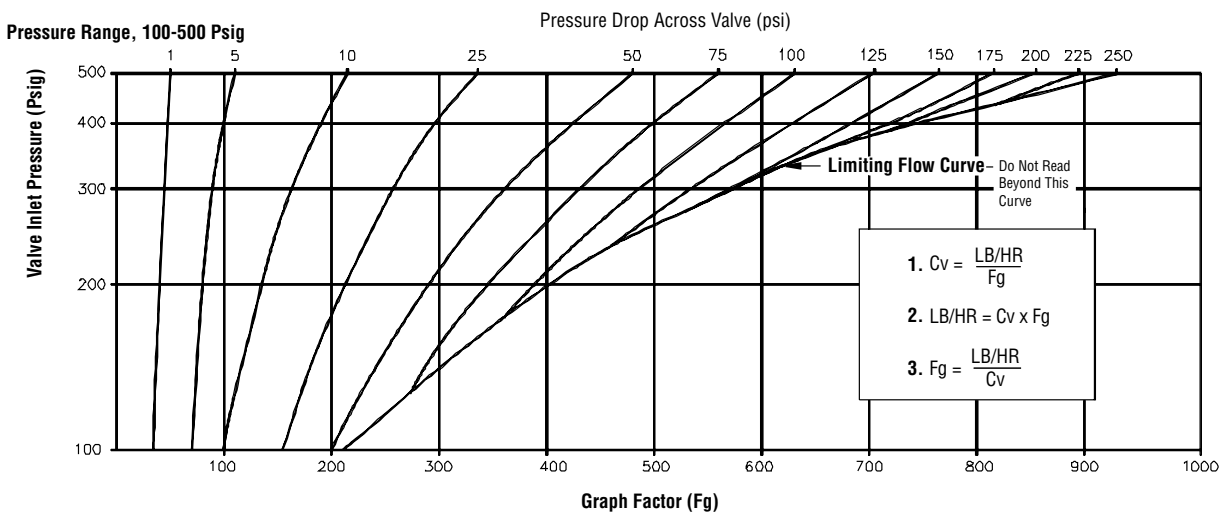
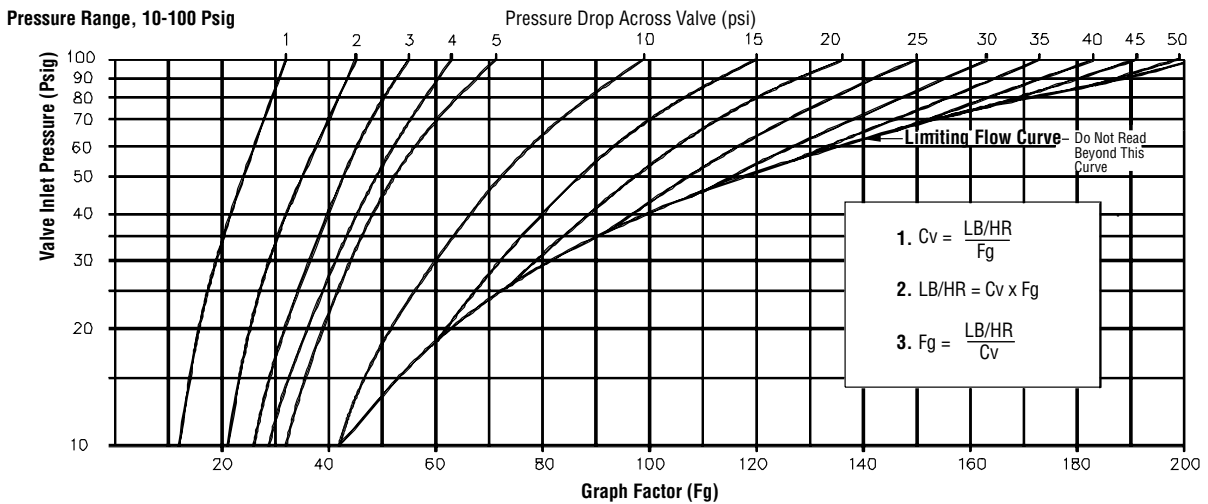
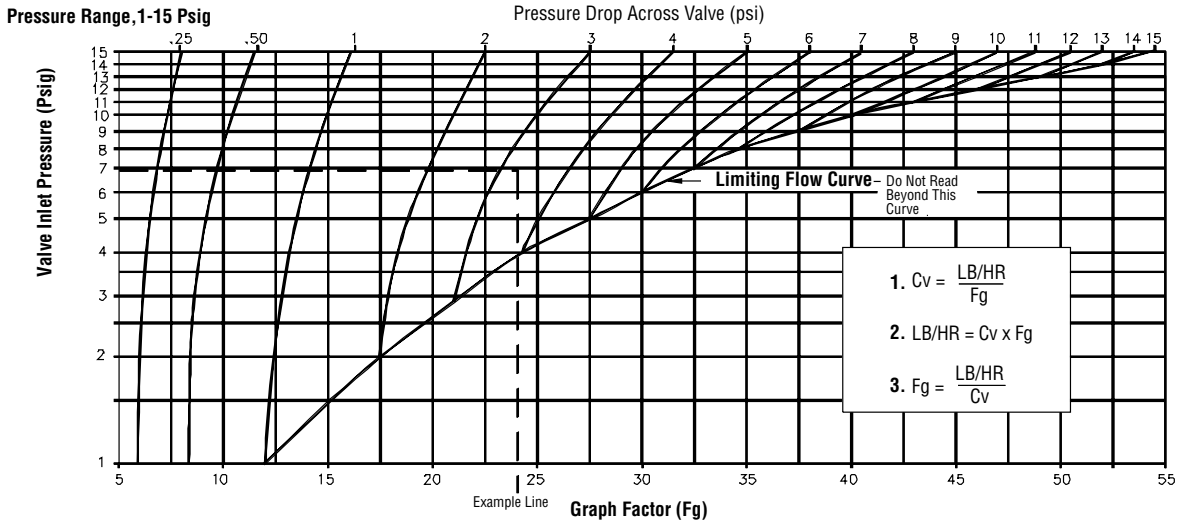

Material Selection Guide for Commonly Used Fluids

All orders entered using this guide must state actual fluid, fluid pressure, fluid concentration, and fluid temperature of the application. Actual fluid is extremely important when elastomer options are specified because other substitutions may be required.

ASCO valves are available to control many acids, alcohols, bases, solvents, and corrosive gases and liquids. Modified or special designs are sometimes required, depending upon the application.

Corrosion occurs either as a chemical or electro-chemical reaction. Therefore, consideration must be given to both the galvanic and electromotive force series, as well as to pressure, temperature, and other factors that might be involved in the application.

This guide provides information on types of valves that are available for most common corrosive and non-corrosive gases and liquids. *For applications in which abnormal conditions exist and for other fluids, consult your local ASCO office, giving full details on operating conditions.*

This guide is not intended as a specific recommendation; factors beyond our control could affect valve operation or materials.

General Information on Elastomer Materials Frequently Used in ASCO Valves

NBR (Buna 'N', Nitrile)

NBR is commonly referred to as a nitrile rubber and is the standard synthetic elastomer for accomplishing resilient-type seating or sealing in ASCO valves. It has excellent compatibility for most air, water, and light oil applications. It has a useful temperature range of 0°F to 180°F (-18°C to 82°C).

CR (Neoprene)

CR is principally used as an external seal in refrigeration applications. It is also utilized for oxygen service. It has a useful temperature range of 0°F to 180°F (-18°C to 82°C).

EPDM (Ethylene Propylene)

EPDM is selected for applications above the NBR temperature range, such as handling hot water and steam. Ethylene propylene has an extremely wide range of fluid compatibility, but has the distinct disadvantage that it cannot be used with petroleum-based fluids or contaminated fluids (such as lubricated air). It has a useful temperature range of -10°F to 300°F (-23°C to 149°C).

FKM (Viton®/Fluorel®, etc.)

FKM is a fluorocarbon elastomer primarily developed for handling such hydrocarbons as jet fuels, gasolines, solvents, etc., which normally cause detrimental swelling to NBR. FKM has a high temperature range similar to EPDM, but with the advantage of being

somewhat more resistant to "dry heat." FKM has a wide range of chemical compatibility. It has a useful temperature range of 0°F to 350°F (-18°C to 177°C).

PTFE (Teflon®, Rulon)

PTFE and PTFE with fillers are considered more a plastic than a resilient-type material. They are virtually unattacked by any fluid. Their temperature usage has ranged from discs for cryogenic valves to discs for steam valves. They are not easily fabricated and are known to have "cold flow" characteristics which may contribute to objectionable leakage, particularly on gases.

Other materials referred to in this catalog

CA	(Acetal, Celcon, Delrin)
FFKM	(Perfluoroelastomers)
FMQ	(Fluorosilicone)
HYT	(Hytrel)
MTBE	(Methyl tertiary-butyl ether)
PA	(Nylon, Zytel)
PA + FV	(Polyamide)
PE	(Polyethylene)
PP	(Polypropylene)
PPS	(Polyphenylene Sulfide, Ryton)
PUR	(Polyurethane)
UR	(Urethane)
VMQ	(Silicone)

Viton and Teflon are registered Trademarks of DuPont Co. Fluorel is a registered Trademark of 3M.

Material Selection Guide for Commonly Used Fluids

Fluids	Qualifying Service Information	Materials of Construction and Ordering Information (Refer to List Price Schedule for availability and prices of Special Features)
Acetic Acid	Standard strengths of water solution are: 28, 56, 70, 80, 85, 98%.	For solutions of 40% or less, use stainless steel Type 316 Normally Closed valve with EPDM elastomers. Add suffix "E" to catalog number.
Acetic Acid, Glacial	99.9% solid.	Use appropriate ball valve with ASCO 3 or 4-way auxiliary air pilot valve.
Acetone	Colorless, flammable liquid with mint-like odor. Soluble in water and ether.	Standard catalog valves with EPDM elastomers. Add suffix "E" to catalog number. PTFE or metal seated valves also used.
Acetylene	A colorless, highly flammable gas used for welding and flame cutting of metals, and for producing other chemicals. If moisture is present, copper, silver, and alloys containing more than 66% copper are not suitable.	Standard catalog aluminum, brass, or stainless steel valves. Specify aluminum shading coil. Do not use bar stock brass valves.
Air, Lubricated (Shop Air)	Most sources of air carry lubrication from pumps and other equipment. Others are directly lubricated in lines.	Standard resilient seated catalog valves. For synthetic diester lubricating oils, FKM seals may be required. <i>Consult local ASCO office.</i>
Air (or Gas), Dry, Unlubricated	Used in instrument air applications and telephone lines where moisture and oil cannot be tolerated.	Special constructions required. Refer to Long-Life Solenoid Valve Constructions.
Alcohol, Ethyl (Denatured Alcohol)	A grain alcohol commonly used as solvent. Also used as a radiator antifreeze and rocket fuel.	Standard resilient seated catalog valves
Alcohol, Methyl (Methanol)	A flammable wood alcohol used in automotive antifreeze, general solvent, aviation, and rocket fuel.	Standard catalog constructions; however, where high purity of liquid is essential, use stainless steel designs.
Ammonia (Anhydrous or Dissociated)	Used in refrigeration. Other uses include: for cleaning and bleaching, for etching aluminum, and in chemical processing. Presence of slight trace of water moisture can be harmful to brass.	Stainless Steel construction with aluminum shading coil and CR elastomers are required. Specify aluminum shading coil. Add prefix "X" and suffix "J" to catalog number.
Argon	The valves must be free of contaminants when filling incandescent lamps, luminescent tubes, gas thermometers, etc. Also used as an inert shielding gas in welding equipment.	Standard catalog aluminum and brass valves used in connection with welding equipment. Most other applications require stainless steel valves, specially cleaned to avoid contamination. Specify AP-1-005.
Benzene, (Benzol)	Solvent used for waxes, resins, rubber, and other organic materials. Also employed as a fuel or for blending with gasoline or other fuels.	Standard catalog valves with FKM, or PTFE disc and gasket.
Butane	One of the principal LP gases. Used as fuel for household and other industrial purposes. Also a refrigerant and a propellant in aerosol cans.	Special construction required. Refer to Combustion Section.

Fluids	Qualifying Service Information	Materials of Construction and Ordering Information (Refer to List Price Schedule for availability and prices of Special Features)
Carbon Dioxide (Gas or Liquid) (CO ₂)	Also known as carbonic anhydride. Used in industrial refrigeration and refrigeration of foods and carbonated beverages. Also, as a fire extinguisher and inert atmosphere in welding equipment.	For gas pressures below 100 psi, use standard valves with NBR discs. Above 100 psi, use Series 8264, especially designed for this service.
Carbon Tetrachloride ("Carbona")	Also known as tetrachloromethane. Mainly used as a metal degreasing agent. Also used in fire extinguishers. It is a general solvent and dry-cleaning medium. Its fumes are highly toxic and should be handled in well-ventilated areas.	Standard catalog brass valves with PTFE or FKM discs. Add suffix "T" or "V" to catalog number. Diaphragm valves must be equipped with FKM parts. Add suffix "V" to catalog number. Metal seated valves also used.
Caustic Soda	See "Sodium Hydroxide."	
Cellulube	One of the phosphate ester lubricating fluids which are fire resistant.	Standard catalog designs with EPDM elastomers. Add suffix "E" to catalog number. PTFE or metal seated valves also used.
Chlorine	Chlorine has a powerful suffocating odor and is strongly corrosive to organic tissues and to metals. Uses include: for bleaching textiles and paper pulp, but it is also used for the manufacture of many chemicals.	Use appropriate ball valve with ASCO 3 or 4 way auxiliary air pilot valve.
City Gas	See "Natural" and "Manufactured Gas."	
Coffee	Automatic or semiautomatic dispensing equipment.	Stainless steel or plastic valves. For FDA approved elastomers, consult your local ASCO office.
Coke Oven Gas (Bench Gas; Coal Gas)	Flammable gas used in domestic and industrial heating.	Standard steel or stainless steel valves with FKM elastomers.
Coolant Oil	Oil used in automatic screw machines and related equipment as cutting oils or coolants. Usually contain suspended solids.	Consult your local ASCO office.
Diesel Fuel	Petroleum oil used as fuel for diesel engines.	Standard resilient seated catalog valves with FKM seating.
Ethylene Glycol (Ethylene Alcohol) "Prestone"	Also known as glycol. Used in permanent antifreeze solutions, brake fluids, and as a dye solvent.	Standard resilient seated catalog valves.
"Freon [®] " Solvents "MF," "TF," and "BF"	Trademark for a solvent which is commonly used in ultrasonic degreasers for removing oil, common grease, and dirt on metal or plastic parts.	Standard catalog items with metal-to-metal seating, or NBR elastomers only.

Fluids	Qualifying Service Information	Materials of Construction and Ordering Information (Refer to List Price Schedule for availability and prices of Special Features)
Fuel Oil (Light) Nos. 1, 2, 3	"Distillate" petroleum oil used in combustion applications without preheating.	Refer to Combustion Section.
Fuel Oil (Heavy) Nos. 4, 5, 6	Heavy "Bunker" fuel oil. Usually preheated to 135°F or more for combustion.	Refer to Combustion Section.
Gasoline	Special or high-test gasolines have additives or aromatics that affect synthetic rubber by excessive swell, or extraction of plasticizers.	Standard catalog valve constructions with FKM elastomers. Add suffix "V" to catalog number. If MTBE additive is present in gasoline, then use FFKM elastomers. Metal seated valves also used.
Helium	An inert gas used in heat treating, purging, and welding.	Standard resilient seated catalog valves.
Hydraulic Oil	Petroleum base only — viscosity usually 50 SSU or 300 SSU. For fire-resistant hydraulic oils, see "Cellulube," "Pydraul," and "Skydrol."	Standard resilient seated catalog valves.
Hydrochloric Acid	Also known as muriatic acid. Corrosive chemical.	Use an appropriate ball valve with ASCO 3 or 4 way auxiliary air pilot valve. For low pressure, small flow, and a maximum concentration of 20%, refer to Shielded Core valves.
Hydrogen	A highly flammable gas when exposed to air.	Standard resilient seated catalog valves with soft seats.
Jet Fuels (JP1 through 8). For others, consult your local ASCO office.	These fuels are used in jet engines and are petroleum products, similar to kerosene. Some jet fuels contain substantial quantities of aromatics which affect most synthetic rubbers.	Standard catalog valves with FKM elastomers. Add suffix "V" to catalog number. PTFE and metal seated valves also used.
Kerosene	Generally used as a solvent for cleaning purpose and as a heating fuel.	Standard catalog valve with FKM elastomers. Add suffix "V" to catalog number.
LP Gas	See "Propane."	Refer to Combustion Section.
Liquid Natural Gas, Nitrogen, and Oxygen		Refer to Cryogenic Valves.
Manufactured Gas	Refine coke oven gas used in city applications.	Refer to Combustion Section.
Mercury	Uses: mercury cells and other electrical apparatus; mercury vapor boilers, lamps, barometers, thermometers, etc.	Use stainless steel body. Valve must be mounted upside down. Special construction required. Consult your local ASCO office with application details.
Methyl Ethyl Ketone (MEK)	Used in lacquers, paint removers, cements and adhesives. It is a flammable liquid.	Standard catalog valves with EPDM elastomers. Add suffix "E" to catalog number. PTFE or metal seated valves also used.
Naphtha	A coal-tar solvent.	Use NBR or FKM elastomers. For FKM elastomer, add suffix "V" to catalog number.
Natural Gas	Common heating fuel.	Refer to Combustion Section.

Fluids	Qualifying Service Information	Materials of Construction and Ordering Information (Refer to List Price Schedule for availability and prices of Special Features)
Nitric Acid (aqua fortis or azotic acid)	Normally, concentrations are 60% nitric and 40% water.	Stainless steel valves with aluminum shading coil and PTFE disc. Add suffix "T" to catalog number. Metal seated valves also used. Maximum temperature at which we can offer valve is 100°F.
Nitric Acid-Red Fuming	Red fuming is more than 86% nitric acid. These can be handled with all stainless steel valves.	
Nitric Acid-White Fuming	White fuming, which is pure to 97.5% acid, and nitric acid vapors are very difficult to handle.	For white fuming acid, use appropriate ball valve with ASCO pilot.
Nitrogen	An inert gas used in heat treating, purging, and welding.	Standard resilient seated catalog valves.
Oils, Lubricating or Motor	Common motor oils known as SAE oils and synthetic lube oils, etc.	Standard catalog valves for 300 SSU maximum. For higher SSU, consult your local ASCO office. For compressor service involving refrigerants, consult your local ASCO office for elastomer selection.
Oxygen, Gas	Used in conjunction with various fuels in furnaces, ovens, cutting torches, welding, and heat treating. A nonflammable gas. Contact with hydrocarbons will result in spontaneous combustion.	Metal body valves with FKM or CR elastomers, specially cleaned to avoid contamination with hydrocarbons. Add suffix "N" to catalog number.
Perchloroethylene (Tetrachloroethylene) "Perk"	Used as a dry-cleaning solvent and in vapor degreasing equipment.	Standard catalog items with FKM elastomers. Add suffix "V" to catalog number. Special piston valves available. Do not use diaphragm valves. Consult your local ASCO office.
Phosphoric Acid	Also known as orthophosphoric acid. Used in pickling and rust-proofing metals, soft drinks and flavoring syrups, as well as pharmaceuticals.	For concentration of up to 20% and temperatures of 100°F, use 300 series stainless steel with ethylene propylene, FKM, or NBR elastomers.
Photographic Solutions	Also known as sodium thiosulfate or hypo. Most metals corrode sufficiently to cause solution contamination.	For low pressure, small flow, and low concentrations (20% max.), refer to Shielded Core Valves.
Potassium Sulfate	Used in fertilizers. Also in aluminum and glass manufacturing.	Standard stainless steel catalog valves.
Propane Gas	One of the principal LP gases commonly used in grain dryer applications, and a bottled gas for heating and cooking.	Special construction required. Refer to Combustion Section.

Fluids	Qualifying Service Information	Materials of Construction and Ordering Information (Refer to List Price Schedule for availability and prices of Special Features)
"Pydraul" (Monsanto)	A trademark for a series of fire-resistant hydraulic fluids. Used in automatic welding machines, hydraulic presses, and air compressors. Also used in die-casting machines, forging, and extrusion presses.	Standard catalog items with FKM elastomers. Add suffix "V" to catalog number. PTFE or metal seated valves also used.
Refrigerants, CFC (chlorofluorocarbon) "Freon®"	CFCs are used as refrigerants; as blowing agents in the manufacture of insulation, packaging, and cushioning foams; as cleaning agents for metal and electronic components; and in many other applications. CFCs contain chlorine and have been targeted by the EPA to be phased out.	Refrigerants require special selection of elastomers. Consult your local ASCO office.
Refrigerants, HFC (hydrofluorocarbon) "Suva®"	Environmentally acceptable alternative to CFC. Contains no chlorine.	Refrigerants require special selection of elastomers. Consult your local ASCO office.
"Skydrol"	Trademark for fire-resistant jet aircraft hydraulic fluid.	Standard catalog items with EPDM elastomer. Add suffix "E" to catalog number. PTFE or metal seated valves also used.
Sodium Hydroxide (Caustic Soda)	Used in pulp and paper industry. Included in detergents and soap, also in textile processing. Solutions range between 50% and 73% commercial.	Stainless steel valves with EPDM elastomers. Add suffix "E" to catalog number. Stainless steel or PTFE seated valves also used.
Sour Gas	See "Coke Oven Gas."	
Steam Condensate	This is return condensate from steam boilers, which has various degrees of dissolved carbon dioxide or oxygen. Temperature is normally high to boiling point.	Brass valves suitable with EPDM elastomers. See Series 8210 and 8222 Hot Water Service Listings. Use suffix "E" on all others.
Stoddard Solvent	This is a dry-cleaning solvent of usually high-purity naphtha, clear and free of undissolved water. A coal-tar solvent.	Standard catalog items.
Sulfuric Acid	An oily, highly corrosive liquid oxidizing organic materials and most metals. It is used for pickling and cleaning metals in electric batteries and in plating baths, for making explosives and fertilizers.	Use an appropriate ball valves with ASCO 3 or 4 way auxiliary air pilot valve. For low pressure, small flow, and a concentration of up to 60%, refer to Shielded Core Valves.
Toluene (Toluol)	Also called methyl benzene or methyl benzol. One of the coal-tar solvents. Used in aviation and high octane gasolines. Also a solvent for paints, coatings, resins, etc. It is a flammable liquid.	Standard catalog valves with FKM disc and gasket. Add suffix "V" to catalog number.

Fluids	Qualifying Service Information	Materials of Construction and Ordering Information (Refer to List Price Schedule for availability and prices of Special Features)
Trichloroethylene ("Carbona" or "TRIAD")	Common degreasing solvent, noncombustible, but very toxic. Adequate ventilation required.	Standard brass catalog valves, if dry, use FKM elastomers (add suffix "V" to catalog number). If moisture is present, use stainless steel. Metal and PTFE seated valves also used.
Turpentine	Solvent or thinner for paints, varnishes, and lacquers. Also, a rubber solvent and reclaiming agent. The liquid is volatile.	Standard catalog valves with FKM elastomers. Add suffix "V" to catalog number.
Vacuum		Refer to Vacuum Valves.
Vegetable Oils	Edible oils extracted from seeds, fruits, or plants, such as peanut oils, cottonseed oils, etc.	Standard resilient seated catalog valves. For FDA approved elastomers, consult your local ASCO office.
Vinegar	A diluted impure solution of acetic acid.	Stainless steel valves with EPDM elastomers (FKM elastomers may also be used). Add suffix "E" to catalog number. For FDA approved elastomers, consult your local ASCO office.
Water, Boiler Feed	Commonly treated water with inhibitors to avoid corrosion of boiler tubes.	Standard stainless steel catalog valves with FKM elastomers. Add suffix "V" to catalog number.
Water, Distilled or Deionized	A purified water, sometimes called deionized water, neutral and free from contaminants.	Stainless steel valves with EPDM elastomers. Add suffix "E" to catalog number. Stainless steel or PTFE seated valves also used.
Water, Fresh		Standard resilient seated catalog valves. Aerated water, which is slightly acidic, will cause seat erosion by process known as dezincification. Stainless steel or plastic valves should then be selected.
Water, High Pressure	When handling water above 500 psi, erosion and water hammer must be considered.	Special designs for car wash applications, etc. Consult your local ASCO office.
Water, Hot	Water above 200°F: Often flashes to steam due to regulators or other line restrictions. Below 200°F, this change of state is unlikely.	Standard catalog designs suitable to temperatures listed in catalog. Also see Series 8210 and 8222 Hot Water Service listings. For temperatures exceeding those listed, consult your local ASCO office.
Water, Sea, Brine, Brackish	Difficult to handle due to galvanic corrosion.	Use appropriate ball valve with ASCO air pilot valve.

Electronically Enhanced Solenoids (Next Generation)

All RedHat Next Generation solenoid valves are rated for continuous duty under the operating conditions outlined within this section.

Coil Operating Voltage Ranges

All coils are designed for industrial operating voltages and can be used on the following voltage ranges:

Voltage Range	Minimum Voltage	Maximum Voltage
100-240V/50 or 60Hz/DC	85	264
24-99V/50 or 60Hz/DC	20.4	109
12-24/DC only	10.4	26.4

The coils with voltage ranges of 100-240 and 24-99 have three lead wires, 24 inches long (2 red for power input, and one green lead for grounding where necessary). These two versions are not polarity sensitive.

The coil with a voltage range of 12-24/DC has 3 lead wires, one red, one black, and one green. This coil is polarity sensitive. The red lead is the positive, black is the negative, and green is the ground wire. This solenoid is also polarity protected. Reversing the polarity will not damage the coil, but the coil will not function until the correct polarity is applied.

Note: The 100-240 voltage range is also suitable for battery charging circuits designed around a 125/DC nominal voltage range.

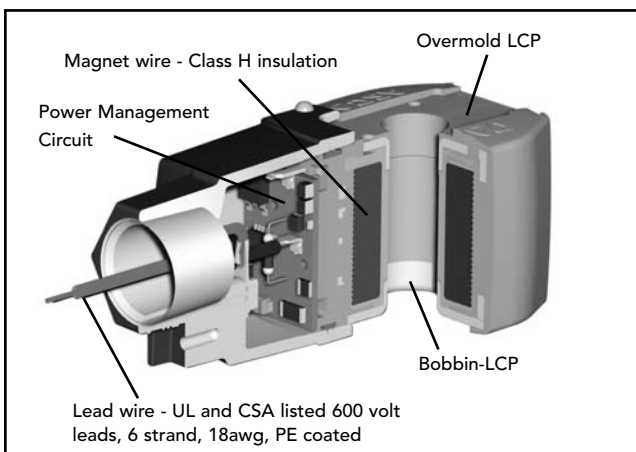

Electrical Specifications

2 Watt Electronic Coils	Type
Maximum Ambient Temperature	140°F
Maximum Cycle Rate	1 Operation/ Second
Standard Coil Class of Insulation	H

Power Consumption

The Next Generation solenoid nominal power rating is 2 watts. Depending on the input voltage applied, the actual power rating may vary. Please use the charts below to determine your actual power rating.

Version
100-240/50-60Hz

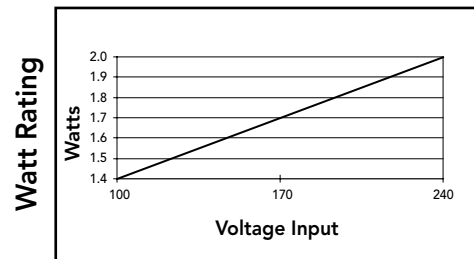

Version
24-99/50-60Hz

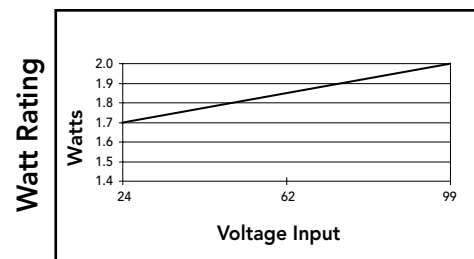

Version
12-24/DC

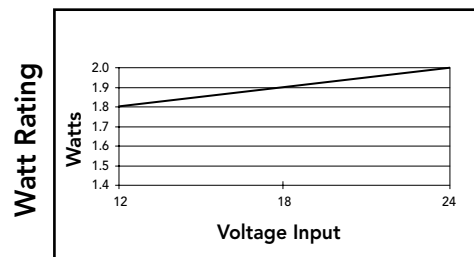

The advanced technology used in the Next Generation coil includes electronic circuitry which may limit the compatibility with certain control system components. The following issues need to be considered when specifying an output card or device to operate the Next Generation coil. An initial inrush current spike is drawn by the Next Generation coil. This inrush spike is 72 msec in duration, which is sufficient time for the core to reach the plugging. The electrical requirement then drops to the holding value.

Inrush Current: The power source, wiring, and output device used need to have surge ratings equal to or greater than the inrush current value (appropriate to the voltage range) specified in the table below.

Inrush Current Rating	
Coil Version	Peak Inrush Current (Amps)
12-24/DC	3.2
24-99/50-60Hz/DC	1.4
100-240/50-60Hz/DC	0.32
Maximum Duration = 72 ms	

Holding Current: The power source, wiring, and output device used need to have continuous current ratings equal to or greater than the holding current value (appropriate to the voltage range) specified in the table below.

Holding Current Rating			
Coil Version	Input Voltage	Average Holding Current (Amps)	Average Holding Volt-Amps (VA)
12-24/DC	12	0.340	4.0
	24	0.250	6.0
24-99/50-60Hz/DC	24	0.170	4.0
	99	0.100	10.0
100-240/50-60Hz/DC	100	0.040	4.0
	240	0.032	7.5

Leakage Currents: The leakage current is defined as a current that is supplied from an output device when the device is in its off or de-activated state. Operation of Next Generation coil in a system that utilizes supervisory currents is not recommended.

Maximum Leakage Current	3 mA
-------------------------	------

Solenoid Enclosures

The Next Generation solenoid coil is fully encapsulated using Dupont™ Zenite® Liquid Crystal Polymer resin (LCP). Zenite (LCP) is a thermoplastic polyester resin which exhibits several advantages over other thermoplastics. The advantages include excellent resistance to a wide range of organic solvents and automotive fluids*, resistance to impact, and long term retention of properties at continuous-use temperatures.

*Chemical resistance of Zenite LCP may not be suitable for all applications. Zenite LCP is not suitable for caustic solution. *Please consult ASCO for appropriate product solutions.*

Zenite is a registered Trademark of Dupont Co.



RedHat Next Generation Solenoids are available as:

General Purpose/Watertight – Intended for indoor and outdoor use and provides protection classifications from NEMA Types 1 through 4X.

Class I, Division 2 for Hazardous Locations/Watertight – Meets Types 1 through 4X and is UL listed and CSA certified for Class I, Division 2, Groups A, B, C, and D and Class II, Division 2, Groups F and G. Operating temperature code T4A (120°C).

Valve Specifications

Maximum Ambient Temperature

The maximum ambient temperature is 140°F (60°C). This limit is based on continuous energization with the maximum fluid temperatures as shown on each catalog page.

Response Time

Response time from fully closed to fully open or vice versa depends on valve size, operating mode, fluids, temperature, inlet pressure, and pressure drop. The response times for Next Generation are defined as:

- Small direct acting valves – 10 to 60 msec
- Large direct acting valves – 25 to 90 msec

Internally pilot operated valves:

- Small diaphragm types – 20 to 100 msec
- Large diaphragm types – 80 to 150 msec
- Small piston types – 80 to 150 msec
- Large piston types – 105 to 200 msec

Operation on liquids has relatively little effect on small direct acting valves, however, response times of large direct acting and internally piloted valves may be lengthened by 50% to 100%.

Manual Operators

Manual operators are provided to operate the valves manually when electric actuation is not provided. There are two basic types of manual operators, momentary and maintained. To determine which type of manual operator is available for your valves, please see the Optional Features Chart on the relevant valve catalog page. Once it is determined that the subject valve can accommodate a manual operator, the chart below will tell you the type of manual operator. The chart also references the relevant cutaway illustration.

Series Number	Const. Ref.	Manual Operator Suffix	Manual Operator Type	Illustration Number
8030	8	MO	Maintained	3
8210	4, 7, 10, 11, 12	MO	Maintained	2
8262	1	MS	Maintained	6
8263	1	MS	Maintained	6
8314	1	MS	Maintained	6
8316	5, 6	MO	Maintained	2
8320	2	MO	Momentary	1
8320	2	MS	Maintained	6
8321	4	MO	Momentary	1
8321	4	MS	Maintained	3
8344	1, 3, 4	MO	Maintained	2
8345	2	MO	Maintained	5

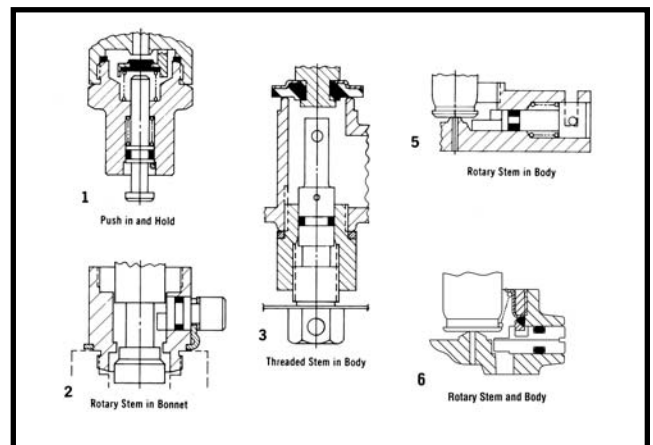

Valve Parts in Contact with Fluids							
Catalog Number	Body	Seals and Discs	Disc Holder	Core Guide	Springs	Shading Coil	Stem
8030P003	Brass	NBR	-	-	302 Stainless Steel	-	-
8030P083	Brass	NBR	-	-	302 Stainless Steel	-	-
8210P004	Brass	NBR	-	-	302 Stainless Steel	-	-
8210P007	Brass	NBR	-	-	302 Stainless Steel	-	-
8210P008	Brass	NBR	-	-	302 Stainless Steel	-	-
8210P022	Brass	NBR	PA	-	302 Stainless Steel	-	-
8210P033	Brass	NBR	PA	-	302 Stainless Steel	-	-
8210P034	Brass	NBR	PA	-	302 Stainless Steel	-	-
8210P035	Brass	NBR	PA	-	302 Stainless Steel	-	-
8210P087	304 Stainless Steel	NBR	-	-	302 Stainless Steel	-	-
8210P088	304 Stainless Steel	NBR	-	-	302 Stainless Steel	-	-
8210P093	Brass	NBR	-	-	302 Stainless Steel	-	-
8210P094	Brass	NBR	-	-	302 Stainless Steel	-	-
8210P095	Brass	NBR	-	-	302 Stainless Steel	-	-
8210P100	Brass	NBR	-	-	302 Stainless Steel	-	-
8223P003	Brass	NBR, PA, PTFE	-	-	302 Stainless Steel	Copper	-
8223P005	Brass	NBR, PA, PTFE	-	-	302 Stainless Steel	Copper	-
8223P010	304 Stainless Steel	PTFE, NBR	-	-	302 Stainless Steel	Silver	-
8223P025	Brass	NBR, PA, PTFE	-	-	302 Stainless Steel	Copper	-
8223P027	Brass	NBR, PA, PTFE	-	-	302 Stainless Steel	Copper	-
8262R202	Brass	NBR	-	-	302 Stainless Steel	Copper	-
8262R208	Brass	NBR	-	-	302 Stainless Steel	Copper	-
8262R212	Brass	NBR	-	-	302 Stainless Steel	Copper	-
8262R220	304 Stainless Steel	NBR	-	-	302 Stainless Steel	Silver	-
8262R226	304 Stainless Steel	NBR	-	-	302 Stainless Steel	Silver	-
8262R230	304 Stainless Steel	NBR	-	-	302 Stainless Steel	Silver	-
8262R232	Brass	NBR	-	-	302 Stainless Steel	Copper	-
8262R261	Brass	UR	-	-	302 Stainless Steel	Copper	PA
8262R262	Brass	NBR	-	-	302 Stainless Steel	Copper	PA
8262R263	Brass	NBR	-	-	302 Stainless Steel	Copper	PA
8262R265	Brass	NBR	-	-	302 Stainless Steel	Copper	PA
8314R035	Brass	NBR, FKM	-	CA	302 Stainless Steel	Copper	-
8314R036	Brass	NBR, FKM	-	CA	302 Stainless Steel	Copper	-
8314R121	304 Stainless Steel	NBR, FKM	-	CA	302 Stainless Steel	Silver	-
8316P054	Brass	NBR	CA	CA	302, 17-7PH Stainless Steels	Copper	-
8316P064	Brass	NBR	CA	CA	302, 17-7PH Stainless Steels	Copper	-
8316P074	Brass	NBR	CA	CA	302, 17-7PH Stainless Steels	Copper	-
8317P035	Brass	NBR, FKM, CR	-	CA	302, 17-7PH Stainless Steels	Copper	-
8320P172	Brass	NBR	CA	CA	302, 17-7PH Stainless Steels	Copper	-
8320P174	Brass	NBR	CA	CA	302, 17-7PH Stainless Steels	Copper	-
8320P176	Brass	NBR	CA	CA	302, 17-7PH Stainless Steels	Copper	-
8320P182	Brass	NBR	CA	CA	302, 17-7PH Stainless Steels	Copper	-
8320P184	Brass	NBR	CA	CA	302, 17-7PH Stainless Steels	Copper	-
8320P186	Brass	NBR	CA	CA	302, 17-7PH Stainless Steels	Copper	-
8320P192	Brass	NBR	CA	CA	302, 17-7PH Stainless Steels	Copper	-
8320P194	Brass	NBR	CA	CA	302, 17-7PH Stainless Steels	Copper	-
8321P001	Brass	NBR	CA	CA	302 Stainless Steel	Copper	-
8321P002	Brass	NBR	CA	CA	302 Stainless Steel	Copper	-
8344P070	Brass	NBR	CA	CA	302, 17-7PH Stainless Steels	Copper	-
8344P072	Brass	NBR	CA	CA	302, 17-7PH Stainless Steels	Copper	-
8344P074	Brass	NBR	CA	CA	302, 17-7PH Stainless Steels	Copper	-
8344P076	Brass	NBR	CA	CA	302, 17-7PH Stainless Steels	Copper	-
8344P078	Brass	NBR	CA	CA	302, 17-7PH Stainless Steels	Copper	-
8345P001	Brass	NBR, FKM	-	CA	302, 17-7PH Stainless Steels	Copper	-

Note: All core tubes are 305 Stainless Steel and all cores and plugnuts are 430F Stainless Steel.